

# Rim<sup>®</sup>

NÁVOD K POUŽITÍ  
BEDIENUNGSANLEITUNG  
OPERATING INSTRUCTIONS  
MODE D'EMPLOI  
INSTRUKCJA UŻYTKOWANIA  
HASZNÁLATI ÚTMUTATÓ

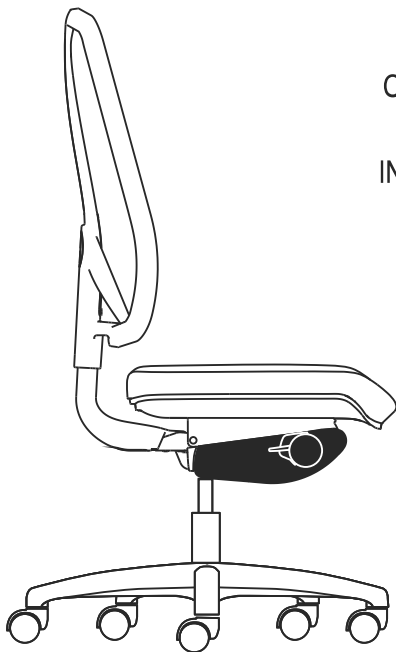

## **SYNCHRO STF**

FLEXi FX 1101  
FLEXi FX 1111  
FOCUS FO 640A  
FOCUS FO 642A  
ANATOM AT 987A

1

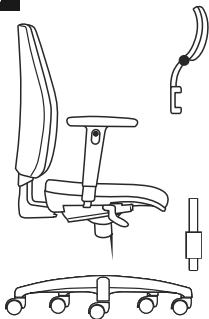

2

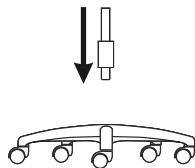

3

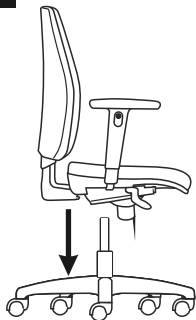

4

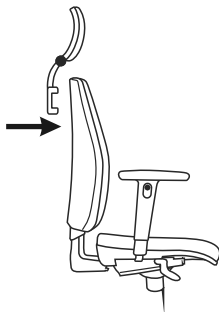

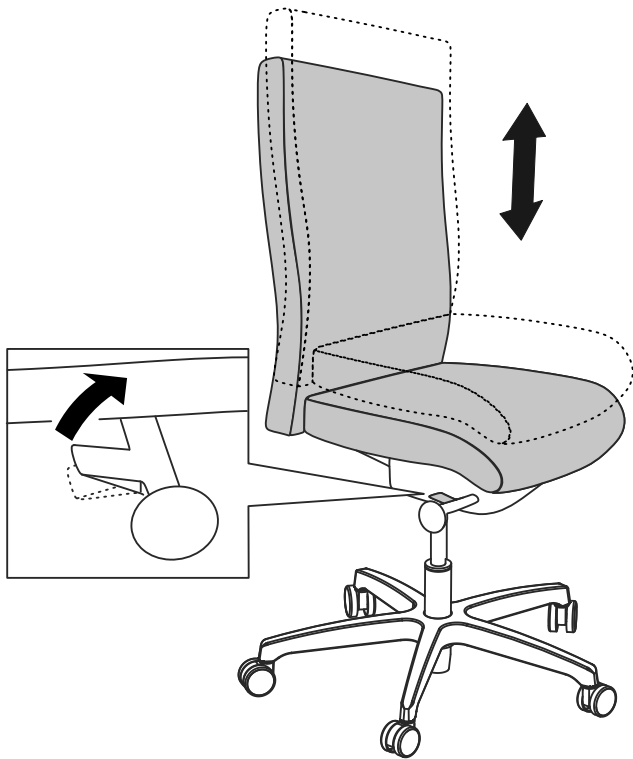

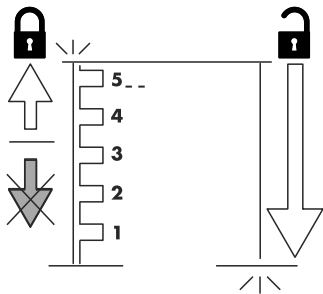
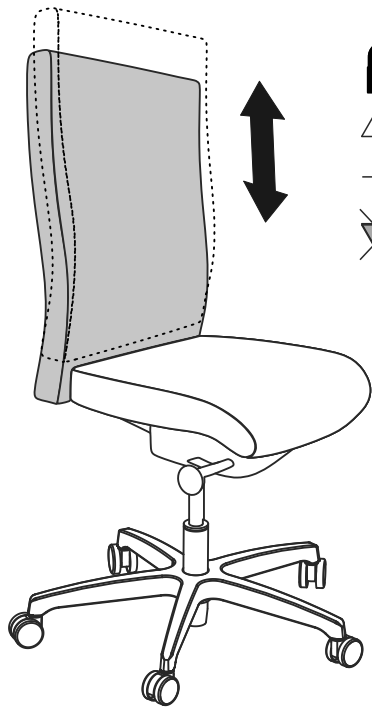

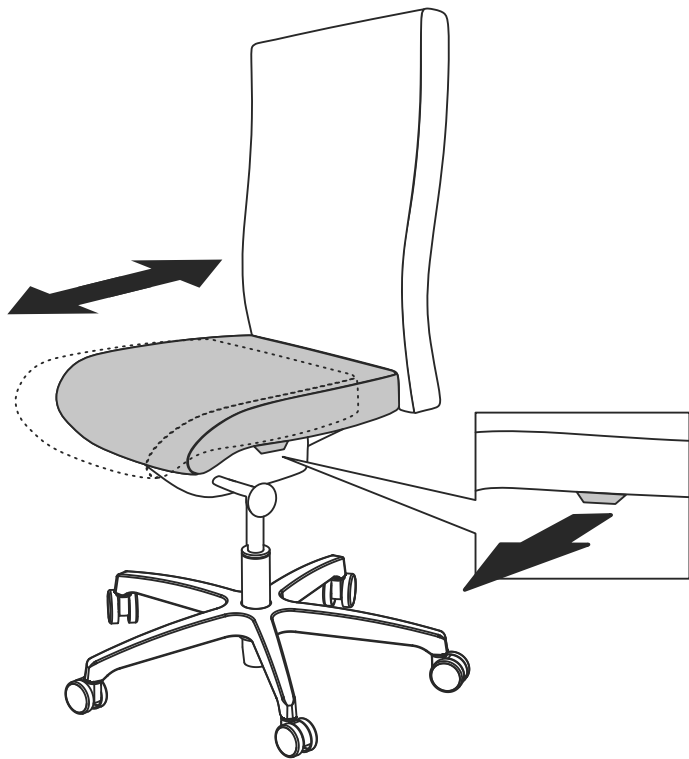

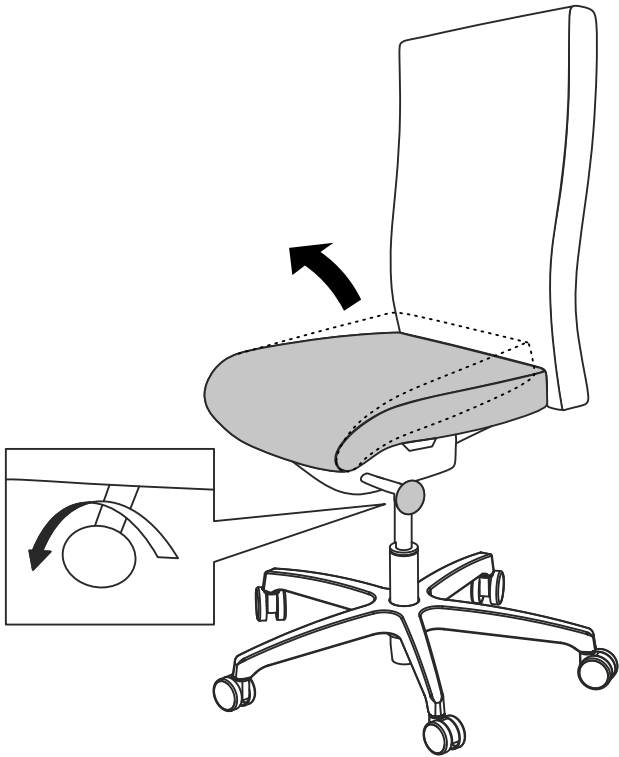

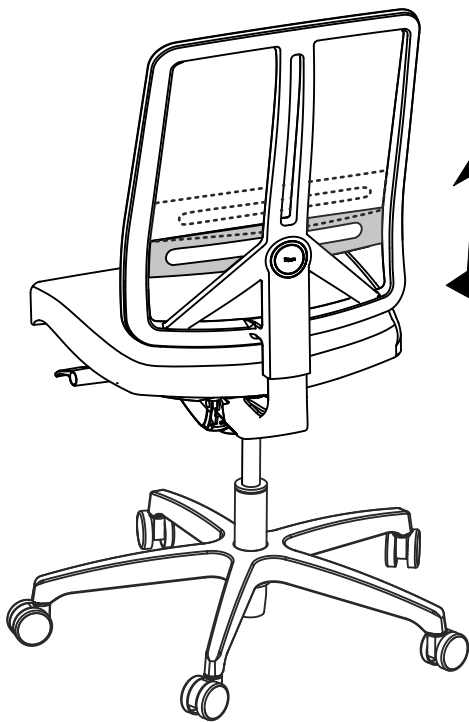

FLEXi FX 1101

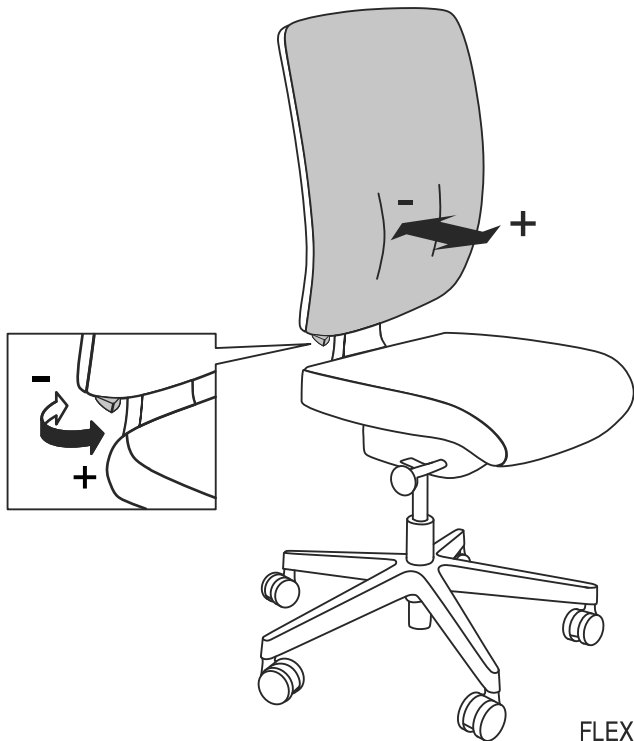

FLEXi FX 1111



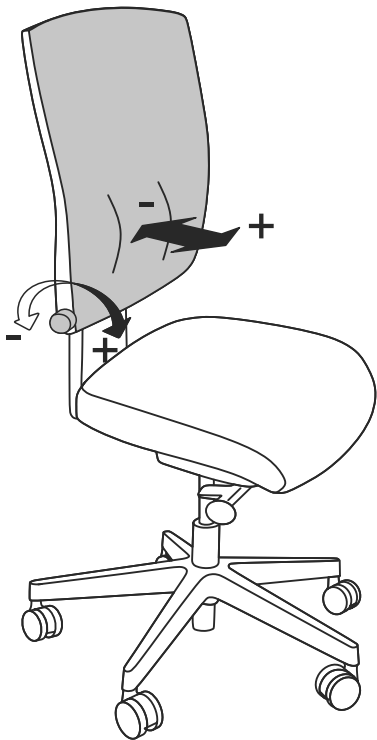

ANATOM AT 987A

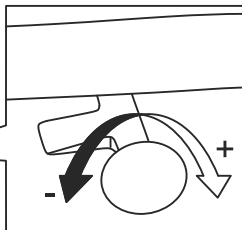
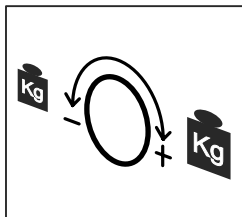
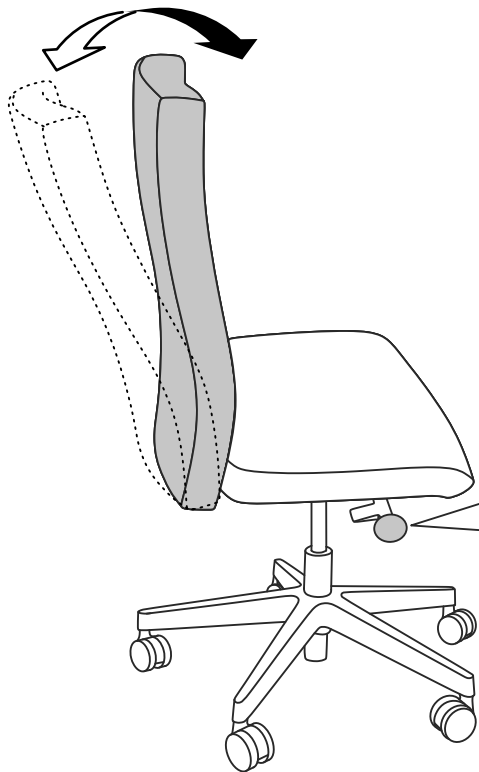

**STOP!**  
**STOP!**

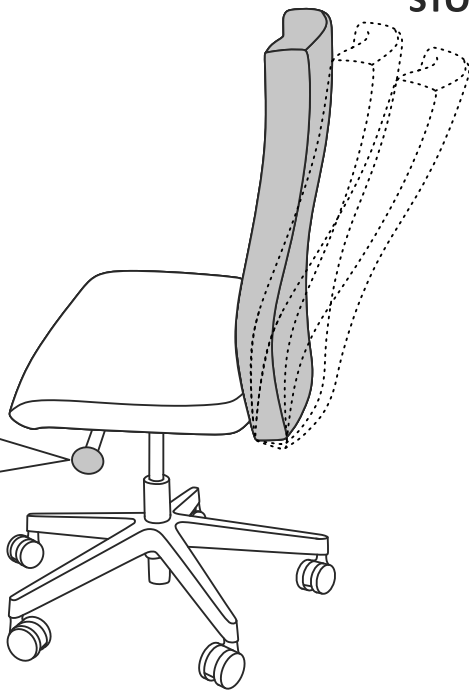
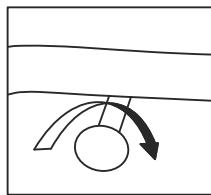

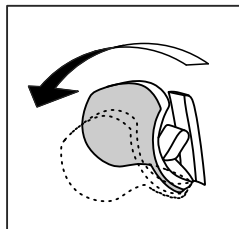
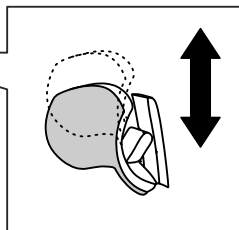
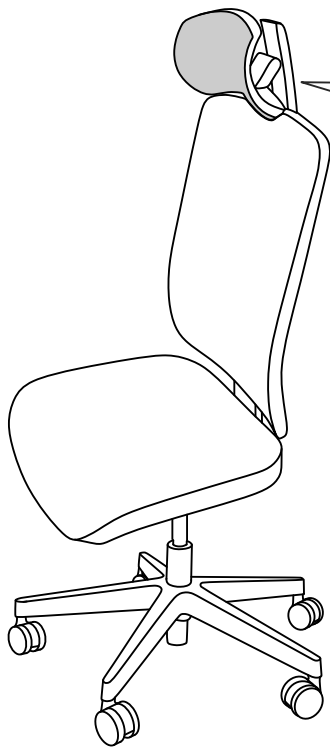

FLEXi FX 1101  
FLEXi FX 1111

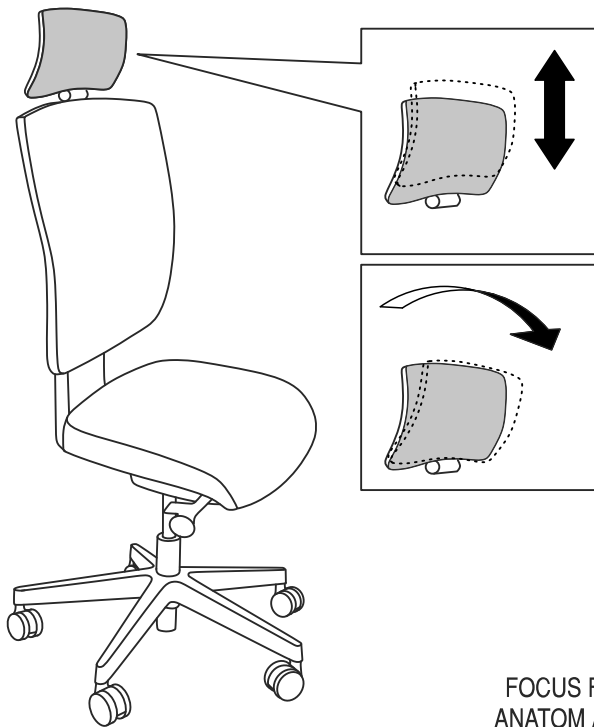

FOCUS FO 642A  
ANATOM AT 987A

# FOCUS FO 642A

82 1F

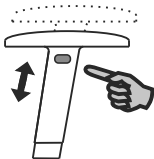

83 3F

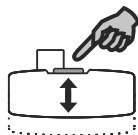
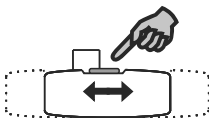
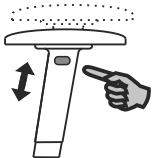

FLEXi FX 1101  
FLEXi FX 1111  
FOCUS FO 640A  
ANATOM AT 987A

91 1F

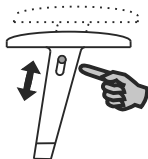

99 2F

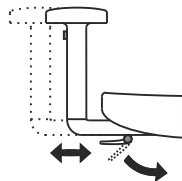
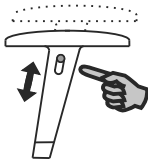

86 3F

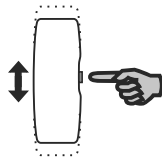
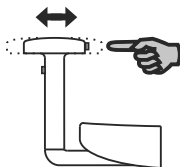
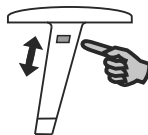

88 4F

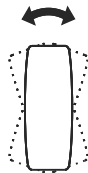
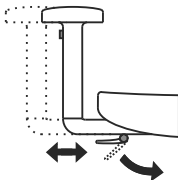
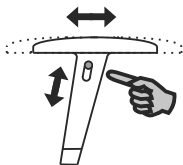

# Rim<sup>®</sup>

**RIM-CZ spol. s r.o.**

Dr. E. Beneše 1015

765 02 Otrokovice

CZECH REPUBLIC

Tel.: +420 577 112 641, -640

Fax: +420 577 101 015

E-mail: [info@rim.cz](mailto:info@rim.cz)

[www.rim.cz](http://www.rim.cz)

