

A concept providing power, data, and media where you want it

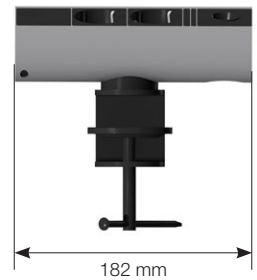

# Axessline Desk

935-D2M0

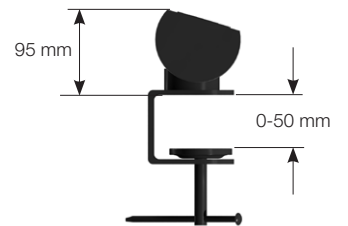

## Connections an arm length away

Axessline provides proximity to workplaces and conference tables. This in a stylish design with high quality and optimal function. Axessline D2M0 is a power strip for mounting on the rear edge of the tabletop, it is equipped with 2 Power and 1 cable feedthrough.

CE CERTIFIED ACCORDING TO CE STANDARD



2 POWER



1 CABLE FEEDTHROUGH



### SPECIFICATIONS

- Fits tabletop max 50 mm.
- 2 Power  
1 Cable feedthrough
- 1.5 m Cable,  
3 x 1.5 mm<sup>2</sup>, black.  
Schuko plug
- Part no. 935-D2M0

# Axessline Desk

935-D2DU

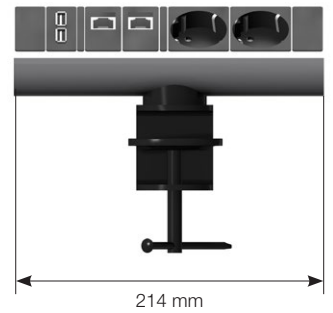
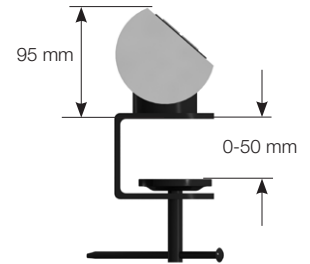

## All connections to the work desk

Axessline provides proximity to workplaces and conference tables. This in a stylish design with high quality and optimal function. Axessline D2DU is a power strip for mounting on the rear edge of the tabletop, it is equipped with 2 Power, 2 data and 2 USB ports.

**CE** CERTIFIED ACCORDING TO CE STANDARD

	3 POWER
	2 DATA
	2 USB-PORTAR (HUB)



### SPECIFICATIONS

- Fits tabletop max 50 mm.
- 3 Power  
2 Data  
2 USB ports
- 1.5 m Cable,  
3 x 1.5 mm<sup>2</sup>, black.  
Schuko plug
- Part no. 935-D2DU

# Axessline Desk

935-D3DU

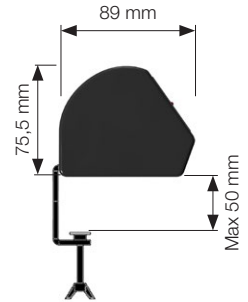
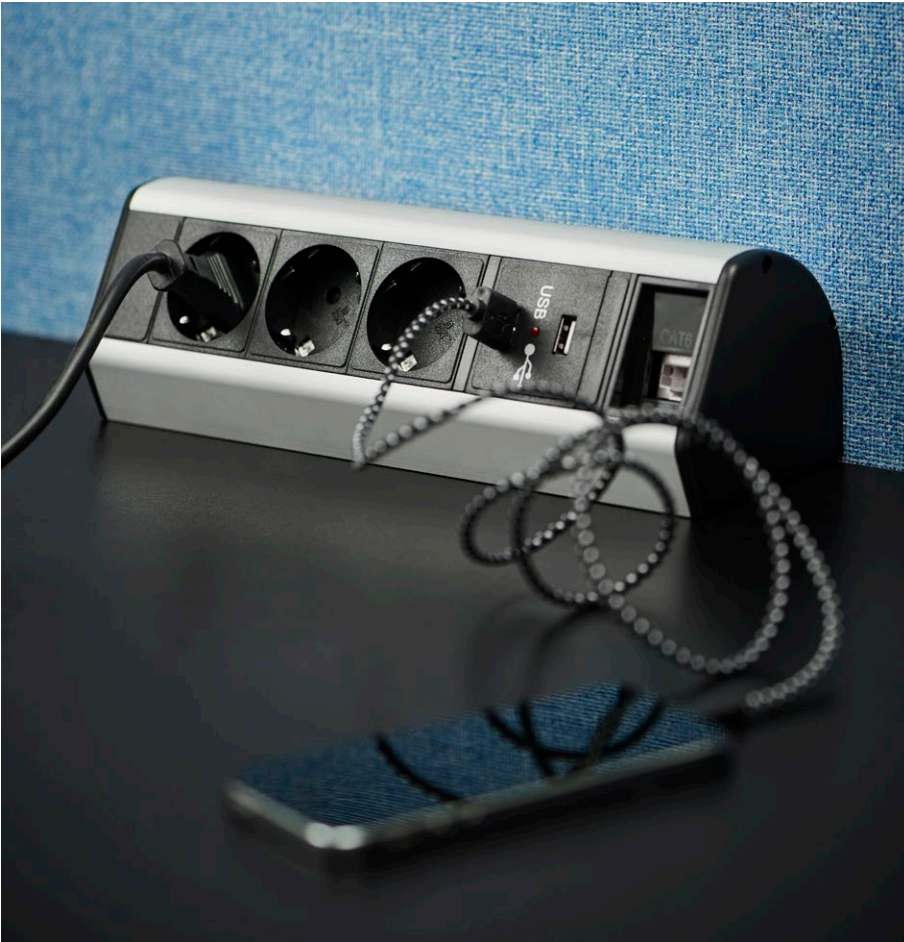



## Manage several users

Axessline provides proximity to workplaces and conference tables. This in a stylish design with optimal function and high quality.

Axessline D3DU a power strip for mounting on the rear edge of the desktop, it has 3 power, 1 data and 2 USB charger.

CE CERTIFIED ACCORDING TO CE STANDARD

	3 POWER
	1 DATA
	2 USB-CHARGER



### SPECIFICATIONS

- Fits tabletop max 50 mm.
- 3 Power (250 V, 16 A, Max 3500 W)  
1 Data (RJ45/CAT6)  
2 USB chargers
- Charger 5 V max 2.1 A USB typ A.
- 1.5 m Cable,  
3 x 1.5 mm<sup>2</sup>, black.  
Schuko plug
- Part no. 935-D3DU

# Axessline Desk

935-I2CD

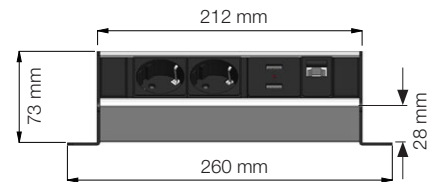
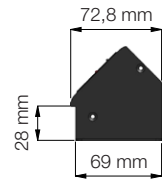

## Immersed in the table

Axessline provides proximity to workplaces and conference tables. This in a stylish design with optimal function and high quality. Axessline I-Desk is a power strip for integrated mounting in tabletop. It has 2 power, 1 data and 2 USB-chargers

CE CERTIFIED ACCORDING TO CE STANDARD

	2 POWER
	1 DATA
	2 USB-CHARGER



### SPECIFICATIONS



- 2 Power (250 V, 16 A, Max 3500 W)
- 1 Data (RJ45/CAT6 - 0.9 m cable)
- 2 USB chargers
- Charger 5 V max 2.1 A USB typ A.
- Cut out in the tabletop is 214 x 69 mm. Corner radius max 3 mm.
- Adjust the thickness of the tabletop 23-26 mm.
- 1.5 m Cable, 3 x 1.5 mm<sup>2</sup>, black. Schuko plug
- Part no. 935-I2CD

# Axessline Quickbox

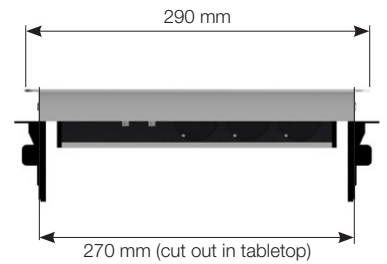
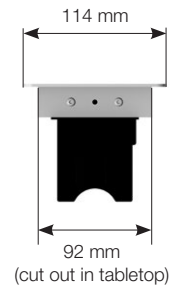
## 935-F200



CE CERTIFIED ACCORDING TO CE STANDARD

	2 POWER
	2 DATA
	2 USB-CHARGER

## Hide the technology

Ever increasing technical requirements call for more functional and convenient IT infrastructure in the office. Axessline QuickBox F200 provide a complete yet easily accessible solution with the simple push of a button. The product's spring mechanism automatically opens its cover to give instant access to a wide range of technical options.



### SPECIFICATIONS

- A compact yet complete technical solution
- Spring-loaded lid opening
- 2 x Power / Schuko plug  
2 x Data / Cat6 / RJ45  
2 x USB charger, 5V, 2100 mA
- Grounded Schuko / 1.5 m  
Max 3500 W, 250 V
- Data cable x 2 / 0.4 m
- Snap fasteners for easy assembly
- Cut-out section 270 x 92 mm
- Part No. 935-F200, "brushed steel"

# Axessline Quickbox

## 935-F300W

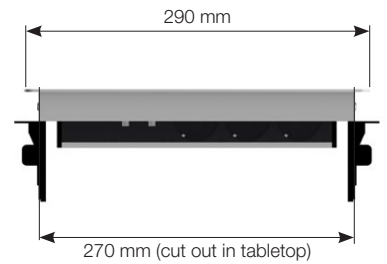
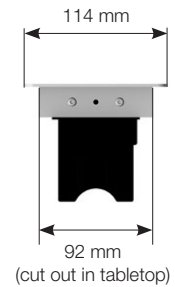

CE CERTIFIED ACCORDING TO CE STANDARD



3 POWER



2 USB-CHARGER

## Hide the technology

Ever increasing technical requirements call for more functional and convenient IT infrastructure in the office. Axessline QuickBox F300W provide a complete yet easily accessible solution with the simple push of a button. The product's spring mechanism automatically opens its cover to give instant access to a wide range of technical options.



### SPECIFICATIONS

- A compact yet complete technical solution
- Spring-loaded lid opening
- 3 x Power / Schuko plug  
2 x USB charger, 5V, 2100 mA
- Grounded Schuko / 1.5 m  
Max 3500 W, 250 V
- Snap fasteners for easy assembly
- Cut-out section 270 x 92 mm
- Part No. 935-F300W, White

# Ecodesk

## 935-ET315G/W



EcoDesk is a practical and elegant option for most workplaces.

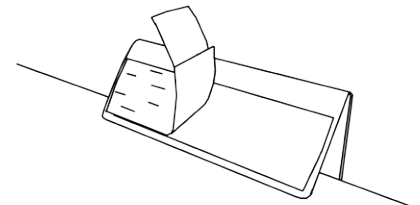
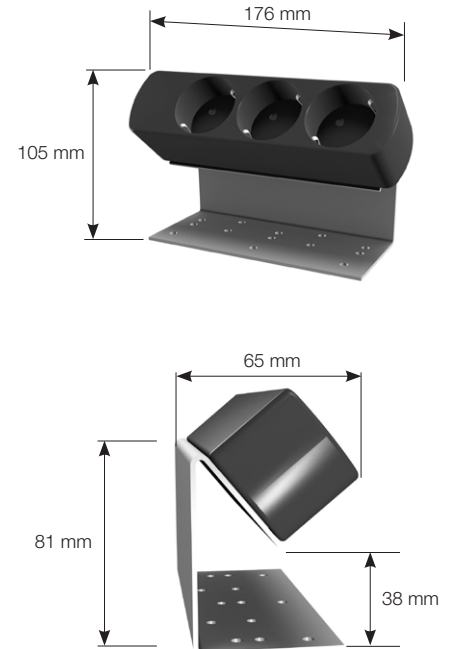

Easy assembly thanks to double sided tape.

## Easy accessible power outlets for a simplified workday

A smart, yet simple design for desk assembly of power outlets on the edge of the workdesk. You do not have to crawl under the desktop or dig in hard-to-reach cable ditches. This will make every day tasks, like connect your cellphone or other electronics much easier. EcoDesk is a priceworthy solution to a ordinary obstacle. Easy assembly with screws and double sided tape. The cable may go left or right for best ergonomics.

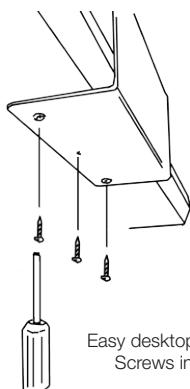

Easy desktop assembly.  
Screws included.

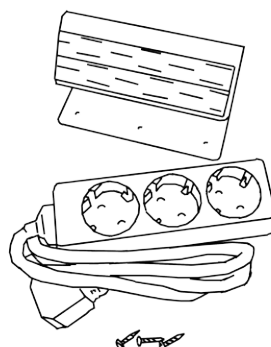

### SPECIFICATIONS

- A smart solution to an every-day problem
- 3 pcs, 45°, grounded outlet
- Available in white and black
- Max. load:  
16A - 230 V, Max 3500 W
- Cable 1.5 m
- Mounting screws included
- Max. height desktop: 38 mm
- Dimensions:  
Width 145 mm  
Length 70 mm  
Height 100 mm
- Part no 936-ET315G, Black  
Part no 936-ET315W, White