

Rim[®]

NÁVOD K POUŽITÍ
BEDIENUNGSANLEITUNG
OPERATING INSTRUCTIONS
MODE D'EMPLOI
INSTRUKCJA UŻYTKOWANIA
HASZNÁLATI ÚTMUTATÓ

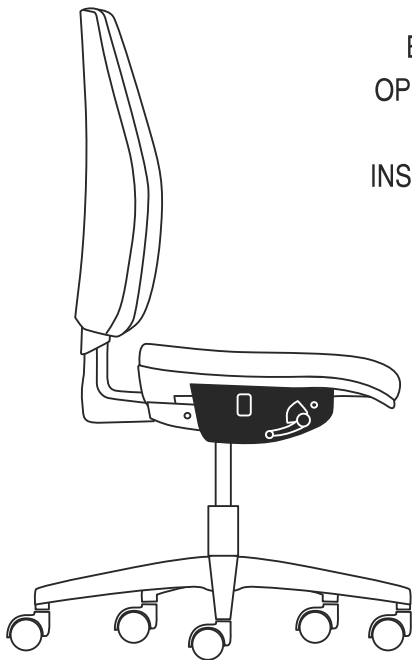

SYNCHRO ST1

FLEXi FX 1104
FLEXi FX 1114
FOCUS FO 642B
ANATOM AT 985A
ACTIVE AC 954A
NET NT 676A
EASY PRO EP 1204
ADAPT AD 971A

1

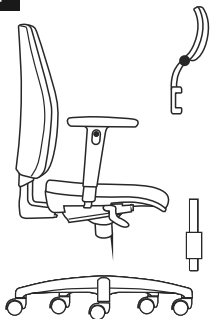

2

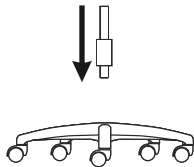

3

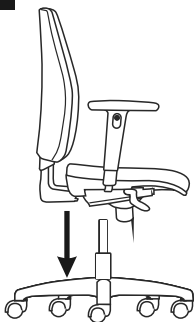

4

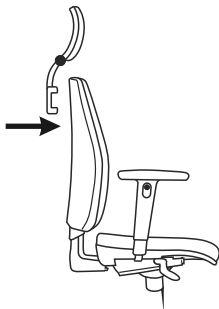

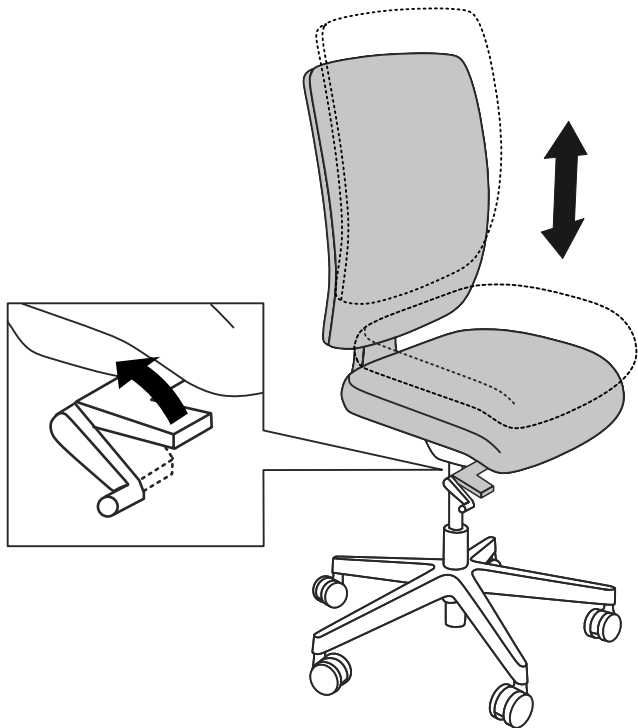

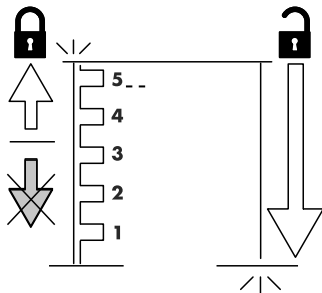
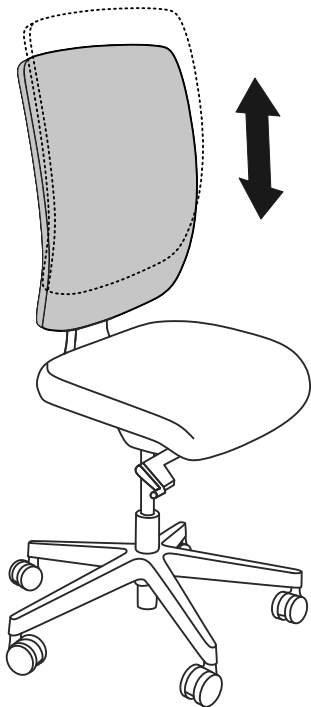

FLEXi FX 1104
FLEXi FX 1114
FOCUS FO 642B
ANATOM AT 985A
ACTIVE AC 954A
ADAPT AD 971A

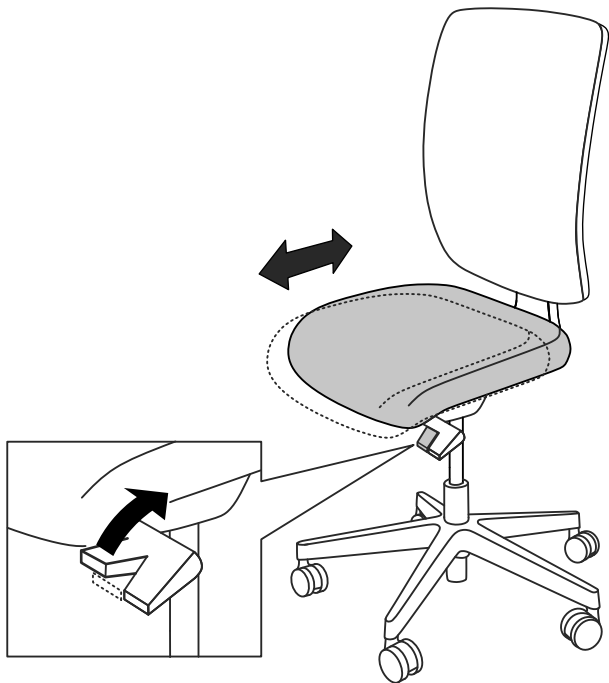

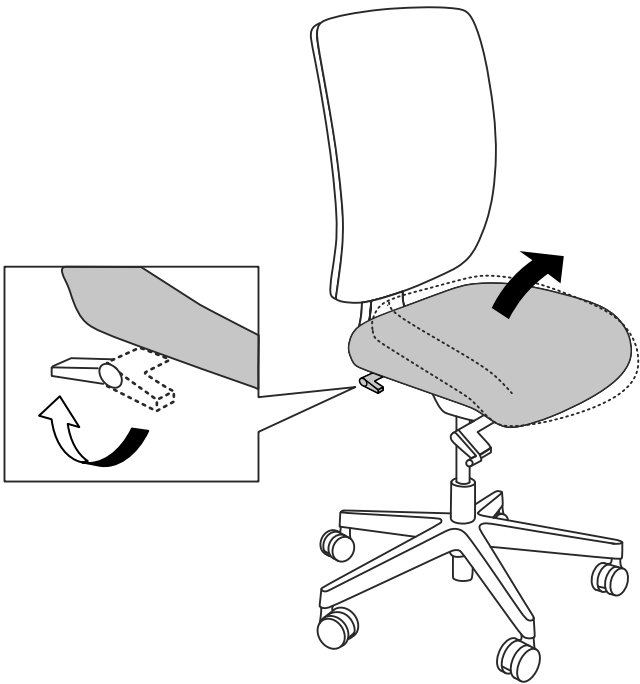

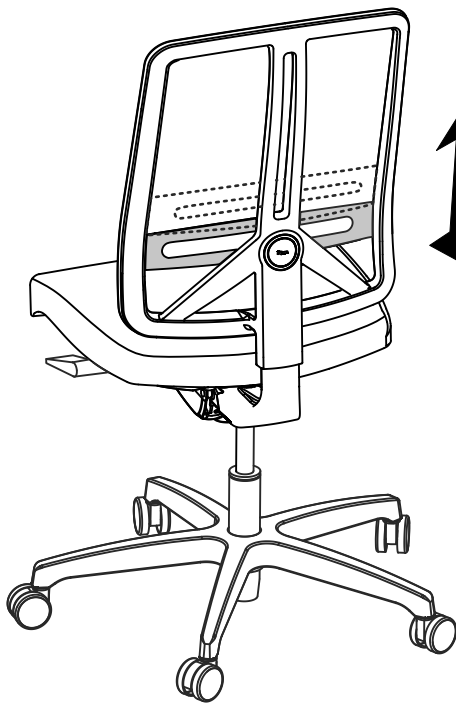

FLEXi FX 1104
NET NT 676A
EASY PRO EP 1204
ADAPT AD 971A

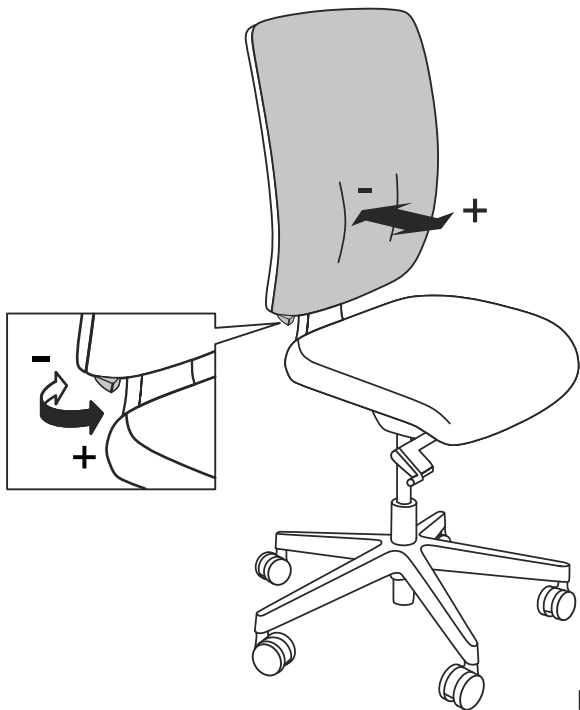

FLEXi FX 1114

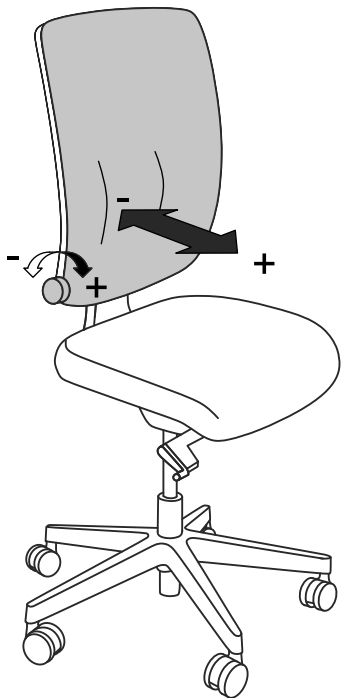

ANATOM AT 985A
ACTIVE AC 954A

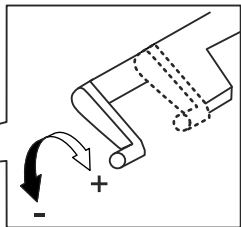
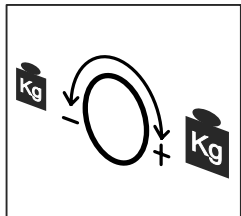
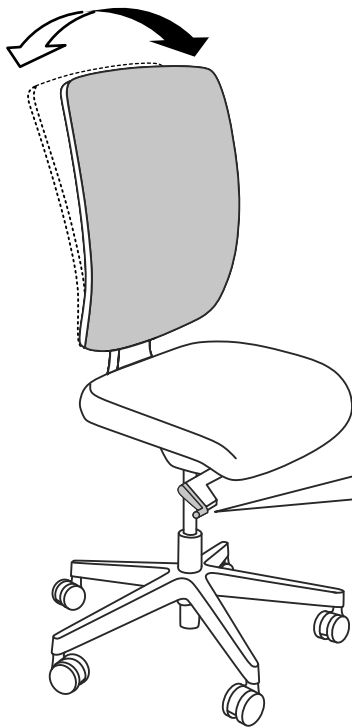

STOP!
STOP!

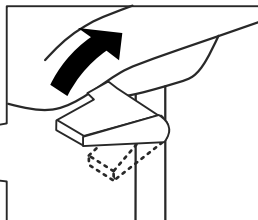
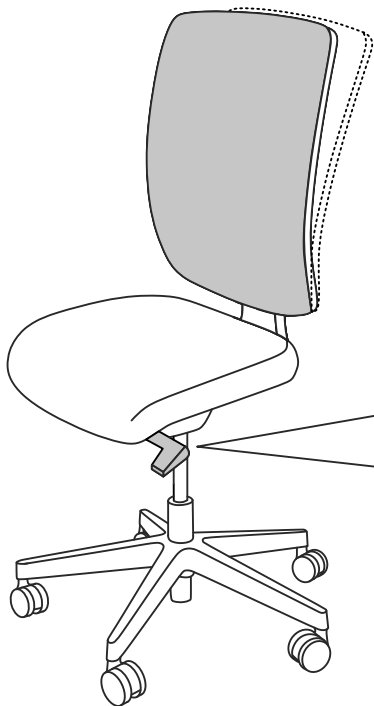

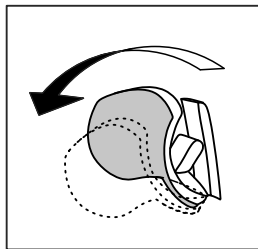
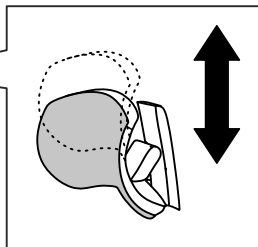
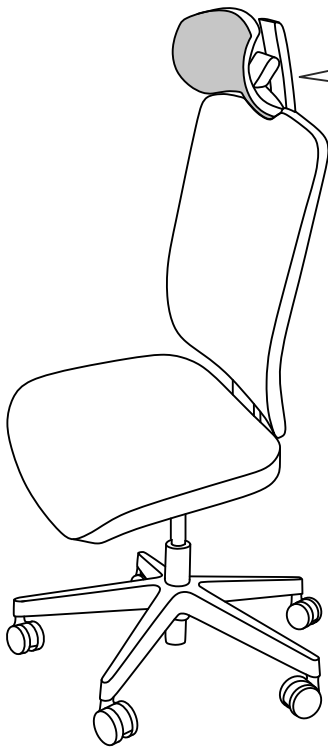

FLEXi FX 1104
FLEXi FX 1114
NET NT 676A

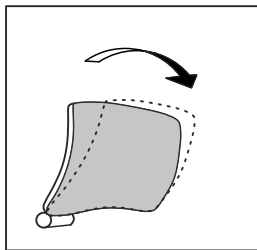
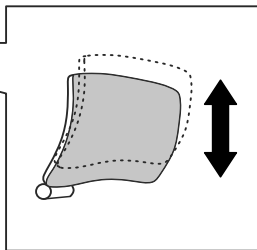
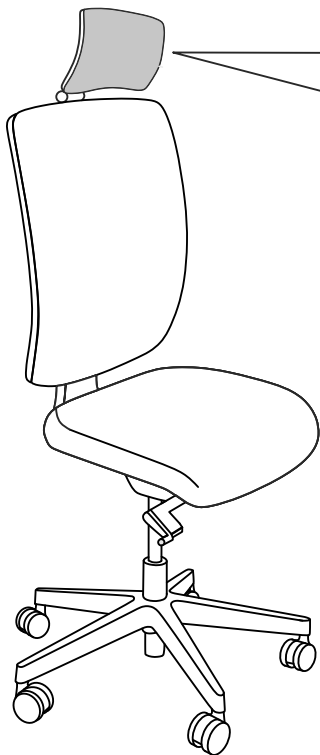

FOCUS FO 642B
ANATOM AT 985A
ACTIVE AC 954A
ADAPT AD 971A

FLEXI FX 1104
FLEXI FX 1114
FOCUS FO 642B
ANATOM AT 985A
NET NT 676A
EASY PRO EP 1204
ADAPT AD 971A

82 1F

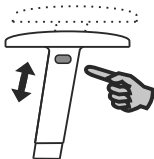

83 3F

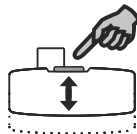
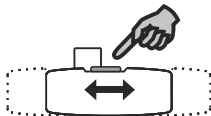
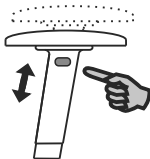

91 1F

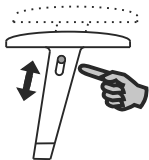

99 2F

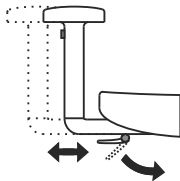
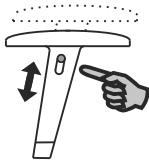

86 3F

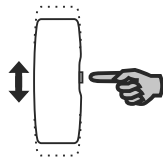
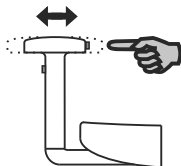
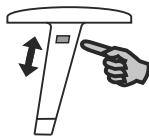

88 4F

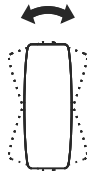
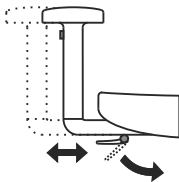
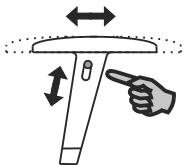

Rim[®]

RIM-CZ spol. s r.o.

Dr. E. Beneše 1015

765 02 Otrokovice

CZECH REPUBLIC

Tel.: +420 577 112 641, -640

Fax: +420 577 101 015

E-mail: info@rim.cz

www.rim.cz

