

k35

k35

La parete vetrata monolitica k35 nasce dalla volontà di creare nuovi modelli di spazio in cui senso estetico ed efficienza si fondono. Duttilità e rapidità di posa sono l'elemento distintivo di questo sistema con profilo a cava singola. Le lastre di vetro verticali, di spessore 10 o 12 mm, sono unite tra loro da giunzioni in policarbonato che assicurano stabilità e tenuta. Un adeguato isolamento acustico è affidato a guarnizioni inserite all'interno del profilo in alluminio estruso.

The monolithic glass partition k35 is conceived to create new models of space, where aesthetic and efficiency coexist. Versatility and fast installation are the distinctive features of this system with a single groove profile. The vertical glasses, available with a thickness of 10 or 12 mm, are connected with polycarbonate joints which ensure stability and keep the glass in place. The gaskets inserted into the aluminum profiles increase the sound dumping properties of the partition wall.

Die monolithische Glastrennwand K35 wurde konzipiert, um neue Raummodelle zu schaffen, wo Ästhetik und Effizienz koexistieren. Vielseitigkeit und schnelle Montage sind die Besonderheiten dieses System mit einzeltem Hohlprofil. Die 10 oder 12 mm Dicke Vertikalgläser sind durch Polycarbonat Befestigungsteile verbunden, die die Stabilität der Gläser gewährleisten.

Die Aluminiumprofilabdichtungen verbessern die akustische Effizienz der Trennwand.

La cloison vitrée monolithique k35 est conçue pour créer de nouveaux modèles d'espace, où esthétique et efficacité coexistent. La polyvalence et l'installation rapide sont les caractéristiques distinctives de ce système avec profil à une seule rainure. Les verres verticaux, disponibles avec une épaisseur de 10 ou 12 mm, sont reliés par des joints en polycarbonate qui assurent la stabilité et maintiennent le verre en place. Les joints insérés dans les profilés en aluminium augmentent les propriétés de décharge sonore de la cloison.

La división de vidrio monolítica k35 está concebida para crear nuevos modelos de espacio, donde la estética y la eficiencia coexisten. La versatilidad y la rápida instalación son las características distintivas de este sistema con perfil con una sola ranura. Las gafas verticales, disponibles con un espesor de 10 o 12 mm, están conectadas con juntas de policarbonato que aseguran la estabilidad y mantienen el vidrio en su lugar. Las juntas insertadas en los perfiles de aluminio aumentan las propiedades de descarga de sonido de la pared divisoria.







MONTANTE ANGOLARE VARIABLE Variable angle junction element
Variable Eckverbindung / Montant angle variable / Montante de conexión con ángulos variables









PORTA BATTENTE

Hinged door / Drehtür / Porte battante / Puerta batiente





200

PORTA BATTENTE CON TELAIO

Framed hinged door / Drehtür mit Rahmen / Porte battante encadrée / Puerta batiente con marco



201



PORTA SCORREVOLE

Sliding door / Schiebetür / Porte coulissante / Puerta corredera





PARETE MONOVETRO

Partition wall with single central glass / Zentral Einzelglaswand / Cloison verre simple central
 Mampara con cristal singulo central

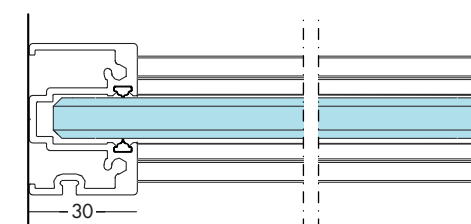
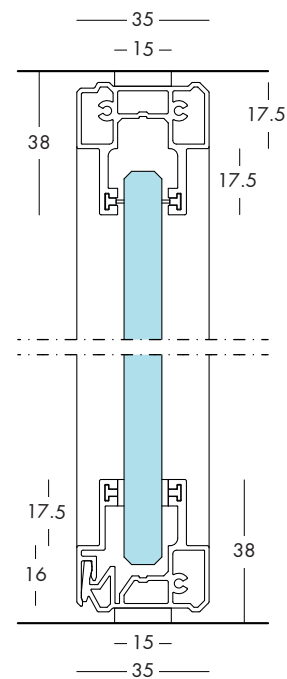

Elemento di partenza da muro FISSO
 Wall starting element - FIXED
 Maueranschlusselement - FIXED
 Profil départ pour fixation au mur - FIXÉ
 Elemento inicial a muro - FIJO

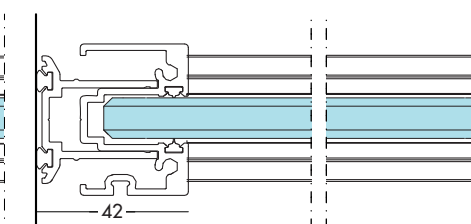

Elemento di partenza da muro TELESCOPICO
 Wall starting element - ADJUSTABLE PROFILE
 Maueranschlusselement - REGULIERBAR PROFIL
 Profil départ pour fixation au mur - PROFIL RÉGLABLE
 Elemento inicial a muro - PERFIL AJUSTABLE

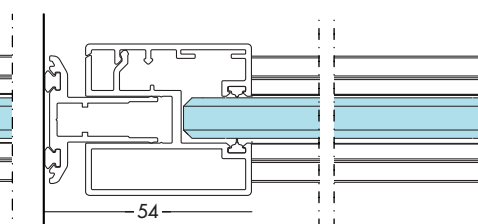

Elemento di partenza da muro REGOLABILE
 Wall starting element - ADJUSTABLE PROFILE
 Maueranschlusselement - REGULIERBAR PROFIL
 Profil départ pour fixation au mur - PROFIL RÉGLABLE
 Elemento inicial a muro - PERFIL AJUSTABLE

GIUNTI DI CONNESSIONE IN POLICARBONATO

Polycarbonate joint / Polykarbonateckverbindung / Jonction en polycarbonate / Perfiles de conexion en polycarbonato

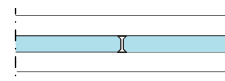
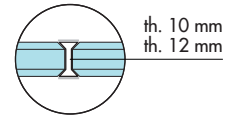

Giunto lineare 2 vie in polycarbonato 180°
2-Ways polycarbonate linear joint 180°
2 Wege Linearverbindung aus Polycarbonat 180°
Jonction linéaire 2 voies en polycarbonate 180°
Perfile de conexion en polycarbonato a 180°

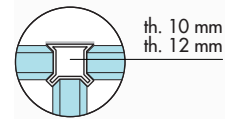
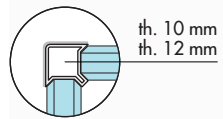

Giunto angolare 2 vie in polycarbonato 90°
2-Ways polycarbonate 90° corner joint
2 Wege Eckverbindung aus Polycarbonat 90°
Jonction angle 2 voies en polycarbonate 90°
Perfile de conexion en polycarbonato a 90°

Giunto angolare 3 vie in polycarbonato 90°
3-Ways polycarbonate 90° corner joint
3 Wege Eckverbindung aus Polycarbonat 90°
Jonction angle 3 voies en polycarbonate 90°
Perfile de conexion en polycarbonato a 3 vías 90°

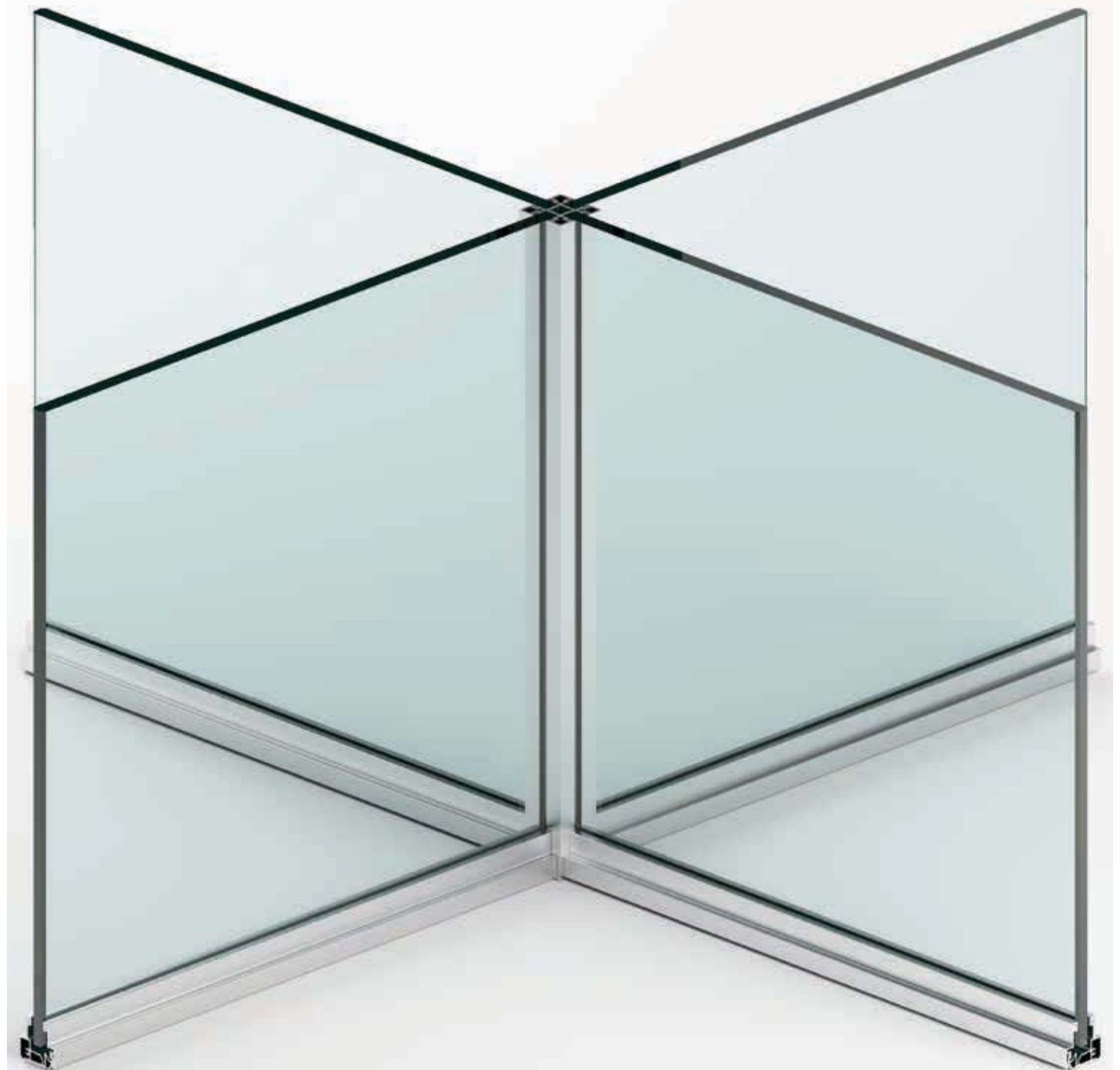
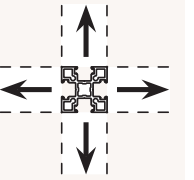

Connessione angolare 4 vie 90°
4-ways corner joint 90°
4 Wege Eckverbindung 90°
Jonction angle 4 voies 90°
Montante a 4 vías 90°

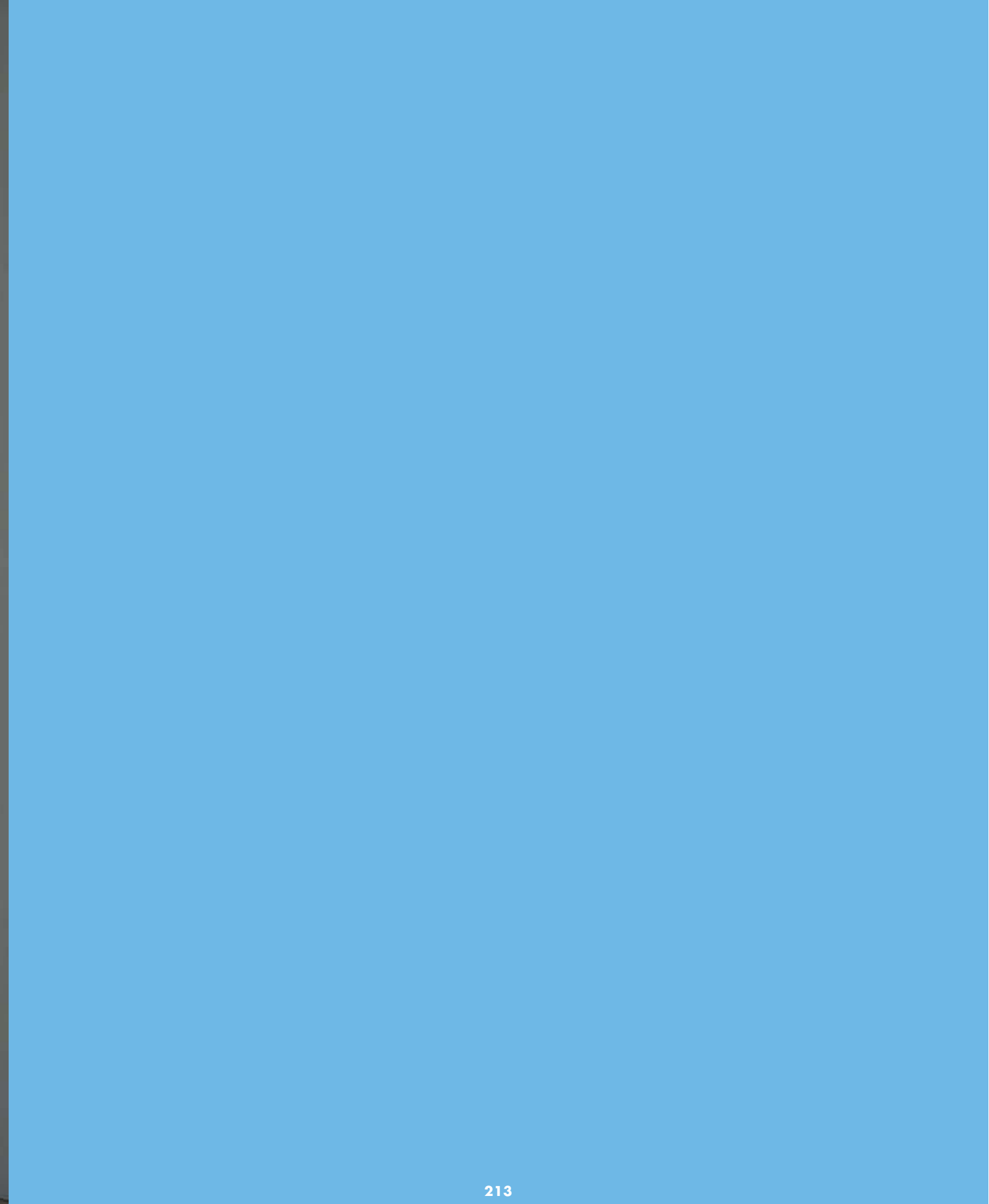

MANIGLIE PORTE BATTENTI

Handles for swing doors / Griffe für Flügeltür / Poignées pour portes battantes / Manijas para puertas batiente



Maniglia per porta battente cieca
Handle for solid hinged door
Griff für Hölztür
Poignée pour porte pleine
Manilla para puerta batiente de madera



Maniglia per porta battente cieca
Handle for solid hinged door
Griff für Hölztür
Poignée pour porte pleine
Manilla para puerta batiente de madera



Maniglia per porta battente cieca
Handle for solid hinged door
Griff für Hölztür
Poignée pour porte pleine
Manilla para puerta batiente de madera

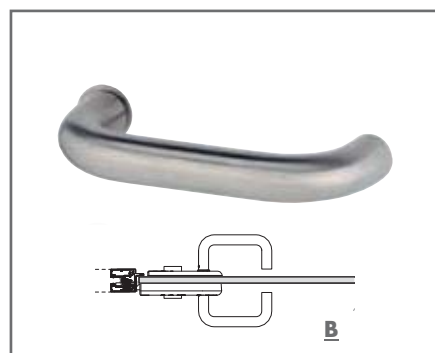

Maniglia porta battente vetro con serratura
Handle for glass hinged door with lock
Griff für Glastür mit Schloss
Poignée pour porte vitrée avec serrure
Manilla para puerta batiente acristalada con cerradura

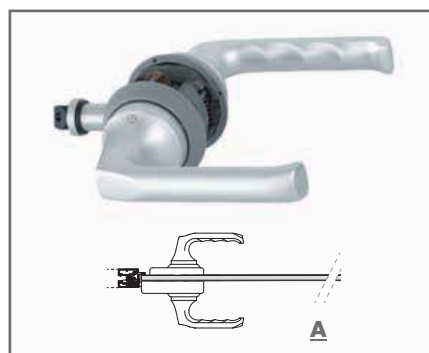

Maniglia porta battente vetro con serratura
Handle for glass hinged door with lock
Griff für Glastür mit Schloss
Poignée pour porte vitrée avec serrure
Manilla para puerta batiente acristalada con cerradura



Maniglia porta battente vetro con serratura
Handle for glass hinged door with lock
Griff für Glastür mit Schloss
Poignée pour porte vitrée avec serrure
Manilla para puerta batiente acristalada con cerradura



Maniglia per porta battente cieca con telaio
Handle for framed hinged door
Griff für tür mit Rahmen
Poignée pour porte encadrée
Manilla para puerta batiente enmarcada



Maniglia per porta battente cieca con telaio
Handle for framed hinged door
Griff für tür mit Rahmen
Poignée pour porte encadrée
Manilla para puerta batiente enmarcada

MANIGLIONI PORTE

Handles for doors / Griffe für Türen / Poignées pour portes / Manijas para puertas



Maniglione
Ladder pull
Griff
Poignée
Manilla