

**DESCRIPTIF TECHNIQUE**

**COLORIS**

**BUREAU, TOP, PLINTHE**

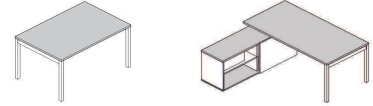

**FAÇADE**

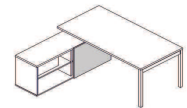

**CORPS - PREMIER GROUPE DE PRIX**

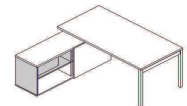
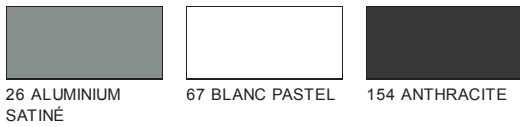

**CORPS - DEUXIEME GROUPE DE PRIX**

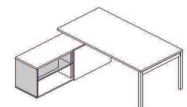

**PIÈTEMENT, - OGI\_N**

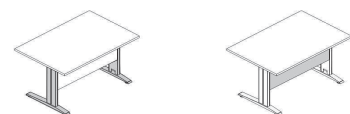
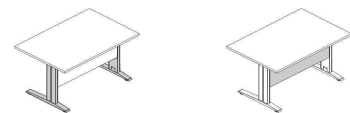
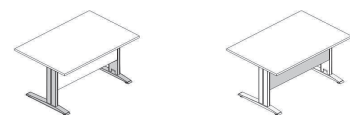
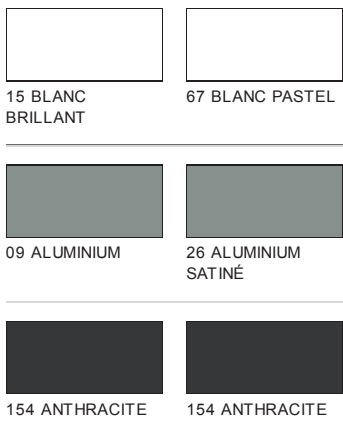

**DESCRIPTIF TECHNIQUE**

**COLORIS**

**VOILES DE FOND STRUCTURELS, - OGI\_V**



09 ALUMINIUM

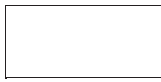

15 BLANC BRILLANT



154 ANTHRACITE

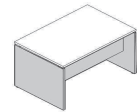

**PIÉTEMENT - OGI\_A, OGI\_Q, OGI\_U, OGI\_Y**



09 ALUMINIUM



15 BLANC BRILLANT



154 ANTHRACITE

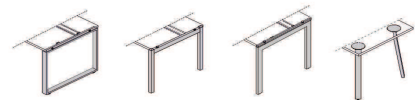

**EXTENSIONS - RETOURS - BUREAU - PLU01, PLY01**



14 HETRE



26 ALUMINIUM SATINÉ

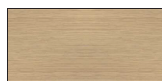

31 CHENE CANADIEN



34 WENGE



39 BOULEAU CLAIR



64 CACAO

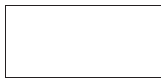

67 BLANC PASTEL



106 NOYER



154 ANTHRACITE

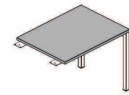
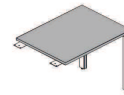

**EXTENSIONS - RETOURS - PIÉTEMENT - PLU01, PLY01**



09 ALUMINIUM

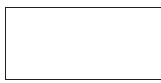

15 BLANC BRILLANT



154 ANTHRACITE

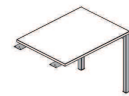
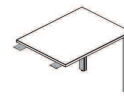

**PASSES CABLES - NOIR**



34 WENGE



64 CACAO



106 NOYER



154 ANTHRACITE

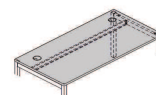

**PASSES CABLES - BUREAU - PLATEAU, PIÉTEMENT, VOILE DE FOND**

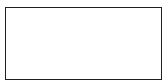

67 BLANC PASTEL

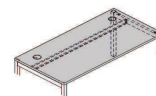

**PASSES CABLES - ALUMINIUM**



14 HETRE



26 ALUMINIUM SATINÉ

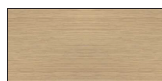

31 CHENE CANADIEN



39 BOULEAU CLAIR

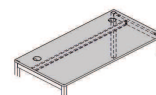

## DESCRIPTIF TECHNIQUE

### PLATEAUX BUREAUX OGI

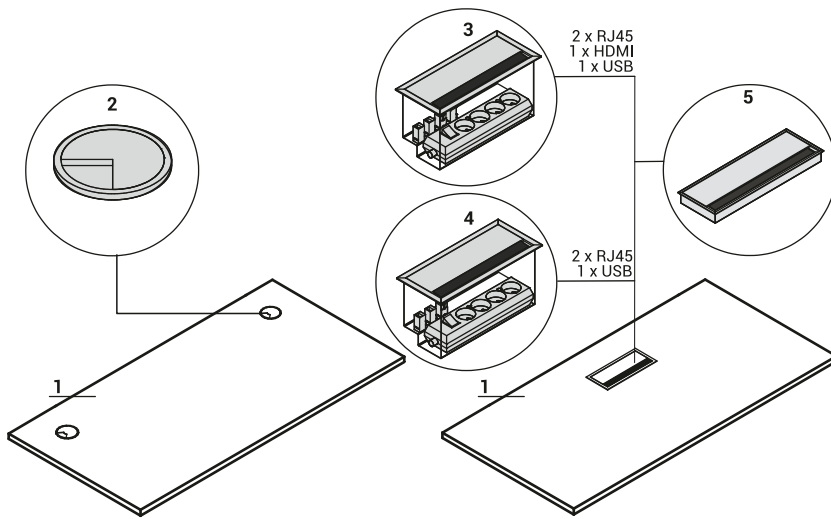

1. **Plateau** - mélaminé 28mm, chants PVC
2. **PLUS VALUE** - 2 x obturateurs 80mm
3. **PLUS VALUE** - Mediabox M04H - 2xRJ45/1xUSB/1xHDMI/4x230V, couleur 09-alu
4. **PLUS VALUE** - Mediabox M04 - 2xRJ45/1xUSB/4x230V, couleur 09-alu
5. **PLUS VALUE** - top access M05 - couleur 09-aluminium

### PLATEAU - CONFIGURATION

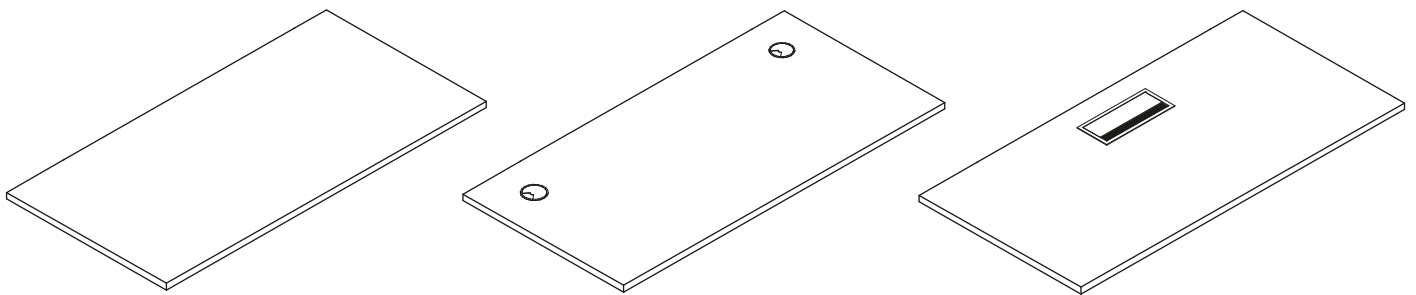

### PIETEMENT

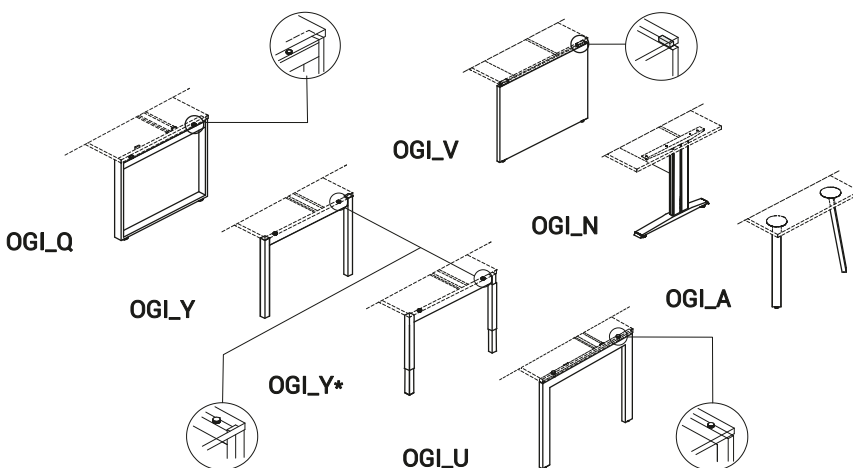

**Ogi Q** - métal peinture poudre, profil 60x20mm, entretoise 15mm

**Ogi Y** - métal peinture poudre, profil 40x40mm, entretoise 10mm

**\*Ogi Y avec réglage en hauteur** - peinture poudre, 2 profils 30x30 et 40x40mm, 50x50 et 60x60mm,

**Ogi U** - métal peinture poudre, profil 60x30mm, entretoise 10mm

**Ogi V** - pied panneau 28 mm, VDF 18mm, entretoise alu 60x20mm entre piétement et plateau

**Ogi N** - métal peinture poudre, colonne 642x149x36mm, pied 647x60mm, électrification verticale, voile de fond structurel - mélaminé 18mm

**Ogi A** - métal peinture poudre, profil 60x30mm

## DESCRIPTIF TECHNIQUE

### RETOURS / EXTENSIONS

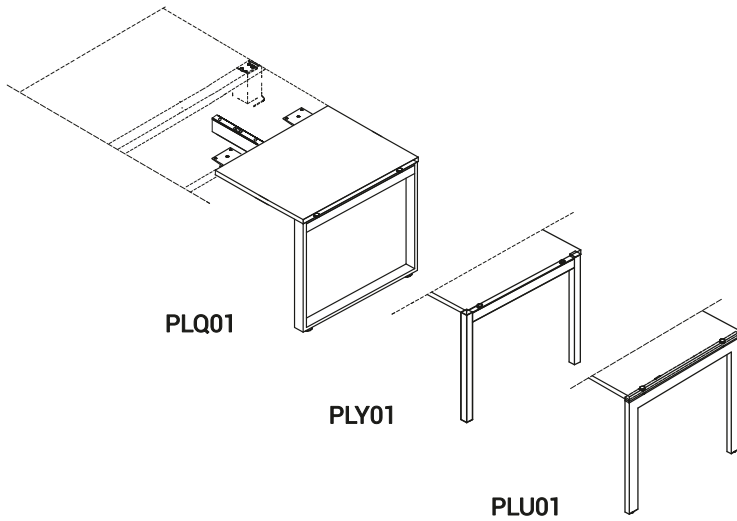

- PLQ01 - retour avec pied OGI Q
- PLU01 - retour avec pied OGI U
- PLY01 - retour avec pied OGI Y

## BUREAUX ET ARMOIRES DE DIRECTION

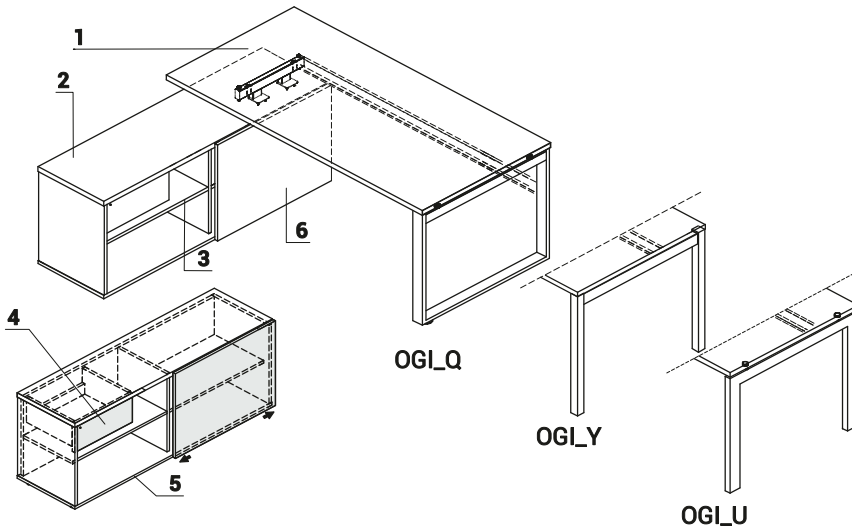

1. Plateau - mélaminé 28mm, chants PVC
2. Top - mélaminé 28mm, chants PVC
3. Tablette - mélaminé 18 mm, chants PVC
4. Tiroir - mélaminé 18mm; chants PVC, serrure, possibilité de changer de place
5. Base - mélaminé 18mm, chants PVC
6. Façade - mélaminé 18 mm, chants PVC

## EXEMPLES DE CONFIGURATIONS

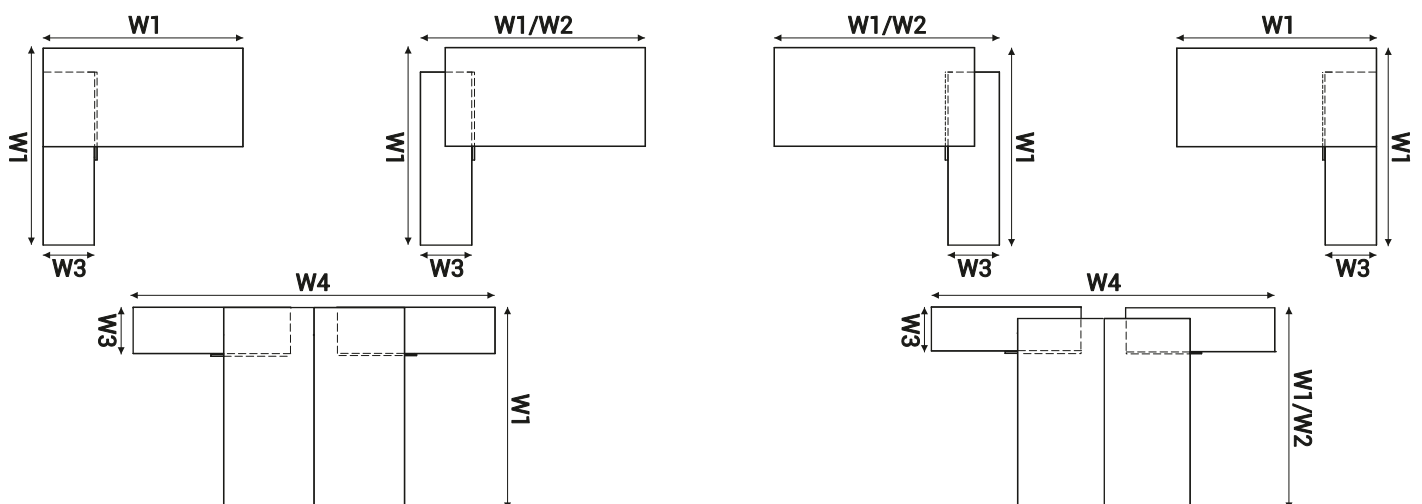

W1 - 1600 | W2 - 1702 | W3 - 432 | W4 - 3218

## DESCRIPTIF TECHNIQUE

### ACCESSOIRES

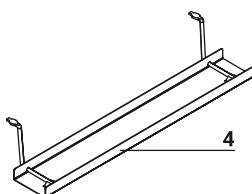
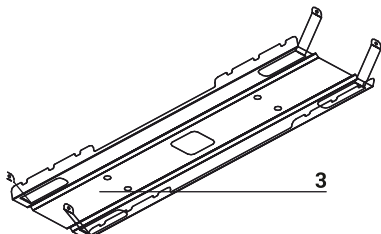
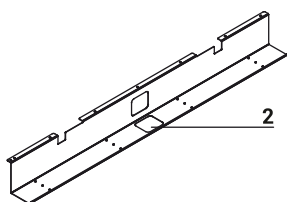
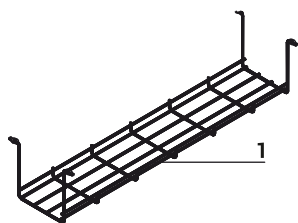

1. **Chemin de câbles S69** - métal peinture poudre, couleur 09-aluminium
2. **Chemin de câbles (SG12, SG16)** - pour bureau individuel, métal peinture poudre, couleur
3. **Chemin de câbles (SG22, SG26)** - pour bureau individuel, métal peinture poudre, couleur
4. **Chemin de câbles E64** - métal peinture poudre, couleur 09-aluminium

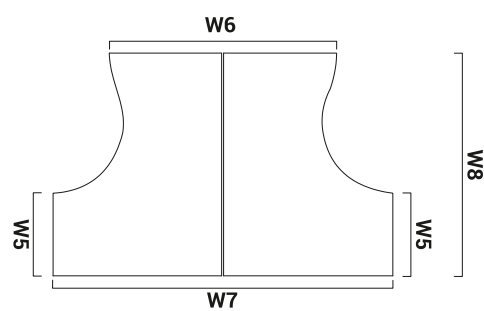
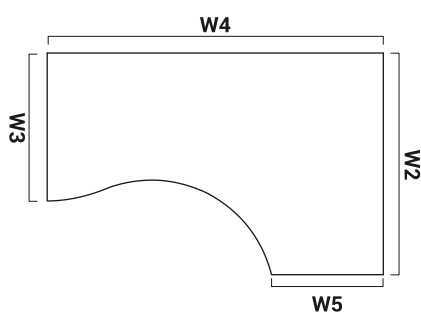
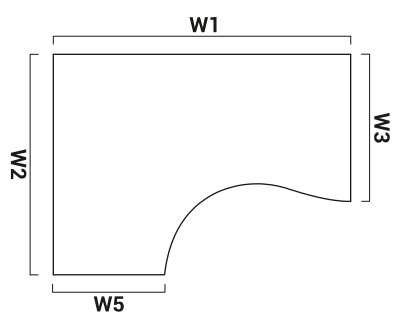

W1 - 1600mm | W2 - 1200mm | W3 - 800mm | W4 - 1800mm | W5 - 600mm | W6 - 1610mm | W7 - 2410mm | W8 - 1600mm

VUE DU PRODUIT	DIMENSIONS [mm]			REF.						REMARQUES
	LONGEUR	PROFONDEUR	HAUTEUR			kg	m3	pcs		

**BUREAUX DROITS**



	1200	600	740	<b>BAG026</b>		25.0	0.035	5		
	1400	600	740	<b>BAG036</b>		24.0	0.039	5		
	1600	600	740	<b>BAG046</b>		26.0	0.043	5		
	1200	700	740	<b>BAG027</b>		24.0	0.039	5		
	1400	700	740	<b>BAG037</b>		27.0	0.044	5		
	1600	700	740	<b>BAG047</b>		29.0	0.049	5		
	1200	800	740	<b>BAG028</b>		26.0	0.043	5		
	1400	800	740	<b>BAG038</b>		29.0	0.049	5		
	1600	800	740	<b>BAG048</b>		32.0	0.055	5		

LÉGENDE:



POIDS NET

VOLUME

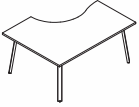

NOMBRE DE COLIS

VUE DU PRODUIT	DIMENSIONS [mm]			REF.						REMARQUES
	LONGEUR	PROFONDEUR	HAUTEUR			kg	m3	pcs		

**BUREAUX COMPACTS**

	1600	1200	740	<b>BAG10</b>		37.0	0.078	5		
	1600	1200	740	<b>BAG11</b>		37.0	0.078	5		
	2343	2029	740	<b>BAG12</b>		93.6	0.198	15		possibilité de fixer les panneaux ZP78P, ZOT78, ZOS78

**BENCHS**

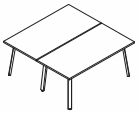
	1600	1210	740	<b>BAG0214</b>		48.0	0.082	8		seulement le rail SG22 possible à installer
	1600	1410	740	<b>BAG0216</b>		54.0	0.094	8		seulement le rail SG22 possible à installer
	1600	1610	740	<b>BAG0218</b>		60.0	0.105	8		seulement le rail SG22 possible à installer

**ELEMENTS A MULTIPLIER LES POSTES**

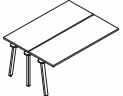
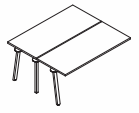
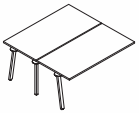
	1600	1210	740	<b>BAG0414</b>		42.0	0.076	5		ped central droit profil 40x40mm
	1600	1410	740	<b>BAG0416</b>		48.0	0.088	5		ped central droit profil 40x40mm
	1600	1610	740	<b>BAG0418</b>		54.0	0.099	5		ped central droit profil 40x40mm

## LÉGENDE:

 POIDS NET

 VOLUME

 NOMBRE DE COLIS

VUE DU PRODUIT	DIMENSIONS [mm]			REF.						REMARQUES
	LONGEUR	PROFONDEUR	HAUTEUR			kg	m3	pcs		

**BUREAUX DROITS**

	1200	600	740	<b>BOQ12</b>		32.0	0.093	4		
	1400	600	740	<b>BOQ14</b>		35.0	0.099	4		
	1600	600	740	<b>BOQ16</b>		38.1	0.104	4		
	1200	800	740	<b>BOQ02</b>		41.0	0.117	3		
	1400	800	740	<b>BOQ03</b>		41.5	0.124	3		
	1600	800	740	<b>BOQ04</b>		42.1	0.131	3		
	1800	800	740	<b>BOQ05</b>		45.2	0.138	3		
	2000	800	740	<b>BOQ06</b>		51.5	0.145	3		

LÉGENDE:

POIDS NET

VOLUME

NOMBRE DE COLIS



VUE DU PRODUIT	DIMENSIONS [mm]			REF.						REMARQUES
	LONGEUR	PROFONDEUR	HAUTEUR			kg	m3	pcs		

**ELEMENTS A MULTIPLIER LES POSTES**

	1200	800	740	<b>BOX42</b>		31.6	0.079	3		
	1400	800	740	<b>BOX43</b>		32.1	0.086	3		
	1600	800	740	<b>BOX44</b>		32.7	0.093	3		
	1800	800	740	<b>BOX45</b>		35.8	0.100	3		

**BUREAUX AVEC ARMOIRE DESSETE**

	1702 1600	1600	740	<b>BOQL20</b>		94.4	0.249	8		universel (droit/gauche)
	1702 1600	3210	740	<b>BOQL40</b>		185.8	0.498	15		
	1800	1600	740	<b>BOQL21</b>		97.5	0.256	8		
	1800	3210	740	<b>BOQL41</b>		192.0	0.511	15		

LÉGENDE:

POIDS NET

VOLUME

NOMBRE DE COLIS

VUE DU PRODUIT	DIMENSIONS [mm]			REF.						REMARQUES
	LONGEUR	PROFONDEUR	HAUTEUR			kg	m3	pcs		

**BENCHS**

	1200	1610	740	<b>BOQ32</b>		61.6	0.235	5		
	1400	1610	740	<b>BOQ33</b>		62.6	0.249	5		
	1600	1610	740	<b>BOQ34</b>		63.8	0.263	5		
	1800	1610	740	<b>BOQ35</b>		70.0	0.276	5		

**ELEMENTS A MULTIPLIER LES POSTES SIMPLES**

	1200	1610	740	<b>BOX62</b>		61.6	0.163	5		
	1400	1610	740	<b>BOX64</b>		62.6	0.177	5		
	1600	1610	740	<b>BOX66</b>		63.8	0.191	5		
	1800	1610	740	<b>BOX68</b>		70.0	0.204	5		

LÉGENDE:

POIDS NET

VOLUME

NOMBRE DE COLIS

VUE DU PRODUIT	DIMENSIONS [mm]			REF.						REMARQUES
	LONGEUR	PROFONDEUR	HAUTEUR			kg	m3	pcs		

**RETOUR POUR BUREAU**

	600	800	740	PLQ01		19.5	0.051	5		
	600	1000	740	PLQ02		20.7	0.056	5		
	600	1200	740	PLQ03		23.2	0.061	5		

LÉGENDE:

POIDS NET

VOLUME

NOMBRE DE COLIS

VUE DU PRODUIT	DIMENSIONS [mm]			REF.						REMARQUES
	LONGEUR	PROFONDEUR	HAUTEUR			kg	m3	pcs		

**BUREAUX DROITS**

	1200	800	740	<b>BNG02</b>		32.6	0.100	3		
	1400	800	740	<b>BNG03</b>		37.0	0.108	3		
	1600	800	740	<b>BNG04</b>		41.9	0.122	3		
	1800	800	740	<b>BNG05</b>		45.3	0.124	3		

**BUREAUX COMPACTS**

	1600	1200	740	<b>BNG10</b>		45.9	0.145	3		utiliser le pied de soutien approprié
	1600	1200	740	<b>BNG11</b>		45.9	0.145	3		utiliser le pied de soutien approprié
	1800	1200	740	<b>BNG17</b>		52.9	0.149	3		utiliser le pied de soutien approprié
	1800	1200	740	<b>BNG18</b>		52.9	0.149	3		utiliser le pied de soutien approprié

LÉGENDE:

POIDS NET

VOLUME

NOMBRE DE COLIS

VUE DU PRODUIT	DIMENSIONS [mm]			REF.						REMARQUES
	LONGEUR	PROFONDEUR	HAUTEUR			kg	m3	pcs		

**BUREAUX DROITS**

	1200	600	740	<b>BOU12</b>		29.8	0.067	4		
	1400	600	740	<b>BOU14</b>		32.8	0.072	4		
	1600	600	740	<b>BOU16</b>		35.9	0.078	4		
	1200	800	740	<b>BOU19</b>		37.8	0.069	3		
	1400	800	740	<b>BOU20</b>		38.3	0.076	3		
	1600	800	740	<b>BOU21</b>		38.9	0.083	3		
	1800	800	740	<b>BOU22</b>		42.0	0.090	3		
	2000	800	740	<b>BOU27</b>		48.3	0.097	3		

LÉGENDE:

POIDS NET

VOLUME

NOMBRE DE COLIS

VUE DU PRODUIT	DIMENSIONS [mm]			REF.						REMARQUES
	LONGEUR	PROFONDEUR	HAUTEUR			kg	m3	pcs		

**ELEMENTS A MULTIPLIER LES POSTES SIMPLES**

	1200	800	740	<b>BOX42</b>		31.6	0.079	3		
	1400	800	740	<b>BOX43</b>		32.1	0.086	3		
	1600	800	740	<b>BOX44</b>		32.7	0.093	3		
	1800	800	740	<b>BOX45</b>		35.8	0.100	3		

**BUREAUX COMPACTS**

	1600	1200	740	<b>BOU23</b>		44.1	0.109	3		
	1600	1200	740	<b>BOU24</b>		46.1	0.109	3		
	1800	1200	740	<b>BOU25</b>		42.0	0.119	3		
	1800	1200	740	<b>BOU26</b>		44.0	0.119	3		
	1600	2410	740	<b>BOU15</b>		83.5	0.216	5		

LÉGENDE:

POIDS NET

VOLUME

NOMBRE DE COLIS

VUE DU PRODUIT	DIMENSIONS [mm]			REF.						REMARQUES
	LONGEUR	PROFONDEUR	HAUTEUR			kg	m3	pcs		

**BUREAUX AVEC ARMOIRE DESSESTE**

	1702 1600	1600	740	<b>BOUL20</b>		92.9	0.231	8		universel (droit/gauche)
	1702 1600	3210	740	<b>BOUL40</b>		182.6	0.463	15		
	1800	1600	740	<b>BOUL21</b>		96.0	0.238	8		
	1800	3210	740	<b>BOUL41</b>		188.8	0.476	15		

**BENCHS**

	1200	1610	740	<b>BOU32</b>		68.9	0.137	5		
	1400	1610	740	<b>BOU33</b>		69.9	0.151	5		
	1600	1610	740	<b>BOU34</b>		71.1	0.165	5		
	1800	1610	740	<b>BOU35</b>		77.3	0.178	5		

LÉGENDE:

POIDS NET

VOLUME

NOMBRE DE COLIS

VUE DU PRODUIT	DIMENSIONS [mm]			REF.						REMARQUES
	LONGEUR	PROFONDEUR	HAUTEUR			kg	m3	pcs		

**ELEMENTS A MULTIPLIER LES POSTES**

	1200	1610	740	<b>BOX62</b>		61.6	0.163	5		
	1400	1610	740	<b>BOX64</b>		62.6	0.177	5		
	1600	1610	740	<b>BOX66</b>		63.8	0.191	5		
	1800	1610	740	<b>BOX68</b>		70.0	0.204	5		

**RETOUR POUR BUREAU**

	600	800	740	<b>PLU01</b>		18.4	0.038	5		
	600	1000	740	<b>PLU02</b>		19.6	0.043	5		
	600	1200	740	<b>PLU03</b>		22.1	0.048	5		

LÉGENDE:

POIDS NET

VOLUME

NOMBRE DE COLIS



VUE DU PRODUIT	DIMENSIONS [mm]			REF.						REMARQUES
	LONGEUR	PROFONDEUR	HAUTEUR			kg	m3	pcs		

**BUREAUX DROITS**

	1200	600	740	<b>BOY12</b>		30.4	0.076	4		
	1400	600	740	<b>BOY14</b>		33.4	0.081	4		
	1600	600	740	<b>BOY16</b>		36.5	0.087	4		
	1200	700	740	<b>BOY22</b>		30.9	0.066	3		
	1400	700	740	<b>BOY24</b>		34.3	0.072	3		
	1600	700	740	<b>BOY26</b>		37.9	0.079	3		
	1200	800	740	<b>BOY02</b>		37.3	0.075	3		
	1400	800	740	<b>BOY03</b>		37.8	0.082	3		
	1600	800	740	<b>BOY04</b>		38.4	0.089	3		

LÉGENDE:

POIDS NET

VOLUME

NOMBRE DE COLIS

VUE DU PRODUIT	DIMENSIONS [mm]			REF.						REMARQUES
	LONGEUR	PROFONDEUR	HAUTEUR			kg	m3	pcs		

**BUREAUX DROITS**

	1800	800	740	<b>BOY05</b>		41.5	0.096	3		
	2000	800	740	<b>BOY06</b>		47.8	0.103	3		

**ELEMENTS A MULTIPLIER LES POSTES SIMPLES**

	1200	700	740	<b>BOX32</b>		26.4	0.068	3		
	1400	700	740	<b>BOX34</b>		29.8	0.075	3		
	1600	700	740	<b>BOX36</b>		33.4	0.081	3		
	1200	800	740	<b>BOX42</b>		31.6	0.079	3		
	1400	800	740	<b>BOX43</b>		32.1	0.086	3		
	1600	800	740	<b>BOX44</b>		32.7	0.093	3		
	1800	800	740	<b>BOX45</b>		35.8	0.100	3		

LÉGENDE:

POIDS NET

VOLUME

NOMBRE DE COLIS

VUE DU PRODUIT	DIMENSIONS [mm]			REF.						REMARQUES
	LONGEUR	PROFONDEUR	HAUTEUR			kg	m3	pcs		

**BUREAUX COMPACTS**

	1600	1200	740	<b>BOY10</b>		43.6	0.115	3		
	1600	1200	740	<b>BOY11</b>		45.6	0.115	3		
	1800	1200	740	<b>BOY17</b>		41.5	0.124	3		
	1800	1200	740	<b>BOY18</b>		43.5	0.124	3		
	1600	2410	740	<b>BOY15</b>		82.9	0.228	5		

**BUREAUX AVEC ARMOIRE DESSERTE**

	1702 1600	1600	740	<b>BOYL20</b>		92.5	0.237	8		universel (droit/gauche)
	1702 1600	3210	740	<b>BOYL40</b>		181.9	0.475	15		
	1800	1600	740	<b>BOYL21</b>		95.6	0.244	8		
	1800	3210	740	<b>BOYL41</b>		188.1	0.488	15		

PLUS VALUE

LÉGENDE:

POIDS NET

VOLUME

NOMBRE DE COLIS

VUE DU PRODUIT	DIMENSIONS [mm]			REF.						REMARQUES
	LONGEUR	PROFONDEUR	HAUTEUR			kg	m3	pcs		

**BUREAUX AVEC REGLAGE EN HAUTEUR MANUELLE**

	1200	800	640 860	<b>BOY02R</b>		39.6	0.075	3		réglage en hauteur manuel de 640 à 860mm, par paliers de 20mm
	1400	800	640 860	<b>BOY03R</b>		40.1	0.082	3		réglage en hauteur manuel de 640 à 860mm, par paliers de 20mm
	1600	800	640 860	<b>BOY04R</b>		40.7	0.089	3		réglage en hauteur manuel de 640 à 860mm, par paliers de 20mm
	1800	800	640 860	<b>BOY05R</b>		43.8	0.096	3		réglage en hauteur manuel de 640 à 860mm, par paliers de 20mm
	2000	800	640	<b>BOY06R</b>		50.1	0.103	3		réglage en hauteur manuel de 640 à 860mm, par paliers de 20mm

LÉGENDE:

POIDS NET

VOLUME

NOMBRE DE COLIS

VUE DU PRODUIT	DIMENSIONS [mm]			REF.						REMARQUES
	LONGEUR	PROFONDEUR	HAUTEUR			kg	m3	pcs		

**BENCHS**

	1200	1410	740	<b>BOY42</b>		55.8	0.131	5		
	1400	1410	740	<b>BOY44</b>		62.6	0.143	5		
	1600	1410	740	<b>BOY46</b>		69.8	0.156	5		
	1200	1610	740	<b>BOY32</b>		68.3	0.149	5		
	1400	1610	740	<b>BOY33</b>		69.3	0.163	5		
	1600	1610	740	<b>BOY34</b>		70.5	0.176	5		
	1800	1610	740	<b>BOY35</b>		76.7	0.190	5		

LÉGENDE:

POIDS NET

VOLUME

NOMBRE DE COLIS

VUE DU PRODUIT	DIMENSIONS [mm]			REF.						REMARQUES
	LONGEUR	PROFONDEUR	HAUTEUR			kg	m3	pcs		

**ELEMENTS A MULTIPLIER LES POSTES**

	1200	1410	740	<b>BOX52</b>		49.8	0.137	5		
	1400	1410	740	<b>BOX54</b>		56.6	0.150	5		
	1600	1410	740	<b>BOX56</b>		63.8	0.162	5		
	1200	1610	740	<b>BOX62</b>		61.6	0.163	5		
	1400	1610	740	<b>BOX64</b>		62.6	0.177	5		
	1600	1610	740	<b>BOX66</b>		63.8	0.191	5		
	1800	1610	740	<b>BOX68</b>		70.0	0.204	5		

LÉGENDE:

POIDS NET

VOLUME

NOMBRE DE COLIS

VUE DU PRODUIT	DIMENSIONS [mm]			REF.						REMARQUES
	LONGEUR	PROFONDEUR	HAUTEUR			kg	m3	pcs		

**RETOUR POUR BUREAU**

	600	800	740	<b>PLY01</b>		18.7	0.042	5		
	600	1000	740	<b>PLY02</b>		19.9	0.047	5		
	600	1200	740	<b>PLY03</b>		22.4	0.052	5		

LÉGENDE:

POIDS NET

VOLUME

NOMBRE DE COLIS

VUE DU PRODUIT	DIMENSIONS [mm]			REF.						REMARQUES
	LONGEUR	PROFONDEUR	HAUTEUR			kg	m3	pcs		

**BUREAUX DROITS**

	1200	800	740	<b>BVG02</b>		45.3	0.096	3		
	1400	800	740	<b>BVG03</b>		49.6	0.104	3		
	1600	800	740	<b>BVG04</b>		53.5	0.113	3		
	1800	800	740	<b>BVG05</b>		57.9	0.120	3		

**BUREAUX COMPACTS**

	1600	1200	740	<b>BVG10</b>		57.5	0.135	3		
	1600	1200	740	<b>BVG11</b>		57.5	0.135	3		
	1800	1200	740	<b>BVG17</b>		65.5	0.145	3		
	1800	1200	740	<b>BVG18</b>		65.5	0.145	3		

LÉGENDE:

POIDS NET

VOLUME

NOMBRE DE COLIS



VUE DU PRODUIT	DIMENSIONS [mm]			REF.						REMARQUES
	LONGEUR	PROFONDEUR	HAUTEUR			kg	m3	pcs		
	1050	107	120	<b>SG12</b>		2.0	0.018	1		pour bureaux simples L1200 et 1400mm
	1450	107	120	<b>SG16</b>		3.0	0.025	1		pour bureaux simples L1600 et 1800mm
	1050	361	130	<b>SG22</b>		2.0	0.072	1		pour banchs en 1200 et 1400 et banchs OGI A
	1450	361	130	<b>SG26</b>		2.0	0.099	1		pour banchs en 1600 et 1800 sauf banchs OGI A
	80	80	23	<b>PK80</b>		0.1	0.000	1		passer-câble Ø 80mm, couleur 02-gris,08-noir,67-blanc
	275	120	140	<b>M04</b>		0.0	0.001	0		4x230V, 2xRJ45, 1xUSB
	275	120	140	<b>M04H</b>		0.0	0.001	0		4x230V, 2xRJ45, 1xUSB, 1xHDMI
	275	120	25	<b>M05</b>		0.3	0.002	1		TOP ACCESS
	460	110	121	<b>E64</b>		1.0	0.006	0		bac à câble - 09 aluminium

LÉGENDE:

POIDS NET

VOLUME

NOMBRE DE COLIS



VUE DU PRODUIT	DIMENSIONS [mm]			REF.						REMARQUES
	LONGEUR	PROFONDEUR	HAUTEUR			kg	m3	pcs		
	580	162	123	<b>S69</b>		1.0	0.015	1		09 - aluminium
	140	140	750	<b>S94</b>		1.0	0.004	1		ressort passe-câbles, couleur 09-aluminium
	470	42	34	<b>S95</b>		1.0	0.001	1		Organisateur de câbles vertical pour bureau OGI Y et pied droit central OGI A, profil 40mm
	470	62	34	<b>S93</b>		1.0	0.002	1		chemin de câbles verticale, pour bureau DRIVE, YAN, OGI A, OGI Q, OGI U, profil largeur 60mm
	140	70	750	<b>S81</b>		1.1	0.008	1		vertèbre passe-câbles couleur 09-aluminium
	1000	70	35	<b>S82</b>		1.0	0.005	1		passe-câbles à fixer en-dessous du plan de travail
				<b>AK3</b>		0.2	0.000	1		velcro gris 6 pcs (3 avec vis, 3 sans vis)
				<b>AK5</b>		0.2	0.000	1		clip de gestion de câbles 5 pcs
	212	460	617	<b>S83</b>		2.6	0.027	1		support UC vertical, couleur: 09-aluminium, 15 - métal blanc brillant, 154 - anthracite

**LÉGENDE:**

POIDS NET

VOLUME

NOMBRE DE COLIS

VUE DU PRODUIT	DIMENSIONS [mm]			REF.						REMARQUES
	LONGEUR	PROFONDEUR	HAUTEUR			kg	m3	pcs		

## ACCESSOIRES

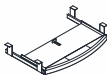
	220	470	148	<b>S73</b>		3.2	0.002	1		support sur roulettes pour UC, couleur 26 - aluminum satiné
	610	400	85	<b>C01</b>		0.5	0.010	1		tablette pour clavier profondeur 800 mm, 02-gris

LÉGENDE:

 POIDS NET

 VOLUME

 NOMBRE DE COLIS

