

Lintex 2018



About us

With a vision to simplify communication in modern office and educational environments, we have developed into one of the leading European brands within writable surfaces. Whiteboards and glass boards has later been joined by noticeboards, office screens and sound absorbers. All our products are developed, produced and sold under our own brand.

Lintex is a family owned business, established in 1983. Our head office and production is located in Småland, Sweden, with local subsidiary companies, sales offices and agents in Scandinavia and all over Europe.

Environment

We are committed to minimizing our environmental footprint. This applies to the materials we use in our products, production methods and energy consumption. An important part of our environmental commitment is to certify our products. We work close together with Möbelfakta and SundaHus. We are also ISO14001 certified.



Writing Boards - Whiteboard

Air whiteboard	7
Air Spaces whiteboard	8
Air Textile noticeboard	9
Wood whiteboard	10
Note whiteboard	11
Air Lines whiteboard	12
Air Flow whiteboard	13
Air TV whiteboard	14
ONE whiteboard	15
Edge whiteboard	16
Acoustic Board sound absorbing whiteboard	17
Boarder whiteboard	18
Boarder Sharp whiteboard	19
Boarder 1530 whiteboard	19

Writing Boards – Glass

Mood Wall glass board	24
Flow Wall glass board	26
Mood Fabric Wall	28
Bloc	30

Writing Board Accessories

Mood Box	34
Mood Pocket	35
Air Pocket	35
Accessory kit Black	36
Bowl toolbox	37
Startset Birch & Cork	38
Pens & penholders	38
Board eraser & felt sets	38
Magnets	38
Pen Tray Air whiteboard & Mood glass board	39

Conference Cabinets

Mood Conference whiteboard	42
Mood Conference TV	43

Mobile Writing Boards & Flipchart Easels

Mood Fabric Mobile	46
Wood mobile whiteboard	48
Mono mobile glass board	50
Mood Mobile & Flow Mobile	52
M3 mobile double-sided whiteboard	54
ONE flip chart easel	56
ONE mobile flip chart easel	57
ONE mobile whiteboard	58
ONE mobile double-sided whiteboard	59

Office Screens

Edge floor screen	62
Edge table screen	63
Mood Fabric Table	68
ONE Screen	70

Notice Boards & Sound Absorbers

Edge Wall sound absorber	74
Bloc sound absorber	76
Bloc noticeboard	78
Air Cork noticeboard	79
Air Bulletin noticeboard	80
Textile notice board	82
Boarder Bulletin noticeboard	83
Boarder Textile noticeboard	84
Boarder linen/cork	85

Colour Charts

Blazer Lite	86
Fiji	87
Cara	88
Xpress	89
Bulletin Board	90
Mood	91

Other

Sales and delivery terms	92
Contact	93
Agents	94



Writing Boards - Whiteboard



Air whiteboard

Ceramic steel writing board with bevelled white edges instead of a traditional frame. This gives the board a sense of floating on the wall. Can also be supplemented by a textile noticeboards (see Air Textile).

Concealed fittings
 Depth from wall 16 mm
 Magnetic ceramic steel writing surface
 e3 certified 99% recyclable
 30-year warranty on the writing surface



Our whiteboards

Our ceramic steel whiteboards are of the very highest quality and come with a 30-year warranty on the writing surface. The steel sheet core is made of 50% recycled material and the boards are up to 99% recyclable. All boards are individually packaged and include fittings for wall mounting.

When ordering chalkboards or whiteboards in other colours than white (NCS S 1002 G50Y), please add one of the following prefixes in front of the article number:

- BE = beige (whiteboard), NCS S 1005 Y20R
- G = green (chalkboard), NCS S 7010 G10Y
- GG = graphite grey (chalkboard), NCS S 7500 N
- B = blue (chalkboard), NCS S 5040 R80B
- GR = light grey (whiteboard) NCS S 2000N
- S = black (chalkboard), NCS S 8500 N

For matte or semi-matte surface, please add one of the following prefixes to the article number:

- S = Semi-matte
- M = Matte

Since writing is difficult to erase on a matte surface, we don't recommend matte surface as a writing board.

Article number	Name	Size w x h mm	Weight kg
27826AIR	Air Whiteboard	990 x 1190	17
27827AIR	Air Whiteboard	1490 x 1190	25
27828AIR	Air Whiteboard	1990 x 1190	34
27829AIR	Air Whiteboard	2490 x 1190	39
27830AIR	Air Whiteboard	2990 x 1190	45

Accessories			
Article number	Name	Size w x h mm	Weight kg
40205-S	Air Pocket Black aluminium	160 x 200	
40205-V	Air Pocket White aluminium	160 x 200	
1215T	Pen tray, plexi, transparent	200	
1215S	Pen tray, plexi, black	200	
1215V	Pen tray, plexi, white	200	
1216T	Pen tray, plexi, transparent	500	
1216S	Pen tray, plexi, black	500	
1216V	Pen tray, plexi, white	500	
1218-B	Pen tray, birch	200	

All accessories see page 33

Air Spaces whiteboard

Air Spaces are made by connecting Air whiteboards to each other, creating large continuous writing spaces. Concealed fittings give the surface subtle joints, measuring less than 1 mm. The continuous whiteboard can also be supplemented by textile modules (see Air Textile).

Concealed fittings and subtle joints
Depth from wall 16 mm
Magnetic ceramic steel writing surface
e3 certified 99% recyclable
30-year warranty on the writing surface



Article number	Name	Size w x h mm	Weight kg
27828AIRZ-2	Air Whiteboard, 2 boards	2380 x 1990	67
27828AIRZ-3	Air Whiteboard, 3 boards	3570 x 1990	101
27828AIRZ-4	Air Whiteboard, 4 boards	4760 x 1990	134
27828AIRZ-5	Air Whiteboard, 5 boards	5950 x 1990	168
27829AIRZ-2	Air Whiteboard, 2 boards	2380 x 2490	90
27829AIRZ-3	Air Whiteboard, 3 boards	3570 x 2490	135
27829AIRZ-4	Air Whiteboard, 4 boards	4760 x 2490	180
27829AIRZ-5	Air Whiteboard, 5 boards	5950 x 2490	225
27830AIRZ-2	Air Whiteboard, 2 boards	2380 x 2990	90
27830AIRZ-3	Air Whiteboard, 3 boards	3570 x 2990	135
27830AIRZ-4	Air Whiteboard, 4 boards	4760 x 2990	180
27830AIRZ-5	Air Whiteboard, 5 boards	5950 x 2990	225

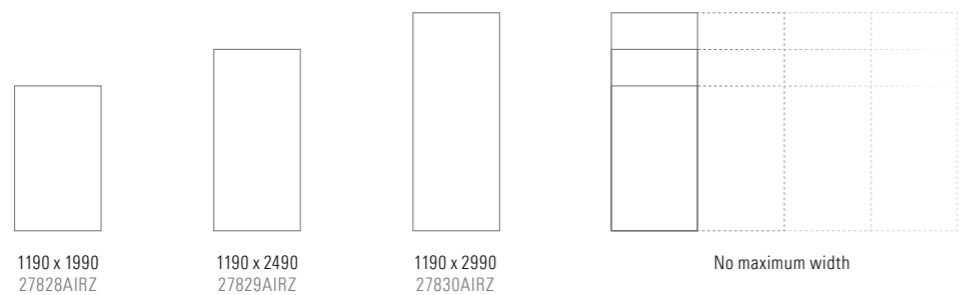

Air Textile noticeboard

A textile noticeboard made to supplement Air whiteboard and Air spaces. The modules can be mounted on either side of an Air whiteboard or in between boards in Air Spaces. Available in 12 standard colours Blazer lite, but can also be had with Kvadrat Remix or Canvas.

Concealed fittings
Depth from wall 16 mm
Price group B, Blazer Lite
Price group C, Kvadrat Canvas & Remix
Supplements Air whiteboard & Air Spaces

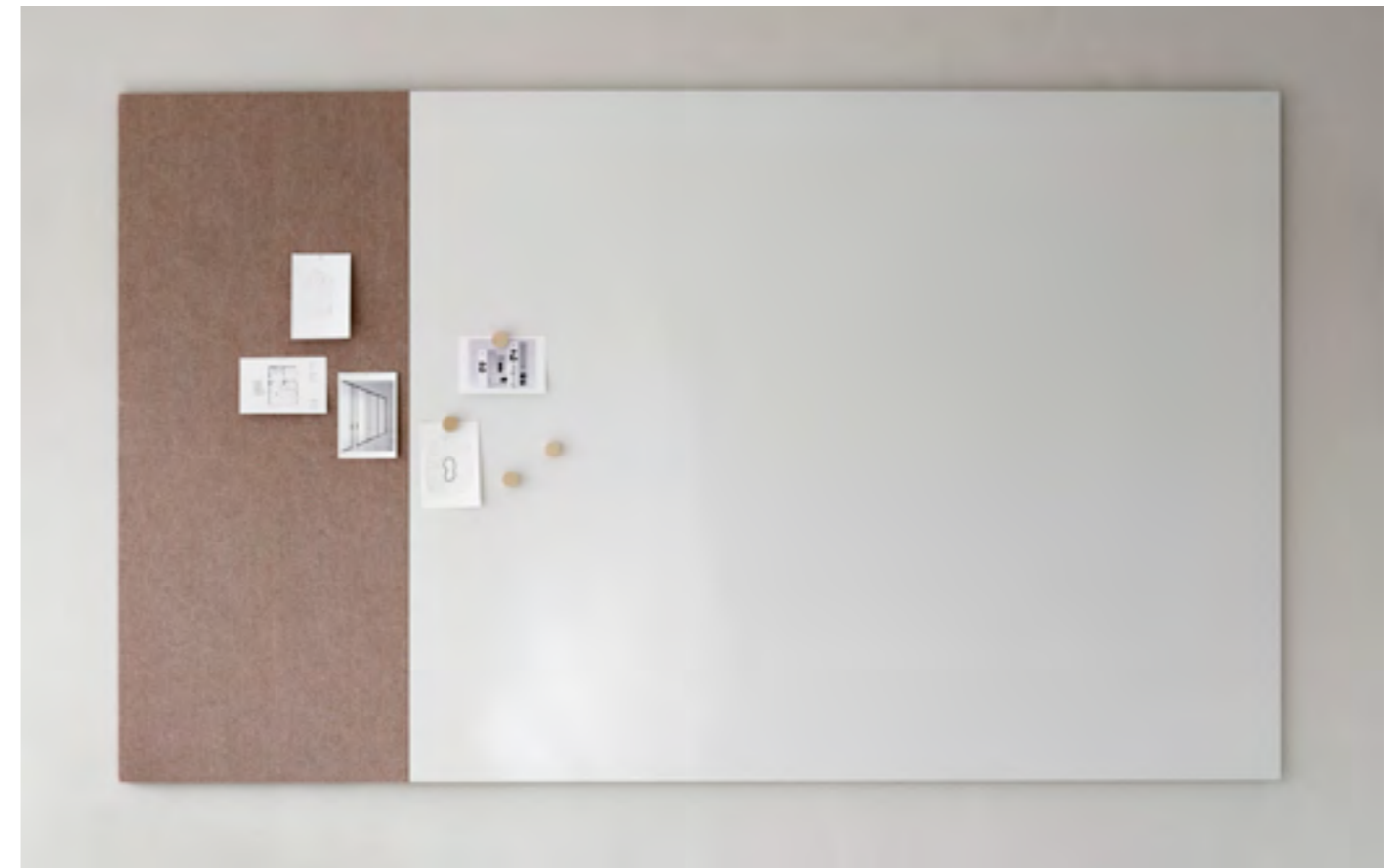

Article number	Name	Size w x h mm	Weight kg
20210MA-textile	Air Textile Module	250 x 1190	2
20510MA-textile	Air Textile Module	500 x 1190	4
20220MA-textile	Air Textile Module	250 x 1990	4
20520MA-textile	Air Textile Module	500 x 1990	7
20230MA-textile	Air Textile Module	250 x 2490	5
20530MA-textile	Air Textile Module	500 x 2490	8
20240MA-textile	Air Textile Module	250 x 2990	6
20540MA-textile	Air Textile Module	500 x 2990	10

Colour chart on page 86

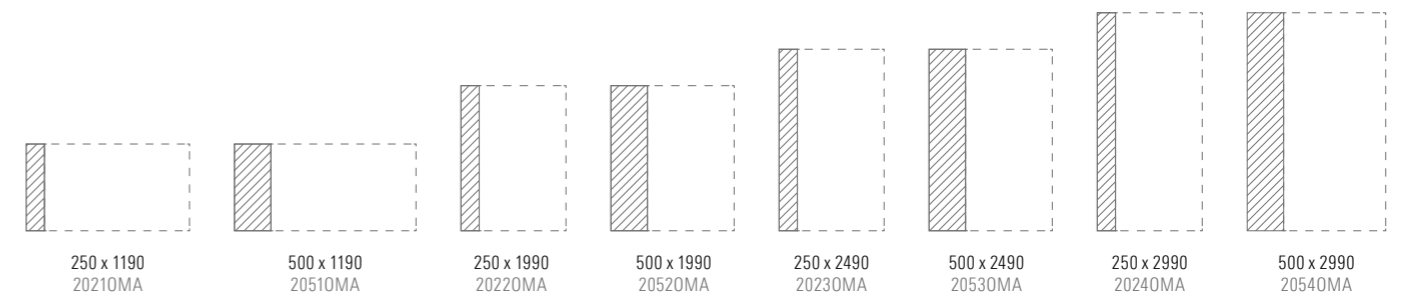

Wood whiteboard

This whiteboard has a frame crafted from solid oak and a contrasting crisp white enameled steel writing surface. Sharp lines and carefully mitered corners makes this wall piece a sophisticated addition to any professional space.

Design Christian Halleröd

Concealed fittings
 Depth from wall 20 mm
 Magnetic ceramic steel writing surface
 e3 certified 99% recyclable
 30-year warranty on the writing surface



Article number	Name		Size w x h mm	Weight kg
81126	Wood Wall	New	1008 x 1208	16
81127	Wood Wall	New	1508 x 1208	23
81128	Wood Wall	New	2008 x 1208	31

Note whiteboard

A writing board that is both mobile and fixed. The board is double sided, with two magnetic ceramic steel surfaces. Note is manufactured with a lightweight core that makes it light enough to carry around. It can easily be hung using the included bracket or used leaning against a wall for spontaneous meetings.

Design Fredrik Mattson

Depth from wall 37 mm
 Magnetic writing surface
 e3 certified 99% recyclable
 30-year warranty on writing surface



Article number	Name		Size w x h mm	Weight kg
92008	Note Whiteboard		805 x 805	5
92012	Note Whiteboard		1205 x 805	7
92018	Note Whiteboard		805 x 1805	11
9204	Note Wall Bracket Depository (3 Boards)			

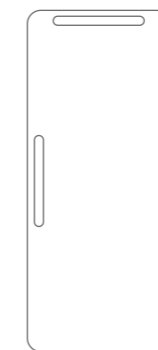

805 x 1805
92018

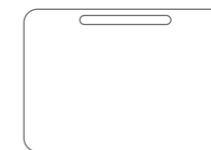

1205 x 805
92012

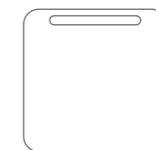

805 x 805
92008

Air Lines whiteboard

A ceramic steel writing board inspired by a classic note pad, with bevelled white edges instead of a frame. This gives the board a sense of floating on the wall. Can also be supplemented by a textile noticeboards (see Air Textile).

Concealed fittings
 Depth from wall 16 mm
 Magnetic ceramic steel writing surface
 e3 certified 99% recyclable
 30-year warranty on the writing surface

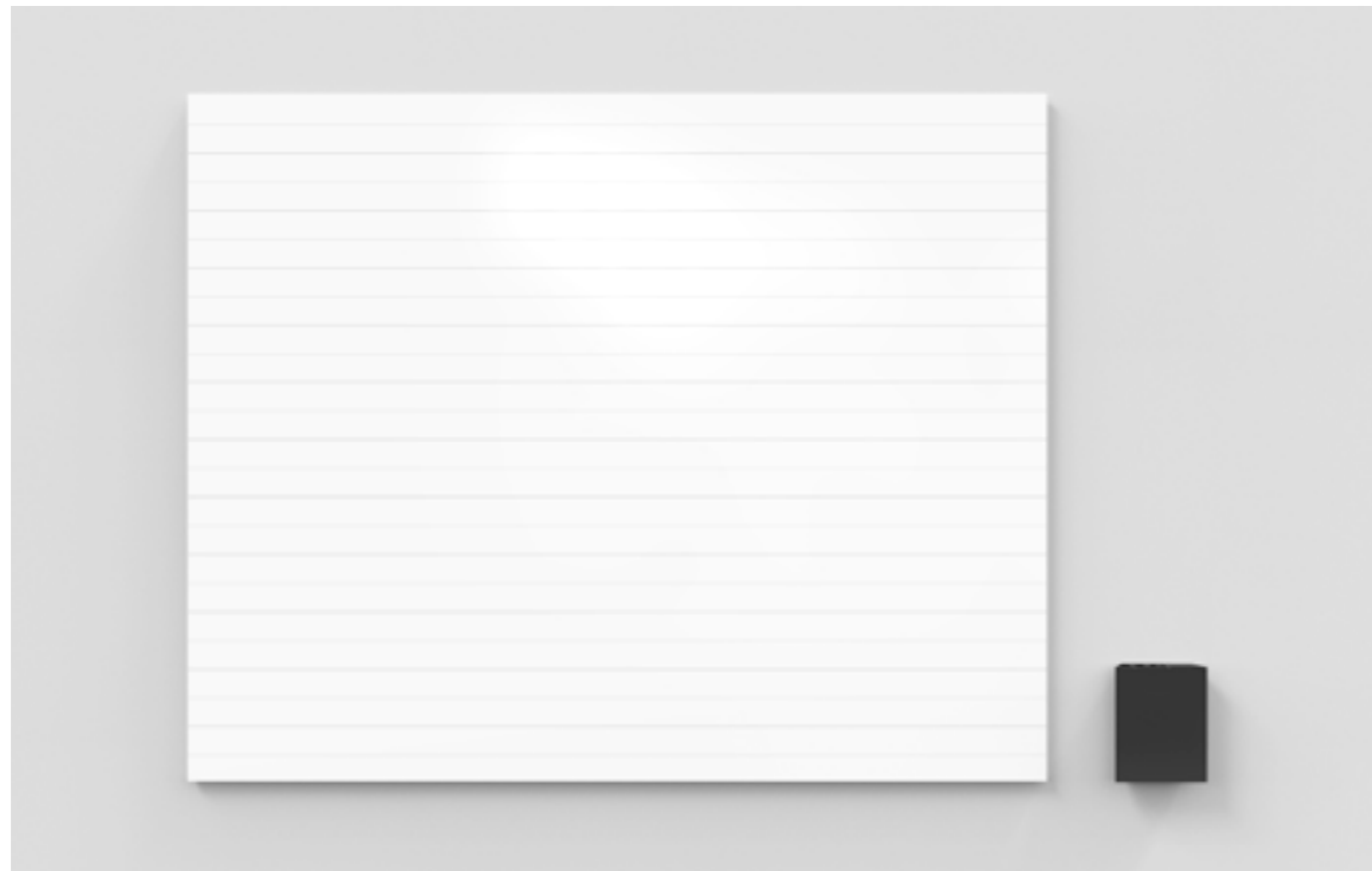

Article number	Name	Size w x h mm	Weight kg
27826AIR-LINES	Air Lines Whiteboard	990 x 1190	17
27827AIR-LINES	Air Lines Whiteboard	1490 x 1190	25
27828AIR-LINES	Air Lines Whiteboard	1990 x 1190	34
27829AIR-LINES	Air Lines Whiteboard	2490 x 1190	38
27830AIR-LINES	Air Lines Whiteboard	2990 x 1190	45



Air Flow whiteboard

A ceramic steel writing board with bevelled white edges instead of a traditional frame. The unique soft shape consists of a continuous curved line that gives the board a sense of flowing on the wall.

Design Christian Halleröd

Concealed fittings
 Depth from wall 16 mm
 Magnetic ceramic steel writing surface
 e3 certified 99% recyclable
 30-year warranty on the writing surface



Article number	Name	Size w x h mm	Weight kg
27826AIR-F	Air Flow Whiteboard	990 x 1190	15
27827AIR-F	Air Flow Whiteboard	1490 x 1190	23
27828AIR-F	Air Flow Whiteboard	1990 x 1190	30

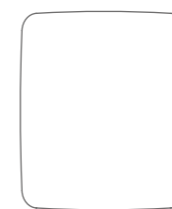

990 x 1190
27826AIR-F

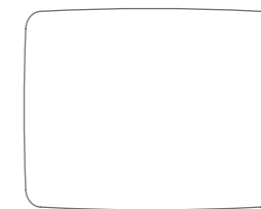

1490 x 1190
27827AIR-F

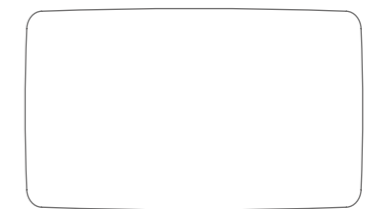

1990 x 1190
27828AIR-F

Air TV whiteboard

A ceramic steel whiteboard equipped to hang a TV screen. Thanks to bevelled white edges, the Air TV gives a sense of floating on the wall. The TV screen is mounted using included fixings, which fit all the usual VESA sizes. The board has a hole located behind the TV screen for cabling.

Concealed fittings
 Depth from wall 25 mm
 Magnetic writing surface
 e3 certified 99% recyclable
 30-year warranty on writing surface



Article number	Name	Size w x h mm	Weight kg
27829Air-TV	Air TV Whiteboard	2490 x 1190	41
27830Air-TV	Air TV Whiteboard	2990 x 1190	47

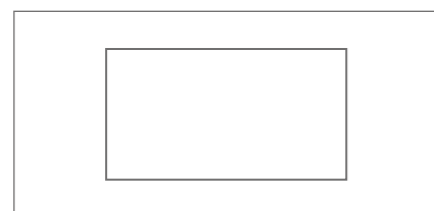

2490 x 1190
27829Air-TV

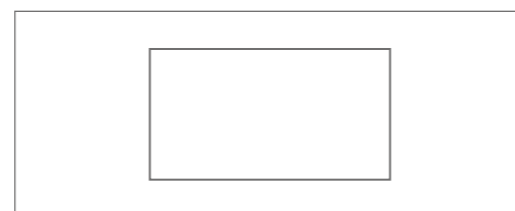

2990 x 1190
27830Air-TV

ONE whiteboard

Whiteboard with black or white aluminium frame with mitred corners. The ONE series includes fixed and mobile products with clean and functional form.

Design Christian Halleröd

Concealed fittings
 Depth from wall 20 mm
 Magnetic ceramic steel writing surface
 e3 certified 99% recyclable
 30-year warranty on the writing surface



Article number	Name	Size w x h mm	Weight kg
91126S	ONE Whiteboard, black frame	1007 x 1207	18
91127S	ONE Whiteboard, black frame	1507 x 1207	28
91128S	ONE Whiteboard, black frame	2007 x 1207	37
91126V	ONE Whiteboard, white frame	1007 x 1207	18
91127V	ONE Whiteboard, white frame	1507 x 1207	28
91128V	ONE Whiteboard, white frame	2007 x 1207	37

Edge whiteboard

Ceramic steel whiteboard with gently rounded corners, concealed fittings and a discrete black or white edging that gives the board a modern aesthetic.

Concealed fittings
 Depth from wall 20 mm
 Magnetic ceramic steel writing surface
 e3 certified 99% recyclable
 30-year warranty on the writing surface



Article number	Name	Size w x h mm	Weight kg
28826P	Whiteboard Edge, white frame	995 x 1195	15
28827P	Whiteboard Edge, white frame	1495 x 1195	23
28828P	Whiteboard Edge, white frame	1995 x 1195	30
28829P	Whiteboard Edge, white frame	2495 x 1195	38
28830P	Whiteboard Edge, white frame	2995 x 1195	45
27826P	Whiteboard Edge, black frame	995 x 1195	15
27827P	Whiteboard Edge, black frame	1495 x 1195	23
27828P	Whiteboard Edge, black frame	1995 x 1195	30
27829P	Whiteboard Edge, black frame	2495 x 1195	38
27830P	Whiteboard Edge, black frame	2995 x 1195	45

Acoustic Board sound absorbing whiteboard

Whiteboard that contains a 30 mm sound absorbing material. The soft interior in combination with the hard ceramic steel surface creates a unique sound absorption that captures low frequencies through resonance technology.

Concealed fittings
 Depth from wall 47 mm
 Magnetic ceramic steel writing surface
 e3 certified 99% recyclable
 30-year warranty on the writing surface

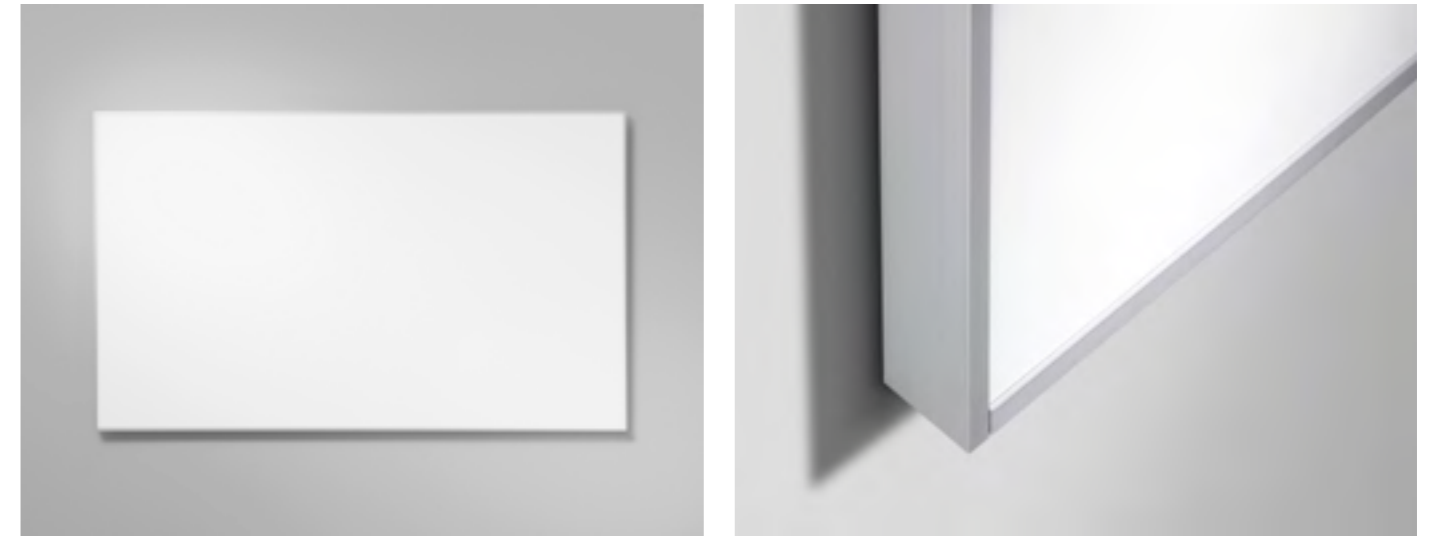

Article number	Name	Size w x h mm	Weight kg
27326	Acoustic Board, aluminium frame	1008 x 1205	12
27327	Acoustic Board, aluminium frame	1508 x 1205	18
27328	Acoustic Board, aluminium frame	2008 x 1205	24
27329	Acoustic Board, aluminium frame	2508 x 1205	30
27330	Acoustic Board, aluminium frame	3008 x 1205	36

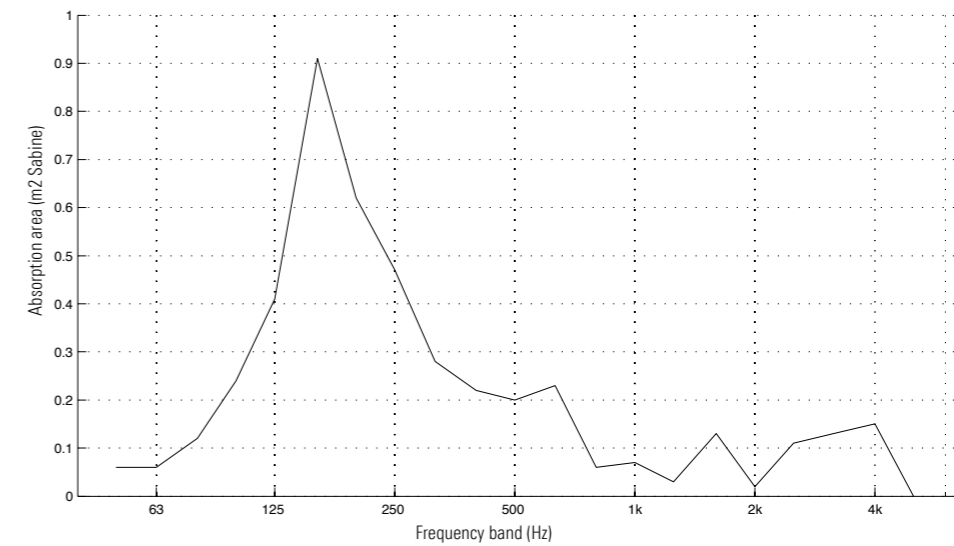

Boarder whiteboard

A classic whiteboard with a ceramic steel writing surface. Boarder is available with a white or natural anodised aluminium frame, combined with grey or white plastic corners. The board is easy to mount and is available in sizes up to 3 meters. An aluminium pen tray is included.

Concealed fittings
Depth from wall 19 mm
Magnetic ceramic steel writing surface
e3 certified 99% recyclable
30-year warranty on the writing surface



Article number	Name	Size w x h mm	Pen Tray mm	Weight kg
27820	Boarder whiteboard, aluminium frame	255 x 355	200	1
27821	Boarder whiteboard, aluminium frame	355 x 505	300	2
27822	Boarder whiteboard, aluminium frame	455 x 605	300	3
27823	Boarder whiteboard, aluminium frame	605 x 905	300	6
27824	Boarder whiteboard, aluminium frame	905 x 1205	300	13
27825	Boarder whiteboard, aluminium frame	1805 x 905	300	20
27826	Boarder whiteboard, aluminium frame	1005 x 1205	950	18
27827	Boarder whiteboard, aluminium frame	1505 x 1205	1450	21
27835	Boarder whiteboard, aluminium frame	1805 x 1205	1750	27
27828	Boarder whiteboard, aluminium frame	2005 x 1205	1950	28
27829	Boarder whiteboard, aluminium frame	2505 x 1205	2450	34
27830	Boarder whiteboard, aluminium frame	3005 x 1205	2950	41
28820	Boarder whiteboard, white aluminium frame	255 x 355	200	1
28821	Boarder whiteboard, white aluminium frame	355 x 505	300	2
28822	Boarder whiteboard, white aluminium frame	455 x 605	300	4
28823	Boarder whiteboard, white aluminium frame	605 x 905	300	7
28824	Boarder whiteboard, white aluminium frame	905 x 1205	300	13
28825	Boarder whiteboard, white aluminium frame	1805 x 905	300	21
28826	Boarder whiteboard, white aluminium frame	1005 x 1205	950	15
28827	Boarder whiteboard, white aluminium frame	1505 x 1205	1450	23
28835	Boarder whiteboard, white aluminium frame	1805 x 1205	1750	27
28828	Boarder whiteboard, white aluminium frame	2005 x 1205	1950	30
28829	Boarder whiteboard, white aluminium frame	2505 x 1205	2450	39
28830	Boarder whiteboard, white aluminium frame	3005 x 1205	2950	47

Boarder Sharp whiteboard

A classic whiteboard with a ceramic steel writing surface. Boarder Sharp is available in a white or natural anodised aluminium frame with mitred corners. The board is easy to mount and is available in sizes up to 3 meters. An aluminium pen tray is included.

Concealed fittings
Depth from wall 19 mm
Magnetic ceramic steel writing surface
e3 certified 99% recyclable
30-year warranty on the writing surface



Article number	Name	Size w x h mm	Pen Tray mm	Weight kg
27824GER	Boarder Sharp whiteboard, aluminium frame	905 x 1205	300	14
27825GER	Boarder Sharp whiteboard, aluminium frame	1805 x 905	300	21
27826GER	Boarder Sharp whiteboard, aluminium frame	1005 x 1205	950	15
27827GER	Boarder Sharp whiteboard, aluminium frame	1505 x 1205	1450	23
27828GER	Boarder Sharp whiteboard, aluminium frame	2005 x 1205	1950	30
27829GER	Boarder Sharp whiteboard, aluminium frame	2505 x 1205	2450	38
27830GER	Boarder Sharp whiteboard, aluminium frame	3005 x 1205	2950	45

Boarder 1530 whiteboard

Our classic whiteboard can also be supplied in a 1530 mm height with white or natural anodised aluminium frame combined with grey or white plastic corners. An aluminium pen tray is included.

Concealed fittings
Depth from wall 19 mm
Magnetic ceramic steel writing surface
e3 certified 99% recyclable
30-year warranty on the writing surface

Article number	Name	Size w x h mm	Pen Tray mm	Weight kg
27227	Boarder whiteboard, aluminium frame	1505 x 1530	1450	29
27228	Boarder whiteboard, aluminium frame	2005 x 1530	1950	30
27229	Boarder whiteboard, aluminium frame	2505 x 1530	2450	39
27230	Boarder whiteboard, aluminium frame	3005 x 1530	2950	47
28227	Boarder whiteboard, aluminium frame	1505 x 1530	1450	23
28228	Boarder whiteboard, aluminium frame	2005 x 1530	1950	30
28229	Boarder whiteboard, aluminium frame	2505 x 1530	2450	39
28230	Boarder whiteboard, aluminium frame	3005 x 1530	2950	47



Writing Boards – Glass

Silk-glass

We're introducing Silk-glass, a state-of-the-art material with a smooth, silky matt surface. No reflections, but just as good for writing and erasing as any other glass. The unique silk glass surface gives our colours a deep appearance and a rich, silky hue that responds to the changing light throughout the day. A revolutionary matte writing surface.

Silk-glass is now available with our Mood glass board, in sizes 1000x1000, 1250x1000, 1500x1000 and 2000x1000mm.

1000 x 1000 41534M	1250 x 1000 41535M	1500 x 1000 41536M	2000 x 1000 41537M
-----------------------	-----------------------	-----------------------	-----------------------



Mood Wall glass board

Mood Wall is a magnetic glass writing board, available in 24 selected colours. The board is made of tempered low iron glass without any shades of green, which gives the glass optimum finish and colour reproduction. Using coupling magnets (1570-28-3), multiple boards can be connected, with subtle joints, to create large writing surfaces. Pen tray made of birch or plexiglass are sold separately.

Concealed fittings
Depth from wall 12 mm
Tempered, low iron glass
24 Mood colours
Magnetic

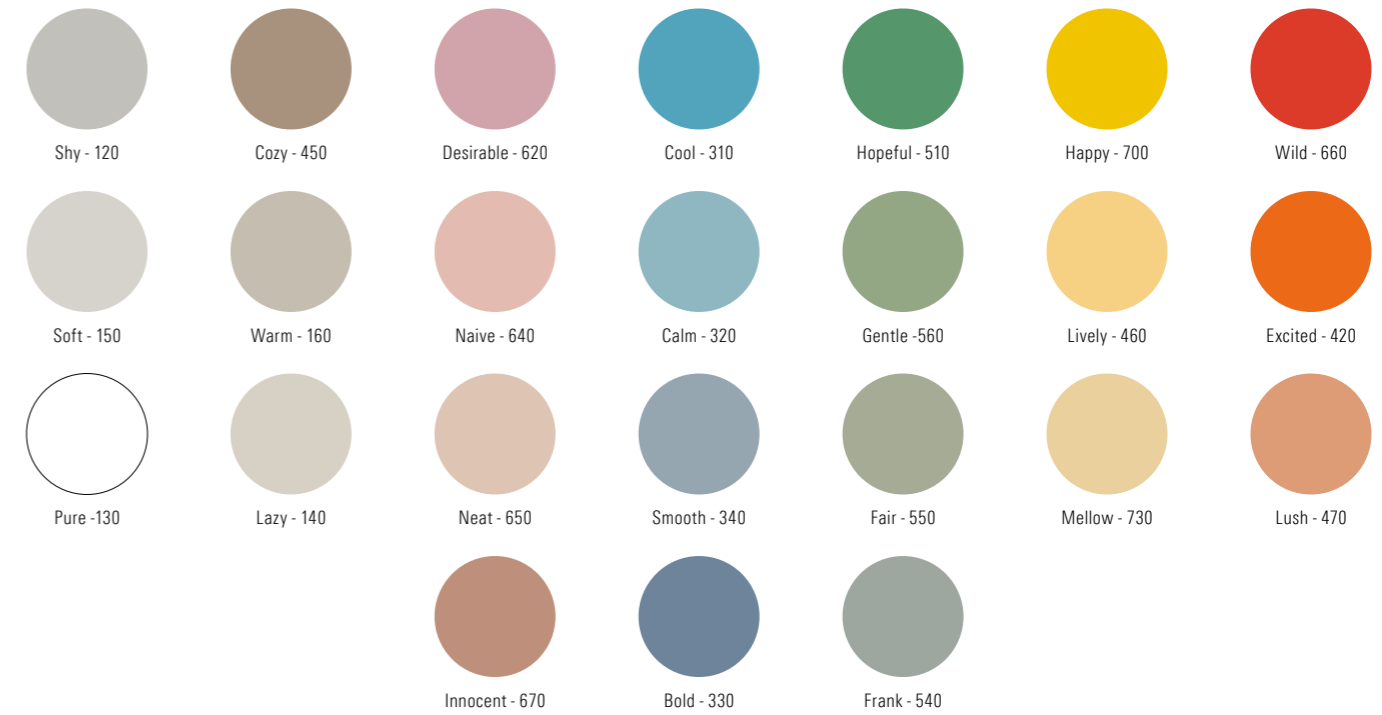

Article number	Name	Size w x h mm	Weight kg
41531-color code	Mood Wall	300 x 300	2
41532-color code	Mood Wall	500 x 500	3
41533-color code	Mood Wall	750 x 750	7
41534-color code	Mood Wall	1000 x 1000	12
41535-color code	Mood Wall	1250 x 1000	18
41535Z-color code	Mood Wall	1000 x 1250	18
41536-color code	Mood Wall	1500 x 1000	21
41536Z-color code	Mood Wall	1000 x 1500	21
41537-color code	Mood Wall	2000 x 1000	28
41537Z-color code	Mood Wall	1000 x 2000	28
41545-color code	Mood Wall	1500 x 500	13
41545Z-color code	Mood Wall	500 x 1500	13
41547-color code	Mood Wall	1500 x 750	18
41547Z-color code	Mood Wall	750 x 1500	18

Custom colours and sizes available on request

41534M-color code	Mood Wall Silk-glass	New	1000 x 1000	12
41535M-color code	Mood Wall Silk-glass	New	1250 x 1000	18
41535ZM-color code	Mood Wall Silk-glass	New	1000 x 1250	18
41536M-color code	Mood Wall Silk-glass	New	1500 x 1000	21
41536ZM-color code	Mood Wall Silk-glass	New	1000 x 1500	21
41537M-color code	Mood Wall Silk-glass	New	2000 x 1000	28
41537ZM-color code	Mood Wall Silk-glass	New	1000 x 2000	28

Custom colours available on request

1570-28-3	Coupling magnets Mood Wall
-----------	----------------------------

Flow Wall glass board

A magnetic glass writing board with a unique soft shape that consists of a continuous curved line, giving the board a sense of flowing on the wall. Available in 24 selected colours. The board is made of tempered low iron glass without any shades of green, which gives the glass optimum finish and colour reproduction.

Design Christian Halleröd

Concealed fittings
 Depth from wall 12 mm
 Tempered, low iron glass
 24 Mood colours
 Magnetic

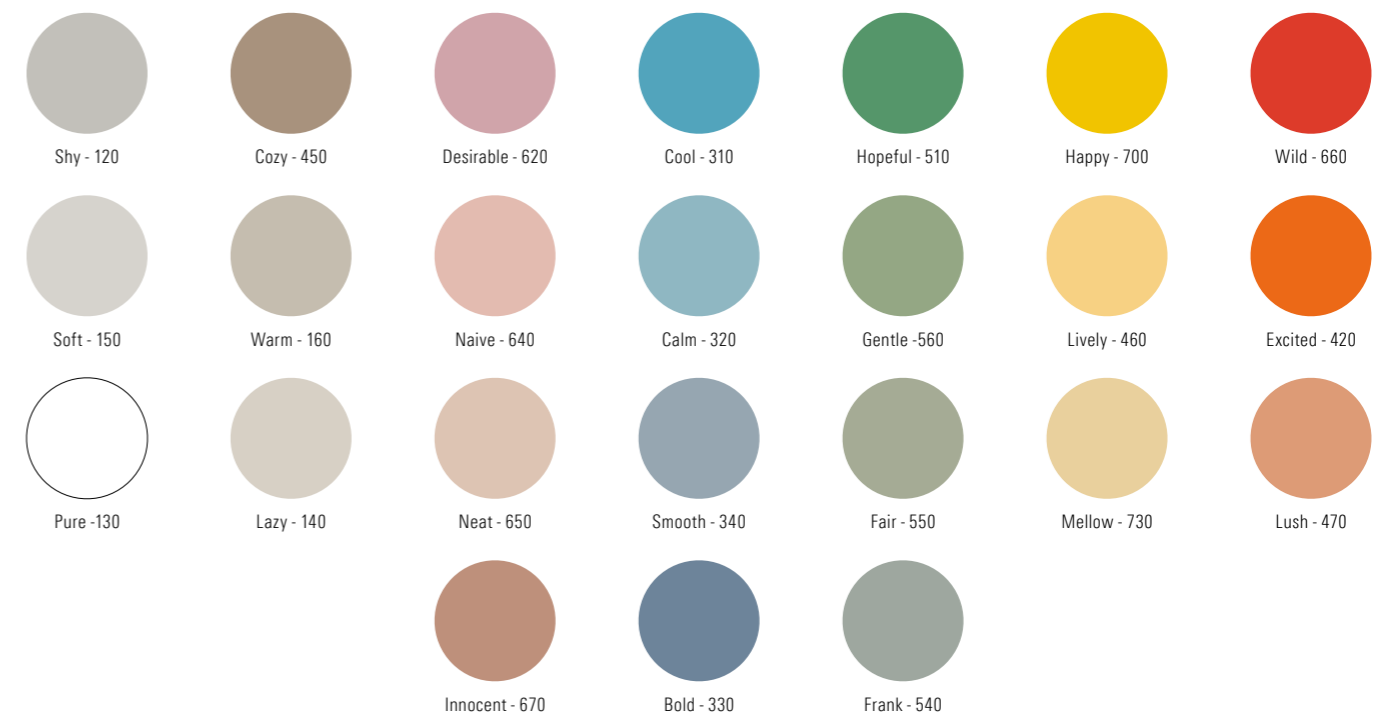
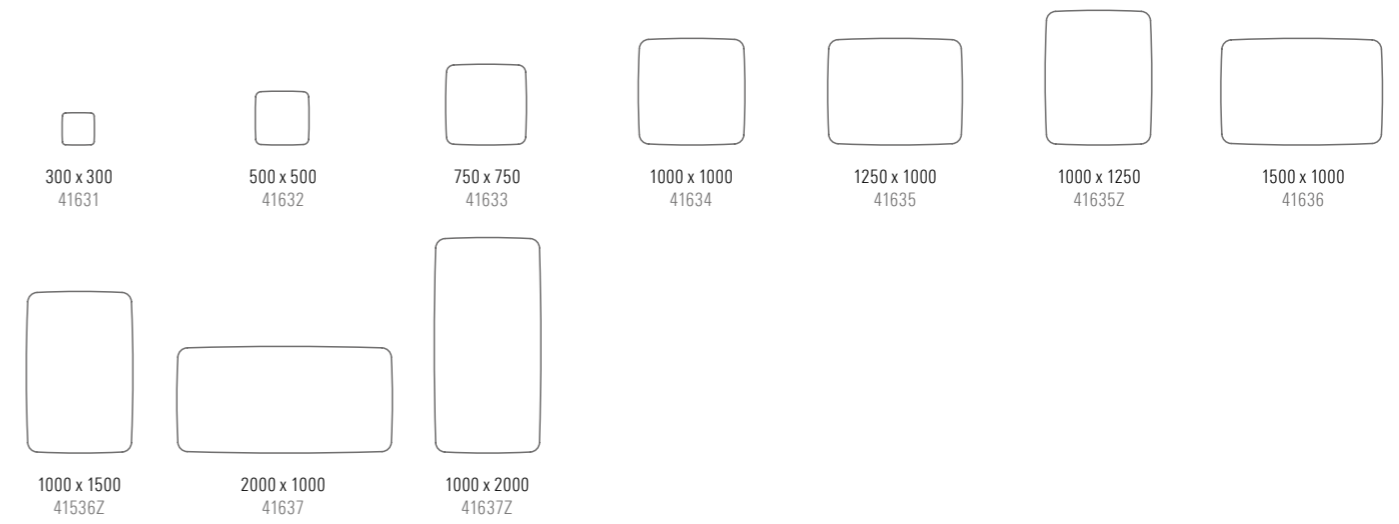

Article number	Name	Size w x h mm	Weight kg
41631-colour code	Mood Flow	300 x 300	1,5
41632-colour code	Mood Flow	500 x 500	3
41633-colour code	Mood Flow	750 x 750	7
41634-colour code	Mood Flow	1000 x 1000	12
41635-colour code	Mood Flow	1250 x 1000	18
41635Z-colour code	Mood Flow	1000 x 1250	18
41636-colour code	Mood Flow	1500 x 1000	21
41636Z-colour code	Mood Flow	1000 x 1500	21
41637-colour code	Mood Flow	2000 x 1000	28
41637Z-colour code	Mood Flow	1000 x 2000	28

Mood Fabric Wall

Glass writing board with softly rounded corners and a textile-covered frame. Available with full glass surface or combined with a textile-covered, sound absorbing surface or cork. Add separate modules to ready-made combinations to create unique multifunctional surfaces.

Design Christian Halleröd & Matti Klenell

Concealed fittings
 Tempered, low iron glass
 Magnetic writing surface
 8 selected colour combinations
 48 mm sound absorbent-filling

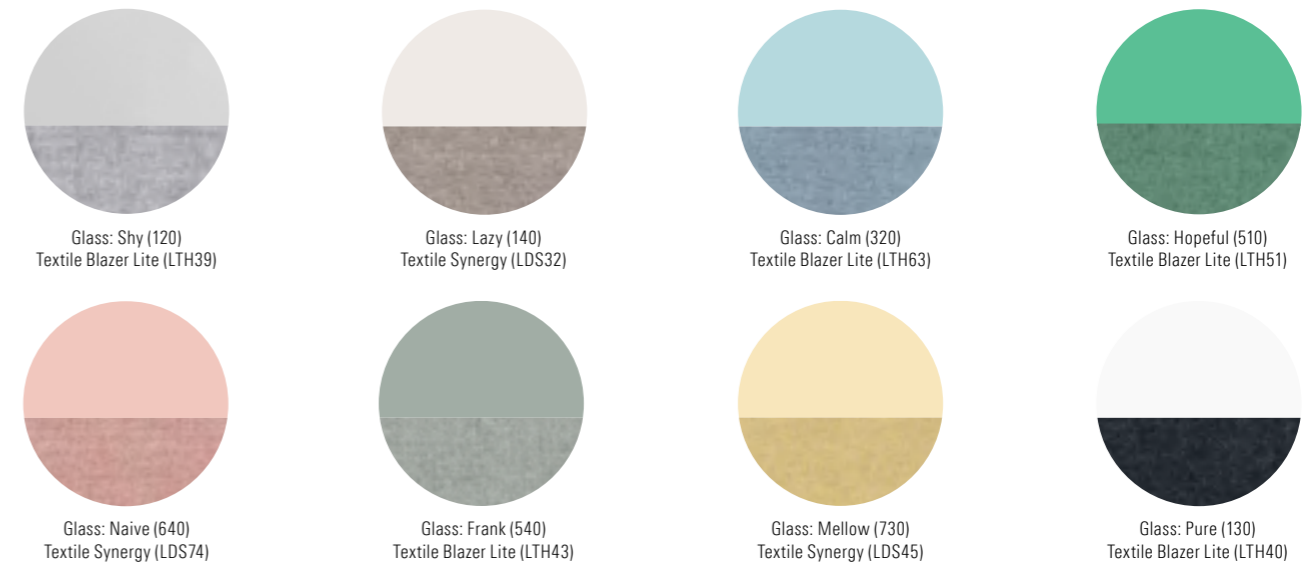

Article number	Name	Total size w x h mm	Size glass / textile w x h mm	Weight kg
70701-textile-glass	Mood Fabric Wall, full glass	1750 x 1000	1750 x 1000	44
70702-textile-glass	Mood Fabric Wall, glass Left	1500 x 1000	1000 x 1000 / 500 x 1000	33
70702Z-textile-glass	Mood Fabric Wall, glass right	1500 x 1000	1000 x 1000 / 500 x 1000	33
70703-textile-glass	Mood Fabric Wall, glass Left	1750 x 1000	1250 x 1000 / 500 x 1000	40
70703Z-textile-glass	Mood Fabric Wall, glass right	1750 x 1000	1250 x 1000 / 500 x 1000	40
70704-textile-glass	Mood Fabric Wall, glass Left	2000 x 1000	1500 x 1000 / 500 x 1000	44
70704Z-textile-glass	Mood Fabric Wall, glass right	2000 x 1000	1500 x 1000 / 500 x 1000	44
70725-textile-glass	Mood Fabric Wall, glass center	2500 x 1000	1500 x 1000 / 500+500 x 1000	47

Bloc

Square boards with softly rounded corners, combining a variety of materials and functions. Bloc is available as a writing board, a noticeboard, a sound absorber or a news stand. Can be placed on its own or in larger multifunctional groups. Available in 8 selected glass/textile combinations, solid cork or a birch/oak bentwood frame.

Design Christian Halleröd & Matti Klenell

Magnetic glass boards
 Depth from wall 50 mm
 8 colour combinations
 Tempered, low iron glass
 48 mm sound absorbent filling

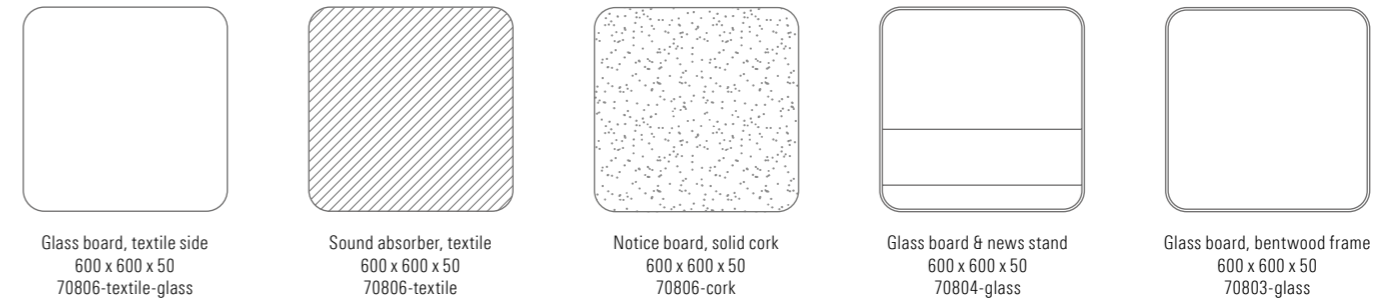

Glass board, textile side 600 x 600 x 50 70806-textile-glass
 Sound absorber, textile 600 x 600 x 50 70806-textile
 Notice board, solid cork 600 x 600 x 50 70806-cork
 Glass board & news stand 600 x 600 x 50 70804-glass
 Glass board, bentwood frame 600 x 600 x 50 70803-glass

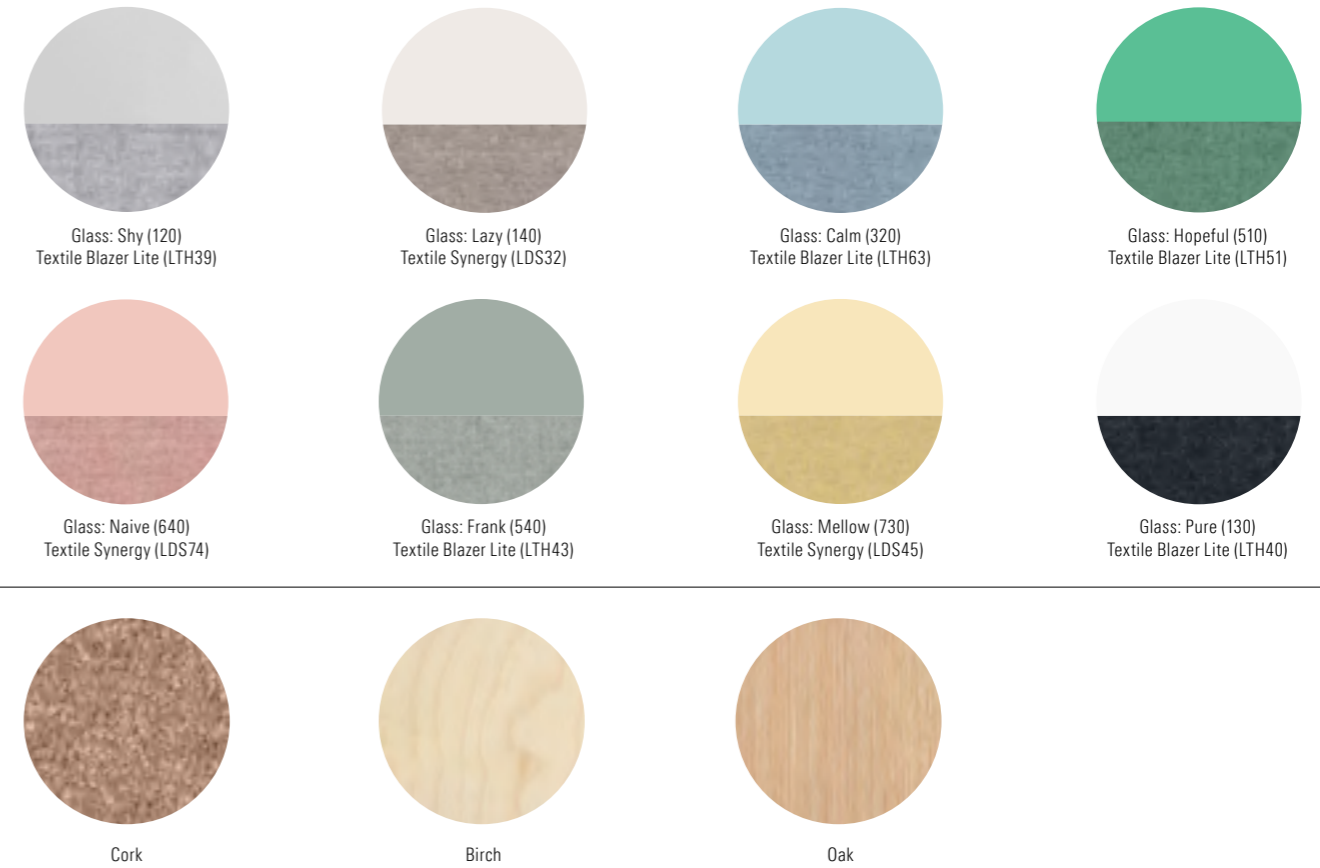

Glass: Shy (120) Textile Blazer Lite (LTH39)
 Glass: Lazy (140) Textile Synergy (LDS32)
 Glass: Calm (320) Textile Blazer Lite (LTH63)
 Glass: Hopeful (510) Textile Blazer Lite (LTH51)
 Glass: Naive (640) Textile Synergy (LDS74)
 Glass: Frank (540) Textile Blazer Lite (LTH43)
 Glass: Mellow (730) Textile Synergy (LDS45)
 Glass: Pure (130) Textile Blazer Lite (LTH40)

Cork Birch Oak

Article number	Name	Size w x h x d mm	Weight kg
70806-textile colour code	Bloc Textile	600 x 600 x 50	3
70806-textile-glass colour code	Bloc Glass	600 x 600 x 50	10
70806-C	Bloc Cork	600 x 600 x 50	9
70803-glass colour code	Bloc Frame, Birch	600 x 600 x 50	8
70804-glass colour code	Bloc News, Birch	600 x 600 x 50	8
70814-glass colour code	Bloc News, Oak	New 600 x 600 x 50	8
70813-glass colour code	Bloc Frame, Oak	New 600 x 600 x 50	8



Right, so it's too big a question. Goddamn flippin' it around. Places aren't asking anything of me. I feel like bookstores that aren't asking anything and what they're about. Therefore they're suggesting you want in a manner conducive to their planned surrounding.

Which is easy to do. They're places designed for a specific experience, so I think it's the non-places that are asking the most of you. They only tell you little things. A specific planned experience leaves no room?

I wouldn't go that extra step. I would hold back at the unknown. It's like meeting someone who doesn't just want to talk at you. You look at them and they look at you and you don't get anything concrete. They're inviting you to begin, but you can't do anything wrong. You're just going to make it up as you go. That's a truly exciting feeling. Wandering is letting go of presumptions. It is a search for the beginner's mind. A love affair with the world unstated. I think that's why, in lieu of the swamp, you go to the forgotten urban places. They've become open again, or something.

TALKING WITH JUSTIN APPERLEY

Do you remember the first time you were conscious of the fact that you were traveling, not for the purpose of reaching a destination, but for the sake of MOVING?

I totally do! It was after I finished my degree and left the Yukon. I travelled with a buddy from Western Canada all the way to St. John's, Newfoundland. ARRIVED at my destination, and freaked out that I completed my goal. I decided to keep moving and hitch hike back out west to Tofino, British Columbia. It keeps on getting worse and worse every time I stop after a long time of moving everywhere.

Meaning you just wanna get back on the road again?

Totally. I'm pretty sure at this point in my life hitting the road is more of a stable lifestyle for me than trying to figure out my shit in one



Writing Board Accessories

Mood Box

Square or softly rounded, smart and elegant storage for pens, eraser, cleaning spray, remote control, etc. Black aluminium body with a glass front in any of our 24 selected colours. The storage compartment is equipped with two removable dividers.

Design Christian Halleröd

Tempered, low iron glass
Glass front in 24 Mood colours
Black aluminium body



Article number	Name	Size w x h x d mm	Weight kg
11545-130	Mood Box black, white glass, Pure	410 x 220 x 66	5
11545-colour code	Mood Box black, coloured glass, Mood colours	410 x 220 x 66	5

Colour chart on page 91

Mood Pocket

A smart storage solution for pens and eraser. The Mood Pocket has a glass front that is available in any of our 24 selected colours. The magnetic eraser is hidden and accessed with a simple click. White aluminium body.

Design Christian Halleröd

Glass front in 24 Mood colours
Tempered, low iron glass
1 board eraser + 3 spare felt pads
3 black felt-tip pens



Article number	Name	Size w x h mm	Weight kg
40205-V-colour code	Mood pocket white aluminium, glass front	160 x 200	1,5

Colour chart on page 91

Air Pocket

A smart storage for pens and eraser. With a discreet design, the Air Pocket is the perfect match for our range of whiteboards. The magnetic eraser is hidden and accessed with a simple click. Available in white or black aluminium.

Design Christian Halleröd

1 board eraser + 3 spare felt pads
3 black felt-tip pens



Article number	Name	Size w x h mm	Weight kg
40205-S	Air Pocket Black aluminium	160 x 200 x 34	1,5
40205-V	Air Pocket White aluminium	160 x 200 x 34	1,5

Accessory kit Black

Set of accessories containing four pens, five magnets, a spray bottle for cleaning with water, a board eraser, three felt pads, a microfibre cloth and four magnetic holders for individual pens.

- 4 felt-tip pens + 4 pen holders
- 1 board eraser + 3 spare felt pads
- 5 magnets
- 1 spray bottle for water
- 1 microfibre cloth



Article number	Name
40445	Accessory kit Black. Available May 2018. Replaces 40245GLAS New
40245GLAS	Start set black. Discontinued May 2018. Replaced by 40445



40245GLAS

Bowl toolbox

A smart and handy desk storage for whiteboard pens and other office items. Available in 3 selected colors with a smooth rubber coated surface.

Design Christian Halleröd

- Earth (red)
- Moss (green)
- Fog (gray)



Article number	Name		Size w x h mm
40481	Bowl Earth. Available June 2018. New		150 x 150
40482	Bowl Fog. Available June 2018. New		150 x 150
40483	Bowl Moss. Available June 2018. New		150 x 150



Fog

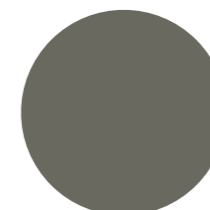

Moss

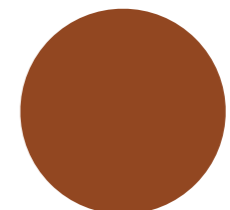

Earth

Startset Birch & Cork

Set of accessories in birch or cork. Contains four pens, five magnets, a spray bottle for cleaning with water, a board eraser, five spare felt pads, a microfibre cloth and four magnetic holders for individual pens.

Design Matti Klenell

4 felt-tip pens + 4 pen holders
1 board eraser + 5 spare felt pads
5 magnets
1 spray bottle for water
1 microfibre cloth



Article number	Name
40245-B	Accessory kit Birch, extra strong magnets
40245-C	Accessory kit Cork, extra strong magnets
40245-SC	Accessory kit Cork Black, extra strong magnets

Pens & penholders

Article number	Name
40290	Felt-tip pens 4/pack (black, red, green, blue)
40294	Felt-tip pens 4/pack (black)
40264	Felt-tip pens 4/ pack (green, pink, yellow, orange)
40263	Pen for glassboards (white)
40278	Magnetic pen holder single 4/pack, for whiteboards and glassboards

Board eraser & felt sets

Article number	Name
40459	Board eraser, black, magnetic. Available May 2018. Replaces 40359 New
40460	Felt set for board eraser 40459, 10pcs
40359	Board eraser, black, magnetic. Discontinued May 2018. Replaced by 40459
40360	Felt set for board eraser 40359, 5pcs
40262	Micro fiber cloth (5pcs)
40044	Cleaning liquid 0,25l

Magnets

Article number	Name
40442	Magnets, strong, black, 10pcs. Available May 2018. Replaces 40242S New
40242S	Magnets, strong, black, 10pcs. Discontinued May 2018. Replaced by 40442
40242C	Magnets, strong, cork 5pcs
40242SC	Magnets, strong, black cork 5pcs
40242B	Magnets, strong, birch 5pcs
40042K	Magnets, strong, satin chrome, 5pcs

Pen Tray Air whiteboard & Mood glass board

Article number	Name	Size w mm
1215T	Pen Tray, plexi, transparent 200mm	200
1215S	Pen Tray, plexi, black 200mm	200
1215V	Pen Tray, plexi, white 200mm	200
1216T	Pen Tray, plexi, transparent 500mm	500
1216S	Pen Tray, plexi, black 500mm	500
1216V	Pen Tray, plexi, white 500mm	500
1218-B	Pen Tray, birch, 200mm	200



Conference Cabinets

Mood Conference whiteboard

Conference cabinet concealing a magnetic ceramic steel whiteboard. Sliding doors in tempered low iron glass for optimum finish and colour reproduction. The doors provide their own magnetic writing surface and are available in any of our 24 Mood colours.

Design Christian Halleröd

Tempered, low iron glass
Glass doors in 24 Mood colours
Magnetic writing surface
e3 certified 99% recyclable
30-year warranty on writing surface



Article number	Name	Size w x h x d mm	Weight kg
12500-130	Mood Conference, anodized alu-frame, black alu-body, opal white glass (Pure)	1685 x 1015 x 85	99
12500-colour code	Mood Conference, anodized alu-frame, black alu-body, coloured glass, Mood colours	1685 x 1015 x 85	99
Accessories			
11545-130	Mood Box black, white glass, Pure	410 x 220 x 66	5
11545-colour code	Mood Box black, coloured glass, Mood colours	410 x 220 x 66	5

Colour chart on page 91



3200 x 1015



1685 x 1015



85 x 1015

Mood Conference TV

A modern conference cabinet for TV screens up to 65" (1530 x 880 x 75 mm). The sliding doors in tempered glass provide a magnetic writing surface and are available in any of 24 our Mood colours. The TV screen is easy to mount with the included fittings.

Design Christian Halleröd

For TVs up to 65"
TV fittings supplied
Tempered, low iron glass
Glass doors in 24 Mood colours
Magnetic writing surface



Article number	Name	Size w x h x d mm	Weight kg
13500TV-130	Mood Conference TV, black frame, opal white glass (Pure)	1685 x 1143 x 93	115
13500TV-colour code	Mood Conference TV, black frame, coloured glass, Mood colours	1685 x 1143 x 93	115
Accessories			
11545-130	Mood Box black, white glass, Pure	410 x 220 x 66	5
11545-colour code	Mood Box black, coloured glass, Mood colours	410 x 220 x 66	5

Colour chart on page 91

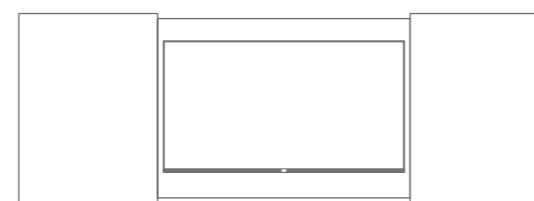

3200 x 1143



1685 x 1143



93 x 1143



Mobile Writing Boards & Flipchart Easels

Mood Fabric Mobile

A mobile glass writing board with a fabric-covered, sound-absorbent back. The Mood Fabric is a versatile screen that offers a seamless combination of materials and functions. Available in two sizes: a small model with a full glass front and a large model with a glass and textile front. Both have a textile-covered back with a sound-absorbent filling. Choose from 8 selected colour combinations. Feet and castors in black or grey are sold separately.

Design Christian Halleröd & Matti Klenell

Tempered, low iron glass
Magnetic writing surface
8 selected colour combinations
45 mm sound absorbent-filling

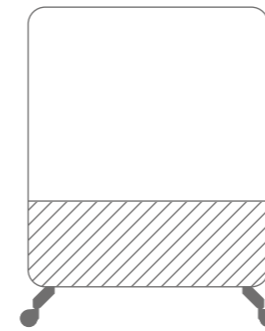

Mood Fabric Mobile
1500 x 1960
Front glass/textile

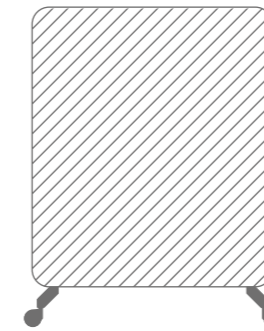

Mood Fabric Mobile
1500 x 1960
Back textile

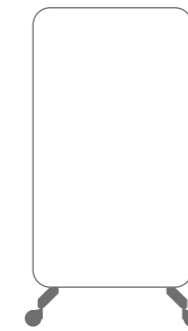

Mood Fabric Mobile
1000 x 1960
Front glass

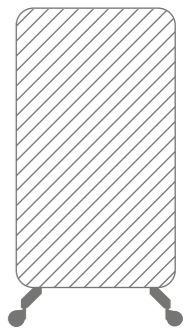

Mood Fabric Mobile
1000 x 1960
Back textile



Glass: Shy (120)
Textile Blazer Lite (LTH39)



Glass: Lazy (140)
Textile Synergy (LDS32)



Glass: Calm (320)
Textile Blazer Lite (LTH63)

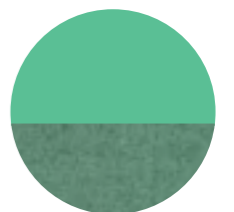

Glass: Hopeful (510)
Textile Blazer Lite (LTH51)



Glass: Naive (640)
Textile Synergy (LDS74)

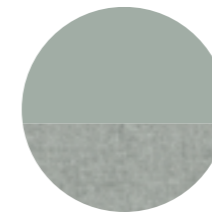

Glass: Frank (540)
Textile Blazer Lite (LTH43)

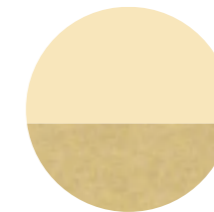

Glass: Mellow (730)
Textile Synergy (LDS45)



Glass: Pure (130)
Textile Blazer Lite (LTH40)

Article number	Name	Size w x h mm	Weight kg
70501-textile-glass	Mood Fabric Mobile	1000 x 1960	44
70504-textile-glass	Mood Fabric Mobile	1500 x 1960	53
1755	Mood Fabric Foot/ Casters grey (sold separately)		4
1755-S	Mood Fabric Foot/ Casters black (sold separately)		4

Wood mobile whiteboard

This mobile whiteboard is crafted from solid oak with a contrasting crisp white enameled steel writing surface. Sharp lines and attention to every little detail makes this piece of furniture a sophisticated addition to any professional space.

Design Christian Halleröd

Magnetic ceramic steel writing surface
Oak-veneered backside
e3 certified 99% recyclable steel
Adjustable flipchart hooks included

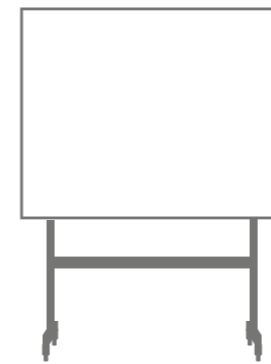

1508 x 1960 x 500



708 x 1960 x 500



Oak

Article number	Name		Size w x h x d mm	Weight kg
81095	Wood Mobile	New	708 x 1960 x 500	20
81027	Wood Mobile	New	1508 x 1960 x 500	38

Mono mobile glass board

This mobile glass board combines sharp lines with all monochrome colors. Available in white, two shades of grey and a soft yellow color, this piece of furniture is a contemporary addition to any modern office space.

Design Christian Halleröd

- Tempered, low iron glass
- 4 monochrome colors
- Magnetic writing surface
- Adjustable flipchart hooks included



1507 x 1960 x 500



707 x 1960 x 500

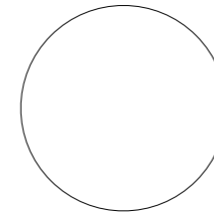

Pure - 130



Soft - 150

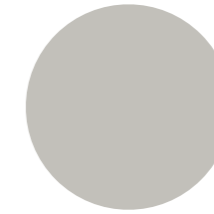

Shy - 120

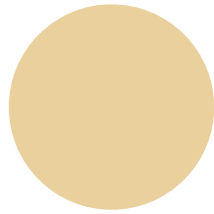

Mellow - 730

Article number	Name		Size w x h mm	Weight kg
91095-130	Mono Pure	New	707 x 1960	24
91095-120	Mono Shy	New	707 x 1960	24
91095-150	Mono Soft	New	707 x 1960	24
91095-730	Mono Mellow	New	707 x 1960	24
91027-130	Mono Pure	New	1507 x 1960	38
91027-120	Mono Shy	New	1507 x 1960	38
91027-150	Mono Soft	New	1507 x 1960	38
91027-730	Mono Mellow	New	1507 x 1960	38

Mood Mobile & Flow Mobile

Mobile glass writing board available with sharp corners or a softly rounded Flow shape. Tempered, low iron glass guarantees a vibrant finish in every of our 24 colours. Feet, casters and flip chart hooks in polished aluminium.

Design Christian Halleröd

Tempered, low iron glass
24 Mood colours
Magnetic writing surface



650 x 1960



650 x 1960

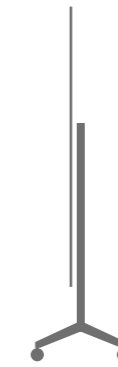

500 x 1960



Shy - 120



Cozy - 450



Desirable - 620



Cool - 310



Hopeful - 510



Happy - 700



Wild - 660



Soft - 150



Warm - 160

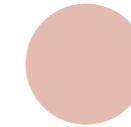

Naive - 640



Calm - 320



Gentle - 560



Lively - 460



Excited - 420

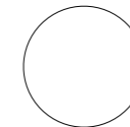

Pure - 130



Lazy - 140



Neat - 650



Smooth - 340



Fair - 550



Mellow - 730

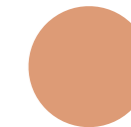

Lush - 470



Innocent - 670



Bold - 330



Frank - 540

Article number	Name	Size w x h x d mm	Weight kg
12475-130	Mood Mobile, Optical White (Pure), incl. flip chart hooks	650 x 1960 x 500	20
12475-colour code	Mood Mobile, Mood Colour, incl. flip chart hooks	650 x 1960 x 500	20
12675-130	Mood Flow Mobile, Optical White (Pure), incl. flip chart hooks	650 x 1960 x 500	24
12675-colour code	Mood Flow Mobile, Mood Colour, incl. flip chart hooks	650 x 1960 x 500	24
1369	Flip chart holder polished, pair		

M3 mobile double-sided whiteboard

The M3 Mobile is a double-sided mobile whiteboard with magnetic ceramic steel writing surfaces. Available in two sizes with black or natural anodised aluminium frame. Polished aluminium legs with 4 castors, two of which lock.

Design Christian Halleröd

Magnetic writing surface
e3 certified 99% recyclable
30-year warranty on writing surface

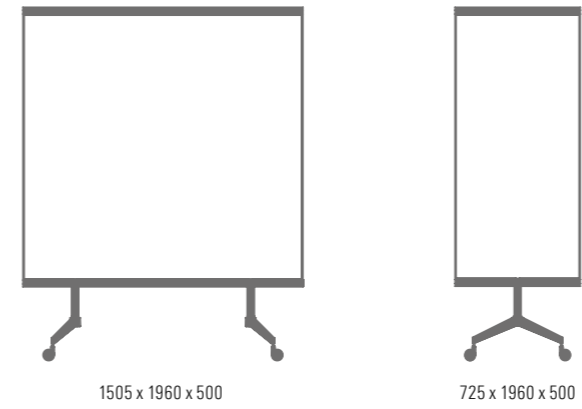

Article number	Name	Size w x h mm	Weight kg
12495	M3 Flip Chart Easel Mobile nature frame incl. flip chart holder	725 x 1960	34
12455	M3 Mobile nature frame	1505 x 1960	48
12429	M3 flip chart holder nature		1

ONE flip chart easel

The ONE flip chart is a modern take on the classic three-legged flip chart easel. Rounded legs and a prominent frame give the easel a subtle and stylish look. Magnetic ceramic steel writing surface and adjustable flip chart hooks. Available in black or white.

Design Christian Halleröd

Magnetic writing surface
e3 certified 99% recyclable
30-year warranty on writing surface
Adjustable flip chart hooks



Article number	Name	Size b x h x d mm	Weight kg
91090S	ONE Flip Chart Easel Black	707 x 1960 x 650 (707 x 1207)	23
91090V	ONE Flip Chart Easel White	707 x 1960 x 650 (707 x 1207)	23

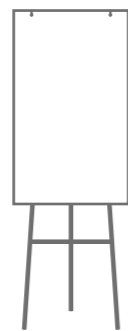

707 x 1960 x 650

ONE mobile flip chart easel

The ONE mobile flip chart is a modern take on the classic mobile flip chart easel. Rounded legs and a prominent frame give the easel a subtle and stylish look. Magnetic ceramic steel writing surface and adjustable flip chart hooks. Available in black or white. Four white or black castors, two of which lock.

Design Christian Halleröd

Magnetic writing surface
e3 certified 99% recyclable
30-year warranty on writing surface
Adjustable flip chart hooks



Article number	Name	Size b x h x d mm	Weight kg
91095S	ONE Mobile Flip Chart Easel Black	707 x 1960 x 500 (707 x 1207)	24
91095V	ONE Mobile Flip Chart Easel White	707 x 1960 x 500 (700 x 1207)	24



707 x 1960 x 500

ONE mobile whiteboard

Mobile whiteboard with magnetic ceramic steel writing surface. The black or white aluminium frame makes the writing surface stand out clearly. Four white or black castors, two of which lock. Stand and rear side in same colour as frame.

Design Christian Halleröd

Magnetic writing surface
e3 certified 99% recyclable
30-year warranty on writing surface
Adjustable flip chart hooks



Article number	Name	Size b x h x d mm	Weight kg
91027V	ONE Mobile Whiteboard White	1507 x 1960 x 500 (1507 x 1207)	32
91027S	ONE Mobile Whiteboard Black	1507 x 1960 x 500 (1507 x 1207)	32
91028V	ONE Mobile Whiteboard White	2007 x 1960 x 500 (2007 x 1207)	39
91028S	ONE Mobile Whiteboard Black	2007 x 1960 x 500 (2007 x 1207)	39

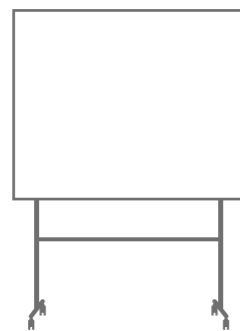

1507 x 1960 x 500

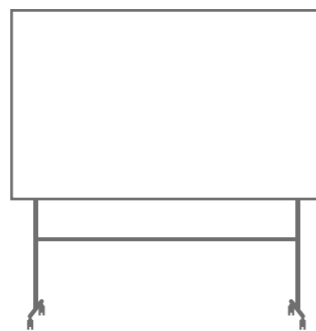

2007 x 1960 x 500

ONE mobile double-sided whiteboard

Double-sided mobile whiteboard with two magnetic ceramic steel writing surfaces. The black or white aluminium frame makes the writing surface stand out clearly. Rounded legs and four white or black castors, two of which lock.

Design Christian Halleröd

Magnetic writing surface
e3 certified 99% recyclable
30-year warranty on writing surface
Adjustable flip chart hooks

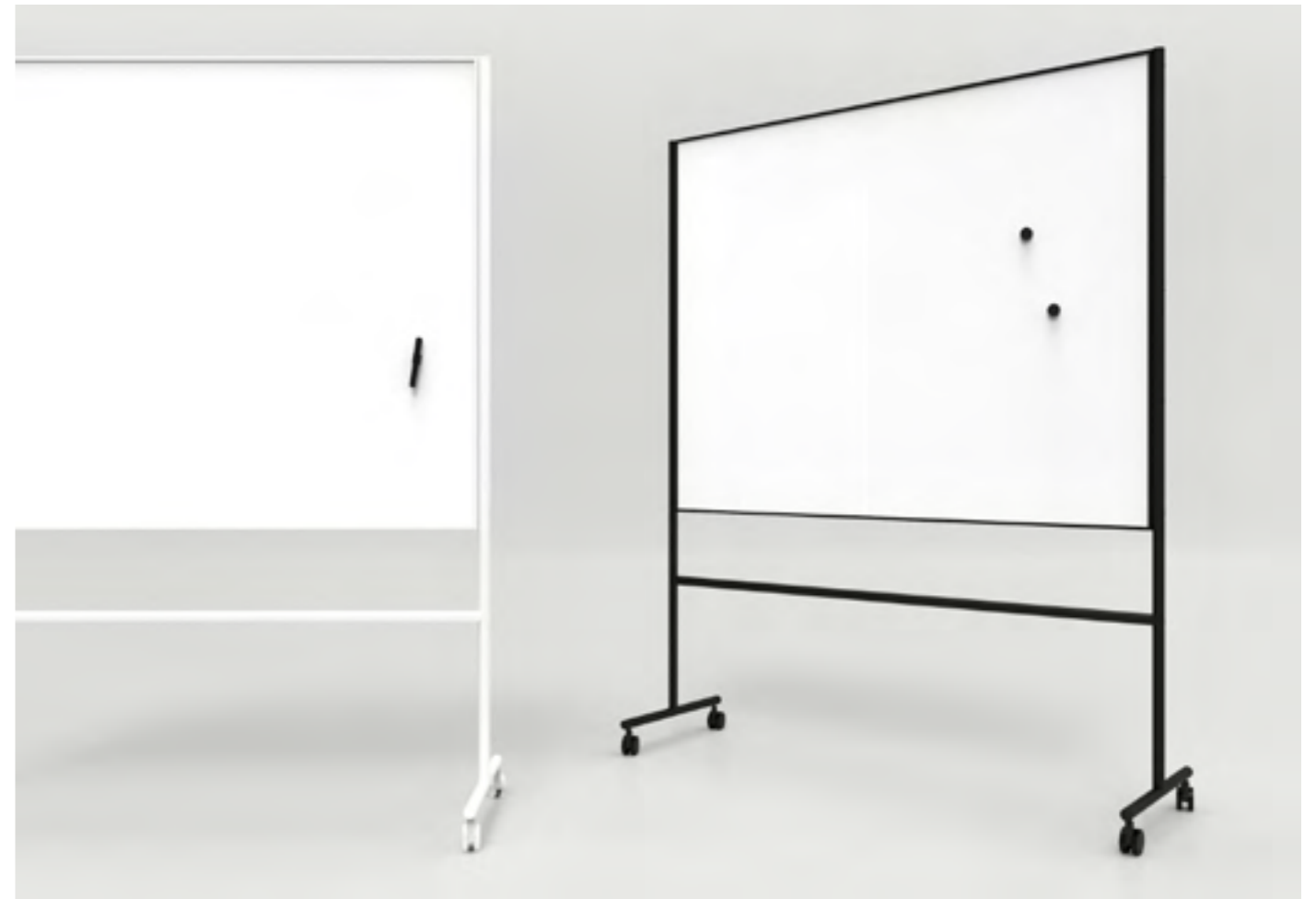

Article number	Name	Size b x h x d mm	Weight kg
91043V	ONE Mobile Whiteboard White double sided	1567 x 1960 x 500 (1507 x 1207)	35
91043S	ONE Mobile Whiteboard Black double sided	1567 x 1960 x 500 (1507 x 1207)	35
91044V	ONE Mobile Whiteboard White double sided	2067 x 1960 x 500 (2007 x 1207)	45
91044S	ONE Mobile Whiteboard Black double sided	2067 x 1960 x 500 (2007 x 1207)	45

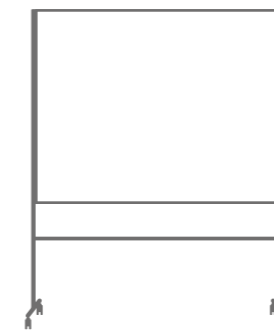

1567 x 1960 x 500

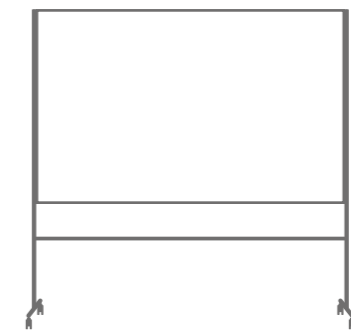

2067 x 1960 x 500



Office Screens

Edge floor screen

A modern floor screen with sound-absorbing properties. Rubber edging in seven colours, adjustable feet in a variety of designs and four types of textile. The screens contains 40 mm recycled polyester that effectively absorbs sound and creates a more harmonious environment. The built-in magnets make the screens easy to connect and move.

Design Christian Halleröd

Built-in magnetic connectors
Price group A, Fiji, Cara and Xpress
Price group B, Blazer Lite
Price group C, Kvadrat Canvas & Remix
7 edging strip colours



Article number	Name	Size w x h mm	Weight kg
Height incl. foot 1350 mm			
75305-edging strip-textile	Floor screen Edge	800 x 1350	10
75306-edging strip-textile	Floor screen Edge	1000 x 1350	11
75307-edging strip-textile	Floor screen Edge	1200 x 1350	11
Height incl. foot 1500 mm			
75300-edging strip-textile	Floor screen Edge	800 x 1500	12
75301-edging strip-textile	Floor screen Edge	1000 x 1500	13
75302-edging strip-textile	Floor screen Edge	1200 x 1500	15
Height incl. foot 1650 mm			
75310-edging strip-textile	Floor screen Edge	800 x 1650	13
75311-edging strip-textile	Floor screen Edge	1000 x 1650	15
75312-edging strip-textile	Floor screen Edge	1200 x 1650	16
Height incl. foot 1800 mm			
75309-edging strip-textile	Floor Screen Edge	800 x 1800	10
75313-edging strip-textile	Floor Screen Edge	1000 x 1800	13
75314-edging strip-textile	Floor Screen Edge	1200 x 1800	16

Edge table screen

A table screen with sound-absorbent properties. Available in a range of different sizes for mounting on the edge or on the top of the desk. The screens contains 30 mm recycled polyester that effectively absorbs sound and creates a more harmonious environment. Rubber edging in seven colours and three types of textile.

Design Christian Halleröd

Price group A, Fiji, Cara and Xpress
Price group B, Blazer Lite
Price group C, Kvadrat Canvas & Remix
7 edging strip colours



Article number	Name	Size w x h mm	Weight kg
Top, height 400 mm			
75320-edging strip-textile	Table screen Edge, top	800 x 400	4
75321-edging strip-textile	Table screen Edge, top	1000 x 400	4
75322-edging strip-textile	Table screen Edge, top	1200 x 400	5
75323-edging strip-textile	Table screen Edge, top	1400 x 400	6
75324-edging strip-textile	Table screen Edge, top	1600 x 400	7
75325-edging strip-textile	Table screen Edge, top	1800 x 400	7
75326-edging strip-textile	Table screen Edge, top	2000 x 400	8
Front, height 700 mm			
75340-edging strip-textile	Table screen Edge, front	800 x 700	5
75341-edging strip-textile	Table screen Edge, front	1000 x 700	6
75342-edging strip-textile	Table screen Edge, front	1200 x 700	7
75343-edging strip-textile	Table screen Edge, front	1400 x 700	8
75344-edging strip-textile	Table screen Edge, front	1600 x 700	9
75345-edging strip-textile	Table screen Edge, front	1800 x 700	10
75346-edging strip-textile	Table screen Edge, front	2000 x 700	11

Edge floor screen

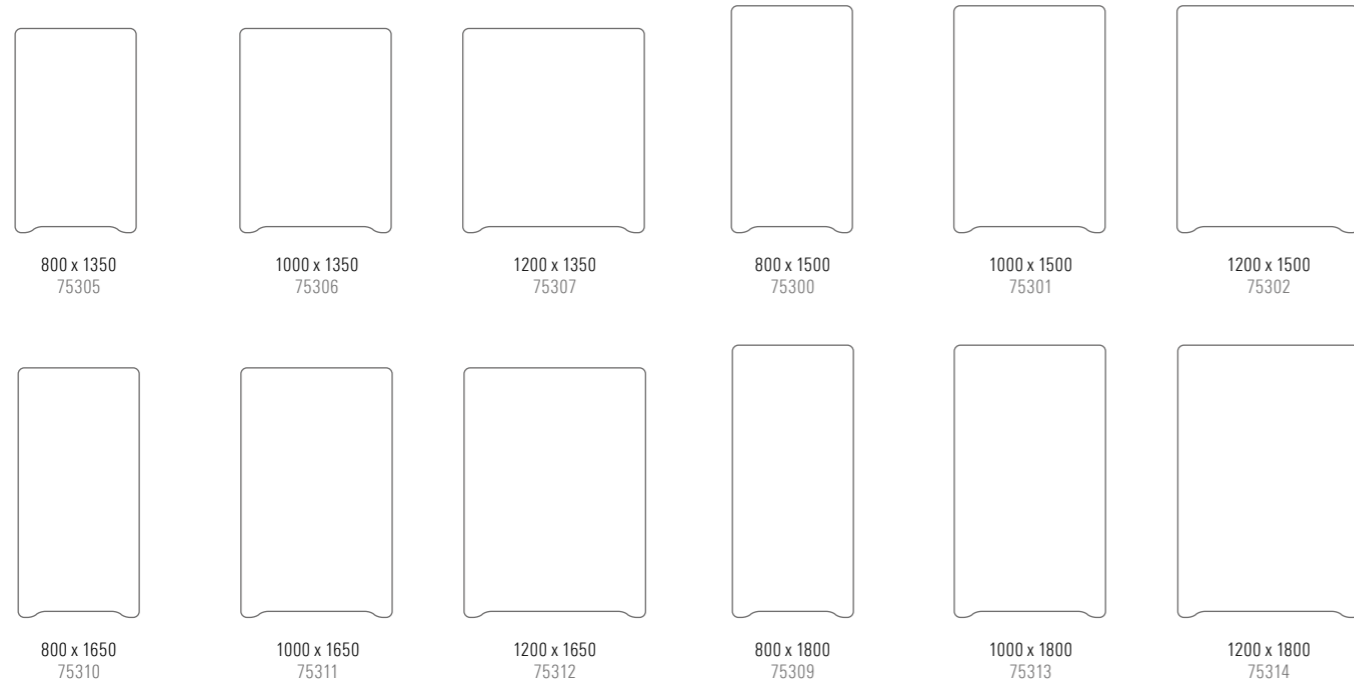

Edge table screen

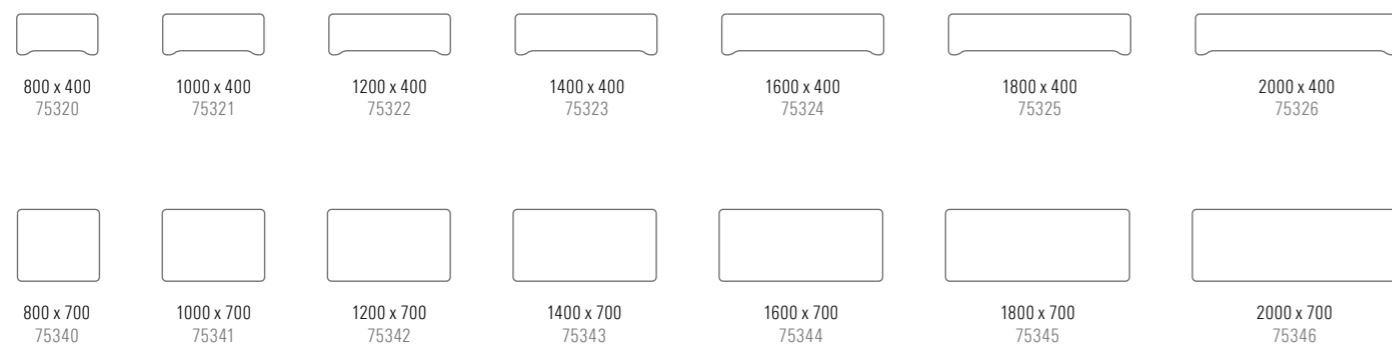

Rubber edging



Fiji Camira, price group A

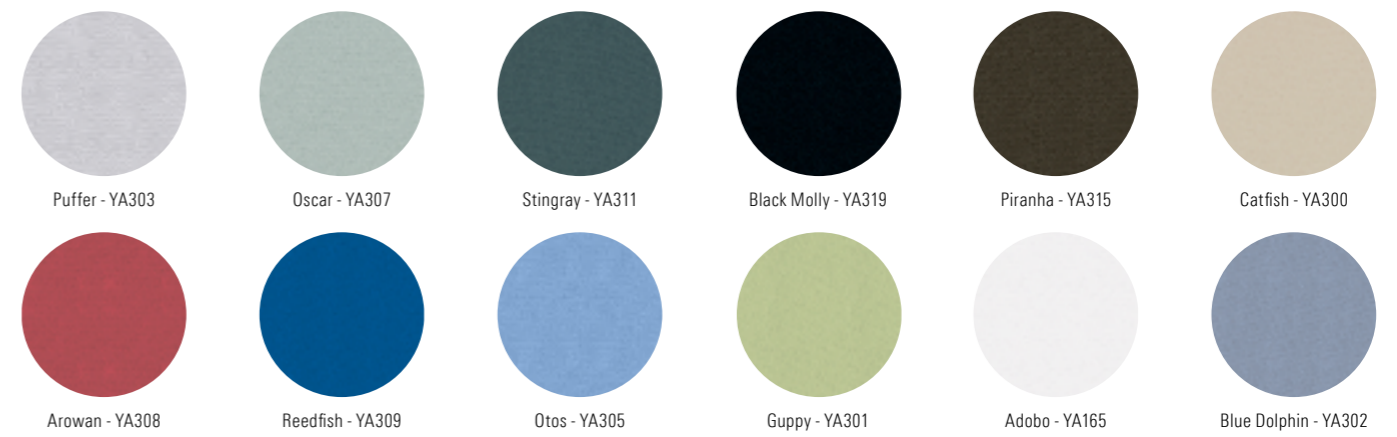

Xpress Gabriel, price group A

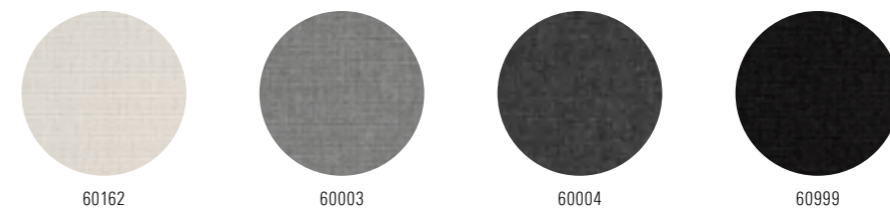

Cara Camira, price group A

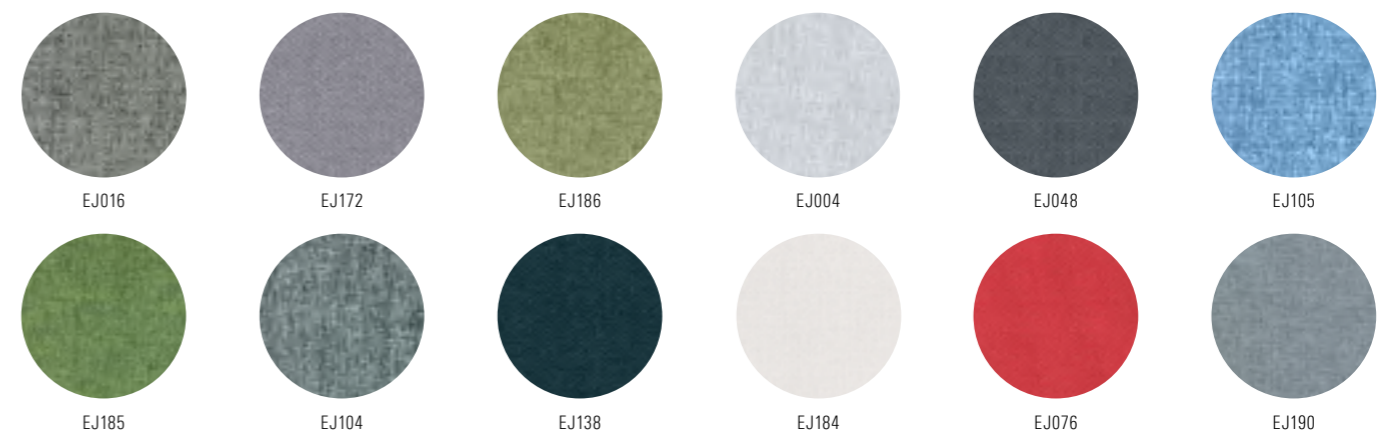

Blazer Lite Camira, price group B

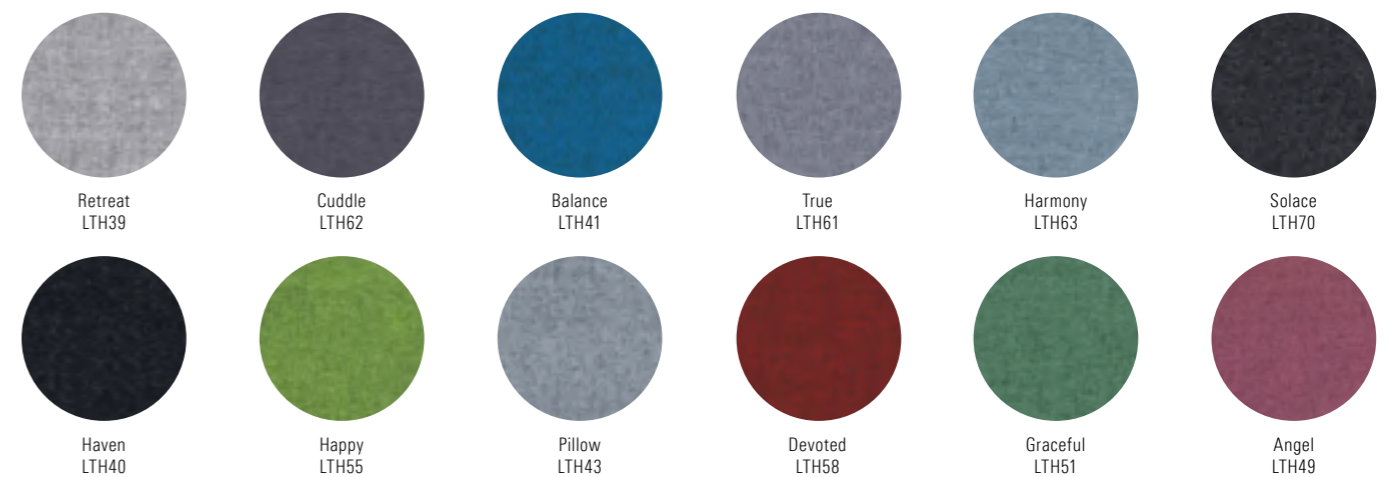

Feet & fittings

Edge feet



T-Fot Blade
Black, 1235S
Grey, 1235G



T-Fot Arc:
Black, 1234S
Grey, 1234G



Round Foot Slim
Black, 1237S
Grey, 1237G



T-foot Blade with castors
Black, 1235S-hjul
Grey, 1235G-hjul

Article number	Name	Size mm	Weight kg
1234S	Arc T-foot, black, adjustable	360	1
1234G	Arc T-foot, grey, adjustable	360	1
1235S	Blade T-foot, black, adjustable	415	1
1235G	Blade T-foot, grey adjustable	415	1
1235S-hjul	Blade T-foot, black, with castors, adjustable	415	1,5
1235G-hjul	Blade T-foot, grey, with castors, adjustable	415	1
1236S	Tube U-foot, black (adds 11cm hight)	315	1
1236G	Tube U-foot, grey (adds 11cm hight)	315	1
1237S	Round foot Slim black, adjustable	Ø 45	1
1237G	Round foot Slim grey, adjustable	Ø 45	1

Edge Connection Brackets floor screen

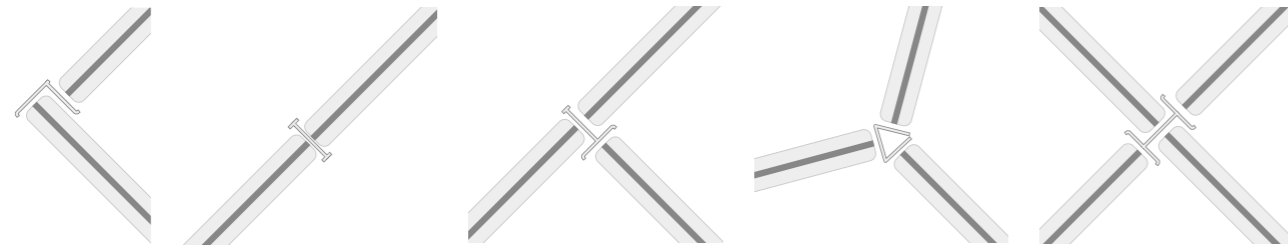

Article number	Name	Weight kg
1268S	Foot fitting connect two screens with one foot	0,5
1268S-L	Foot fitting incl. magnetic top fitting, two screens 90°	0,5
1268S-Y	Foot fitting incl. magnetic top fitting, three screens 120°	0,5
1268S-T	Foot fitting incl. magnetic top fitting, three screens 90°	0,5
1268S-X	Foot fitting incl. magnetic top fitting, four screens 90°	0,5

Table brackets & accessories

Edge table brackets



Table bracket Ease, top



Table bracket Ease, top

Article number	Name	
75420S-T	Table bracket Ease, top, black, pair	Tabletop thickness 16-35mm
75420G-T	Table bracket Ease, top, grey, pair	Tabletop thickness 16-35mm
75420S-F	Table bracket Ease, front, black, pair	Tabletop thickness 16-35mm
75420G-F	Table bracket Ease, front, grey, pair	Tabletop thickness 16-35mm
75400-FOT	T-foot Edge , stand alone , desk screen, pair	
75412-DOLD	L-Bracket, front, pcs	

Edge accessories

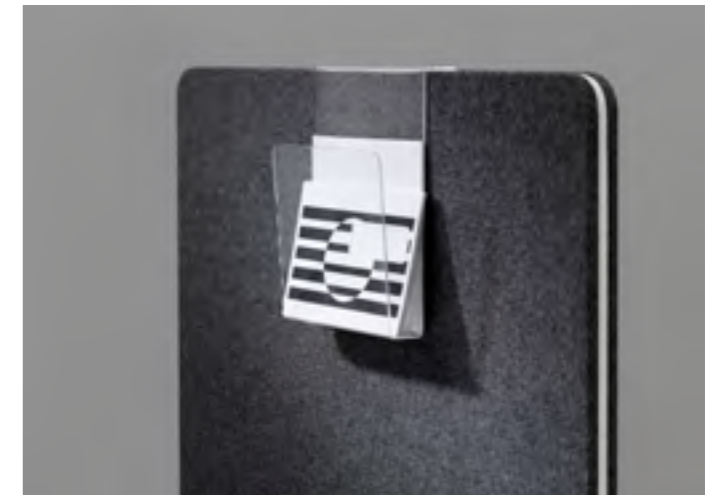

Article number	Name	Size w x h mm	Weight kg
1582	Edge Floor Plexi Hook		0,1
1584	Edge Floor Plexi Mug		0,1
1586	Edge Floor Plexi Paper holder		0,1
1588-colour code	Edge Floor Plexi Mood	300 x 300	1,5
1589-colour code	Edge Floor Plexi Mood	500 x 500	3,5
1581	Edge Table Plexi Hook		0,1
1583	Edge Table Plexi Mug		0,1
1585	Edge Table Plexi Paper holder		0,1
1587-colour code	Edge Table Plexi Mood	300 x 300	1,4

Mood Fabric Table

Table screen with a magnetic glass writing surface combined with a fabric covered, sound-absorbent back. Mood fabric is a versatile screen that offers a seamless combination of functions and materials. Available in a range of different sizes with fittings for fixed mounting or a combined stand and pen holder for free placement on a table. All screens have a sound absorbing 37 mm polyester filling. Choose from 8 selected colour combinations.

Design Christian Halleröd & Matti Klenell

Tempered, low iron glass
8 selected colour combination
Magnetic writing surface
37 mm sound absorbent-filling

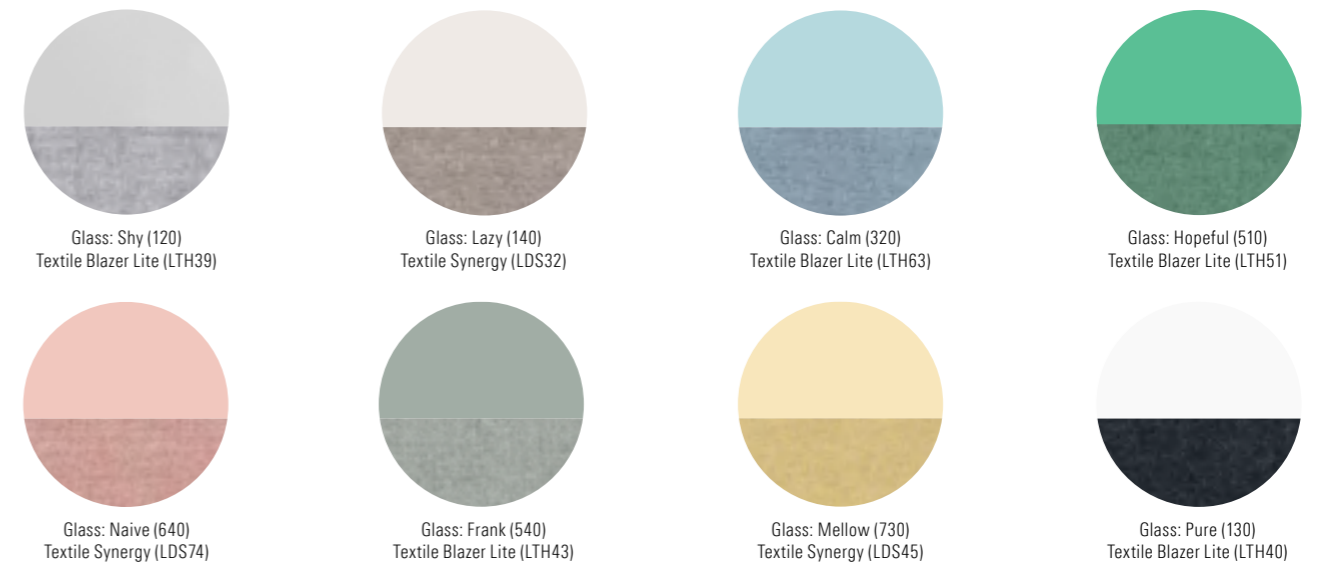
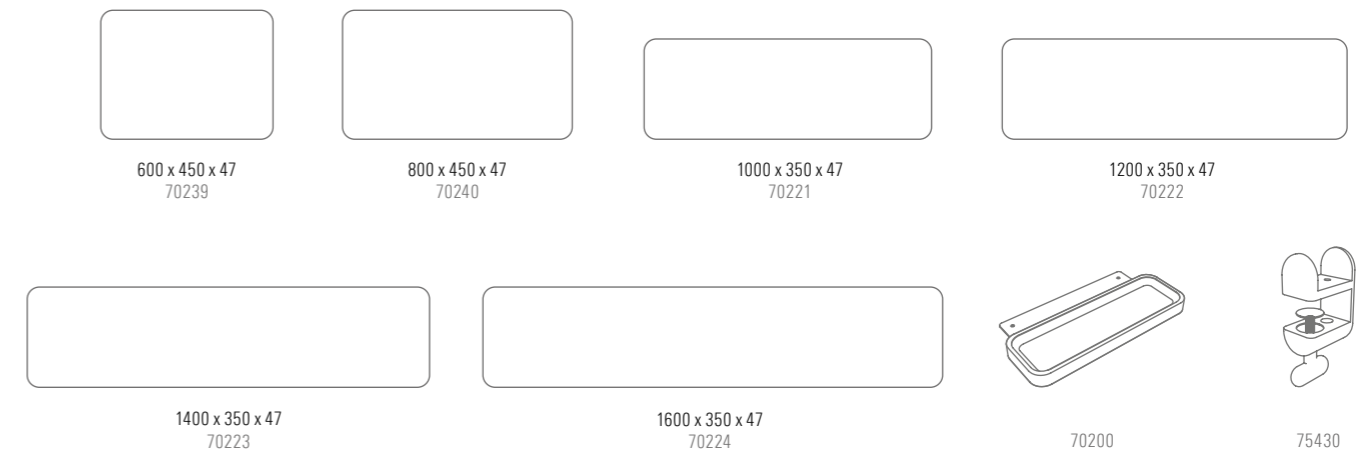

Article number	Name	Size w x h x d mm	Weight kg
70221-textile-glass	Mood Fabric Table	1000 x 350 x 47	11
70222-textile-glass	Mood Fabric Table	1200 x 350 x 47	12
70223-textile-glass	Mood Fabric Table	1400 x 350 x 47	14
70224-textile-glass	Mood Fabric Table	1600 x 350 x 47	16
70239-textile-glass	Mood Fabric Table	600 x 450 x 47	10
70240-textile-glass	Mood Fabric Table	800 x 450 x 47	11
75430-G	Mood Fabric table bracket, grey, pair		0,3
75430-S	Mood Fabric table bracket, black, pair		0,3
70200	Table stand for free standing screen, birch, pair		1

ONE Screen

Three-panel mobile screen with a black or white frame. The fibreboard panels are covered in fabric, ideal for pinning papers to. Available as a triple or a single screen.

3 colours, textile
Frame, Black/White
Triple or single



Article number	Name	Size w x h mm	Weight kg
95501S-B	ONE Screen single, black	770 x 1705	11
95501S-DG	ONE Screen single, dark grey	770 x 1705	11
95501S-G	ONE Screen single, grey	770 x 1705	11
95503S-B	ONE Screen triple, black	2280 x 1705	28
95503S-DG	ONE Screen triple, dark grey	2280 x 1705	28
95503S-G	ONE Screen triple, grey	2280 x 1705	28

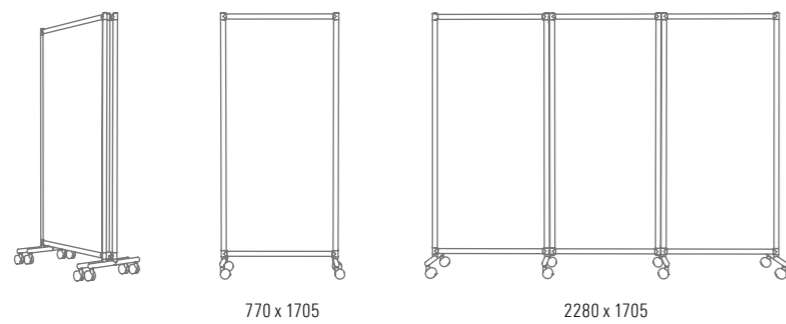



Notice Boards & Sound Absorbers

Edge Wall sound absorber

A wall mounted sound absorber filled with 50 mm recycled polyester for best possible sound absorption. The Edge Wall has straight corners, concealed fitting and is available in four different types of textile.

Depth from wall 52 mm
 7 sizes
 Concealed fittings
 Price group A, Fiji, Cara and Xpress
 Price group B, Blazer Lite

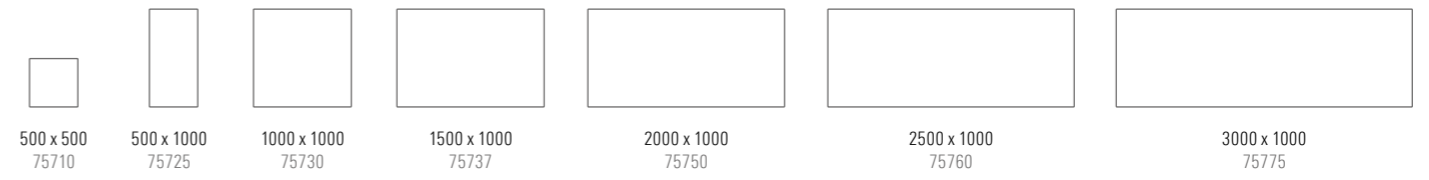

Blazer Lite Camira

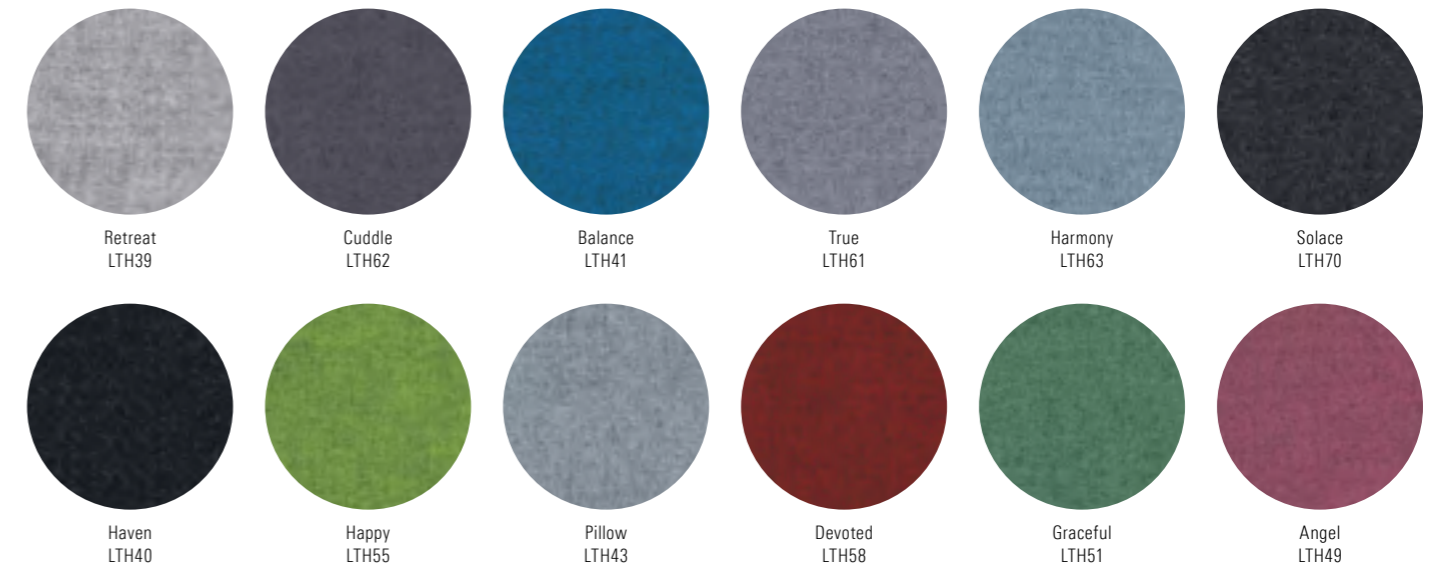

Article number	Name	Size w x h x d mm	Weight kg
75710-colour code	Edge Wall sound absorber	500 x 500 x 50	2
75725-colour code	Edge Wall sound absorber	500 x 1000 x 50	4
75730-colour code	Edge Wall sound absorber	1000 x 1000 x 50	8
75737-colour code	Edge Wall sound absorber	1500 x 1000 x 50	12
75750-colour code	Edge Wall sound absorber	2000 x 1000 x 50	15
75760-colour code	Edge Wall sound absorber	2500 x 1000 x 50	19
75775-colour code	Edge Wall sound absorber	3000 x 1000 x 50	23

Colour chart on page 86

Bloc sound absorber

This sound absorber has softly rounded corners and a 48mm sound absorbing filling. Can be placed by itself, in larger groups or together with other members of the Bloc series, which also include sound absorbers, newsstands and glass writing boards.

Design Christian Halleröd & Matti Klenell

Thickness 50 mm
 Concealed fittings
 48 mm sound absorbent-filling
 Textile Blazer Lite

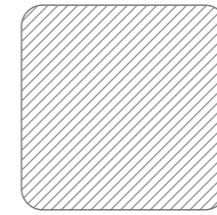

Sound absorber, textile
 600 x 600 x 50
 70806-textile

Blazer Lite Camira

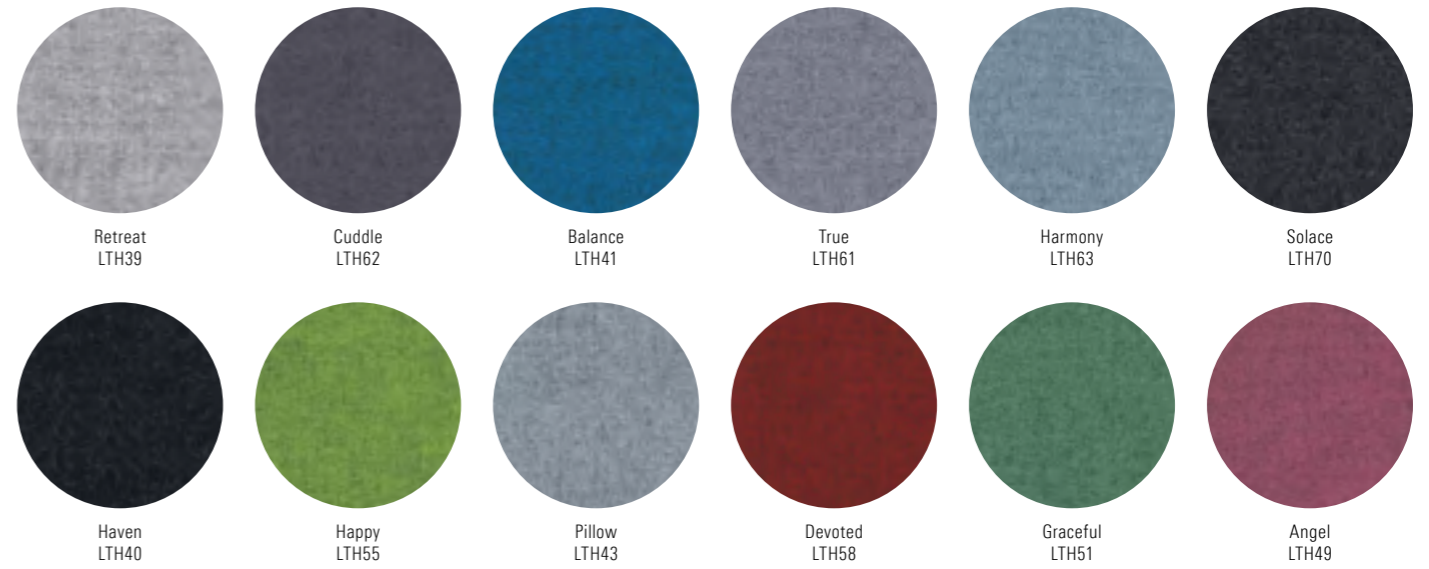

Article number	Name	Size w x h x d mm	Weight kg
70806-colour code	Bloc Textile	600 x 600 x 50	3

Bloc noticeboard

A softly rounded noticeboard made from solid, highest quality, cork. Can be placed by itself, in larger groups or together with other members of the Bloc series, which also include sound absorbers, newsstands and glass writing boards.

Design Christian Halleröd & Matti Klenell

Thickness 50 mm
 Concealed fittings
 Solid high quality cork



Article number	Name	Size w x h x d mm	Weight kg
70806-C	Bloc Cork	600 x 600 x 50	9

Air Cork noticeboard

A cork notice board with with bevelled white edges instead of a traditional frame. This, in combination with concealed fittings, gives the board a sense of floating on the wall.

Depth from wall 22 mm
 Concealed fittings



Article number	Name	Size w x h mm	Weight kg
27823K-AIR	Air Cork	590 x 890 x 16	6
27826K-AIR	Air Cork	990 x 1190 x 16	12
27827K-AIR	Air Cork	1490 x 1190 x 16	18
27828K-AIR	Air Cork	1990 x 1190 x 16	24

Air Bulletin noticeboard

This frameless notice board in Bulletin Board material has bevelled edges and concealed fittings, giving it a sense of floating on the wall. The material is self-healing to keep the board looking smarter for longer. The Air Bulletin Board is available in 8 sizes and 15 colours.

Depth from wall 22 mm
15 colours
Concealed fittings

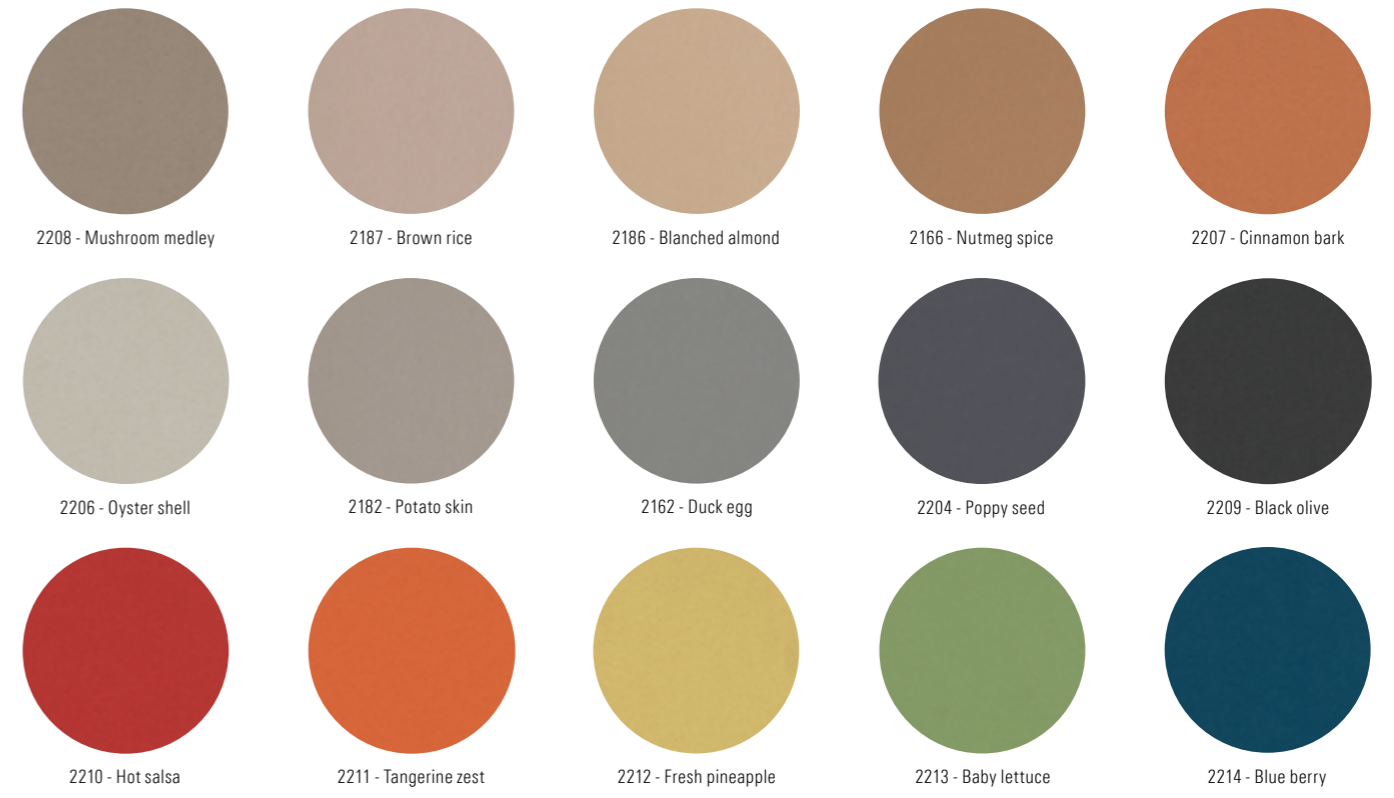

Article number	Name	Size w x h mm	Weight kg
27822BM	Bulletin Board, Air	445 x 595	3
27823BM	Bulletin Board, Air	595 x 895	7
27824BM	Bulletin Board, Air	895 x 1195	14
27826BM	Bulletin Board, Air	995 x 1195	15
27827BM	Bulletin Board, Air	1495 x 1195	23
27828BM	Bulletin Board, Air	1995 x 1195	30
27829BM	Bulletin Board, Air	2495 x 1195	38
27830BM	Bulletin Board, Air	2995 x 1195	45

Textile notice board

A classic textile notice board with folded textile edges and concealed fittings. Choose between Cara, Fiji, Xpress and Blazer Lite.

Concealed fittings
Depth from wall 20 mm
Price group A, Fiji, Cara and Xpress
Price group B, Blazer Lite



Article number	Name	Size w x h mm	Weight kg
278260MV-color code	Notice board textile	1005 x 1205	8
278270MV-color code	Notice board textile	1505 x 1205	12
278280MV-color code	Notice board textile	2005 x 1205	15
278290MV-color code	Notice board textile	2505 x 1205	19
278300MV-color code	Notice board textile	3005 x 1205	23

Colour chart on page 86

Boarder Bulletin noticeboard

Notice board in Bulletin Board material with natural or white anodised aluminium frame. The material is self-healing to keep the board looking smarter for longer. Available in seven sizes and a wide range of colours.

Depth from wall 19 mm
15 colours
Concealed fittings



Article number	Name	Size w x h mm	Weight kg
27822B	Bulletin Board, aluminium frame	455 x 605	3
27823B	Bulletin Board, aluminium frame	605 x 905	6
27824B	Bulletin Board, aluminium frame	905 x 1205	11
27826B	Bulletin Board, aluminium frame	1005 x 1205	12
27827B	Bulletin Board, aluminium frame	1505 x 1205	18
27828B	Bulletin Board, aluminium frame	2005 x 1205	24
27829B	Bulletin Board, aluminium frame	2505 x 1205	30
27830B	Bulletin Board, aluminium frame	3005 x 1205	36
28822B	Bulletin Board, white aluminium frame	455 x 605	3
28823B	Bulletin Board, white aluminium frame	605 x 905	6
28824B	Bulletin Board, white aluminium frame	905 x 1205	11
28826B	Bulletin Board, white aluminium frame	1005 x 1205	12
28827B	Bulletin Board, white aluminium frame	1505 x 1205	18
28828B	Bulletin Board, white aluminium frame	2005 x 1205	24
28829B	Bulletin Board, white aluminium frame	2505 x 1205	30
28830B	Bulletin Board, white aluminium frame	3005 x 1205	36

Colour chart on page 90

Boarder Textile noticeboard

Classic textile notice board with natural or white anodised aluminium frame. Choose between plastic or mitred corners. The standard fabrics are Fiji, Cara or Xpress.

Depth from wall 19 mm
Concealed fittings



Article number	Name	Size w x h mm	Weight kg
27822TYG	Notice board textile, aluminium frame	455 x 605	2
27823TYG	Notice board textile, aluminium frame	605 x 905	4
27824TYG	Notice board textile, aluminium frame	905 x 1205	7
27826TYG	Notice board textile, aluminium frame	1005 x 1205	8
27827TYG	Notice board textile, aluminium frame	1505 x 1205	12
27828TYG	Notice board textile, aluminium frame	2005 x 1205	15
27829TYG	Notice board textile, aluminium frame	2505 x 1205	19
27830TYG	Notice board textile, aluminium frame	3005 x 1205	23
27822GT	Notice board textile, mitred corners, aluminium frame	455 x 605	2
27823GT	Notice board textile, mitred corners, aluminium frame	605 x 905	4
27824GT	Notice board textile, mitred corners, aluminium frame	905 x 1205	7
27826GT	Notice board textile, mitred corners, aluminium frame	1005 x 1205	8
27827GT	Notice board textile, mitred corners, aluminium frame	1505 x 1205	12
27828GT	Notice board textile, mitred corners, aluminium frame	2005 x 1205	15
27829GT	Notice board textile, mitred corners, aluminium frame	2505 x 1205	19
27830GT	Notice board textile, mitred corners, aluminium frame	3005 x 1205	23

Colour chart on page 87

Boarder linen/cork

Classic linen/cork covered notice board. Natural or white anodised aluminium frame. Choose between plastic or mitred corners.

Concealed fittings
Depth from wall 19 mm



Article number	Name	Size w x h mm	Weight kg
27822L	Notice board linen, aluminium frame	455 x 605	2
27823L	Notice board linen, aluminium frame	605 x 905	4
27824L	Notice board linen, aluminium frame	905 x 1205	7
27826L	Notice board linen, aluminium frame	1005 x 1205	8
27827L	Notice board linen, aluminium frame	1505 x 1205	12
27828L	Notice board linen, aluminium frame	2005 x 1205	15
27829L	Notice board linen, aluminium frame	2505 x 1205	19
27830L	Notice board linen, aluminium frame	3005 x 1205	23
27822K	Notice board cork, aluminium frame	455 x 605	2
27823K	Notice board cork, aluminium frame	605 x 905	4
27824K	Notice board cork, aluminium frame	905 x 1205	7
27826K	Notice board cork, aluminium frame	1005 x 1205	8
27827K	Notice board cork, aluminium frame	1505 x 1205	12
27828K	Notice board cork, aluminium frame	2005 x 1205	15
27829K	Notice board cork, aluminium frame	2505 x 1205	19
27830K	Notice board cork, aluminium frame	3005 x 1205	23

Blazer Lite Camira

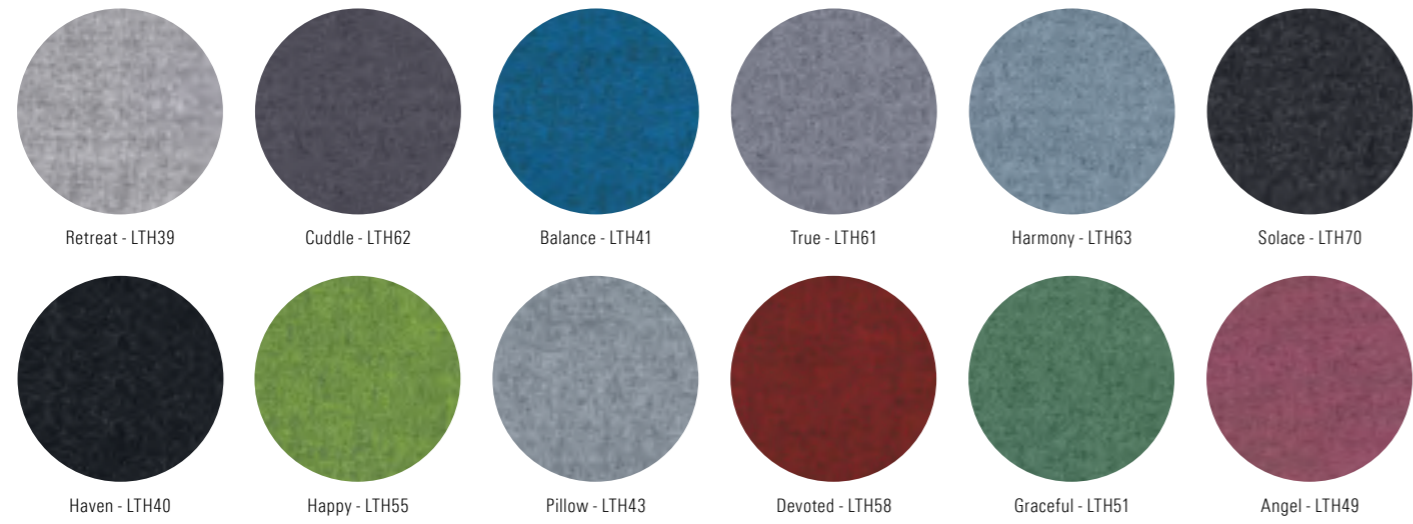

Blazer Lite, non stock colours

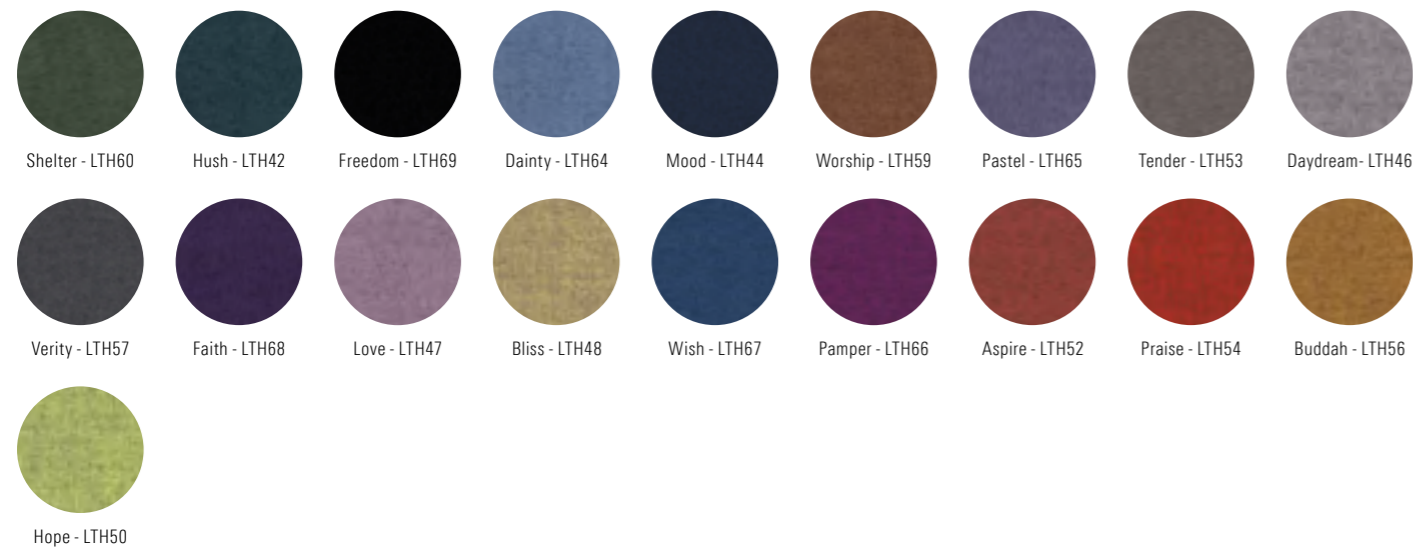

Fiji Camira

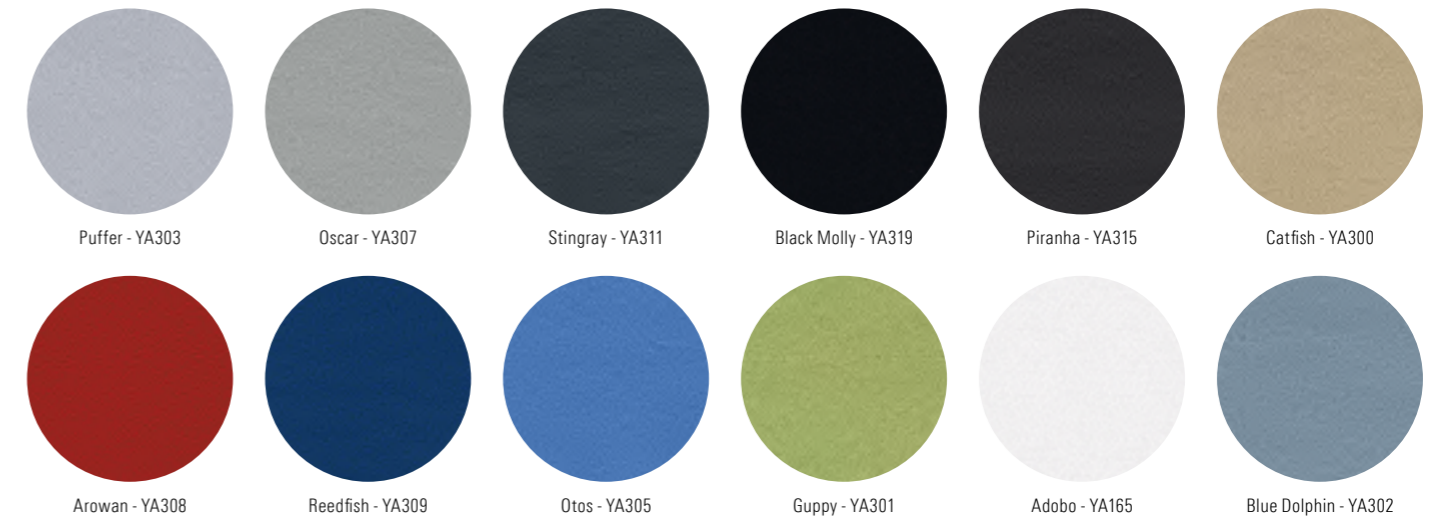

Fiji, non stock colours



Cara Camira

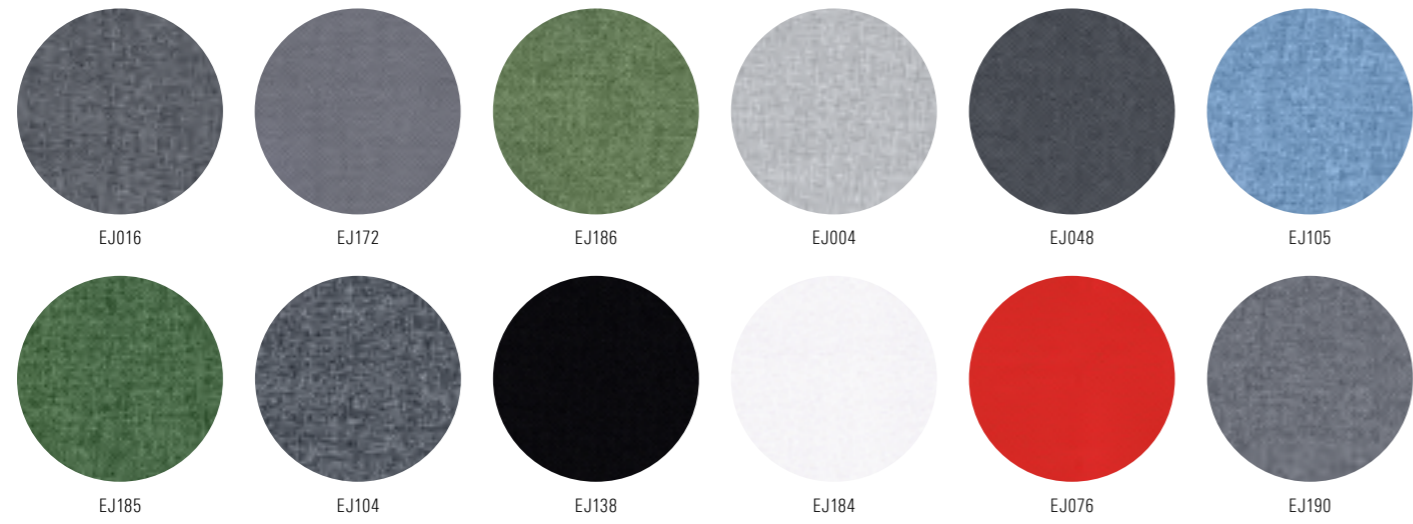

Cara, non stock colours

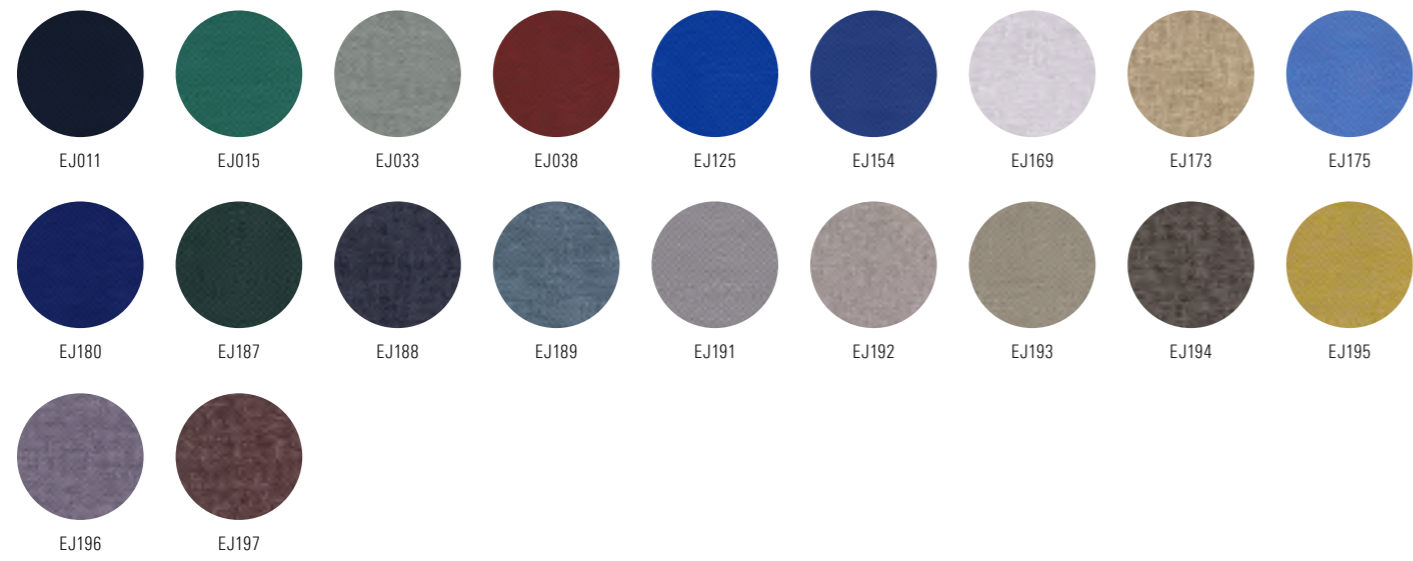

Xpress Gabriel

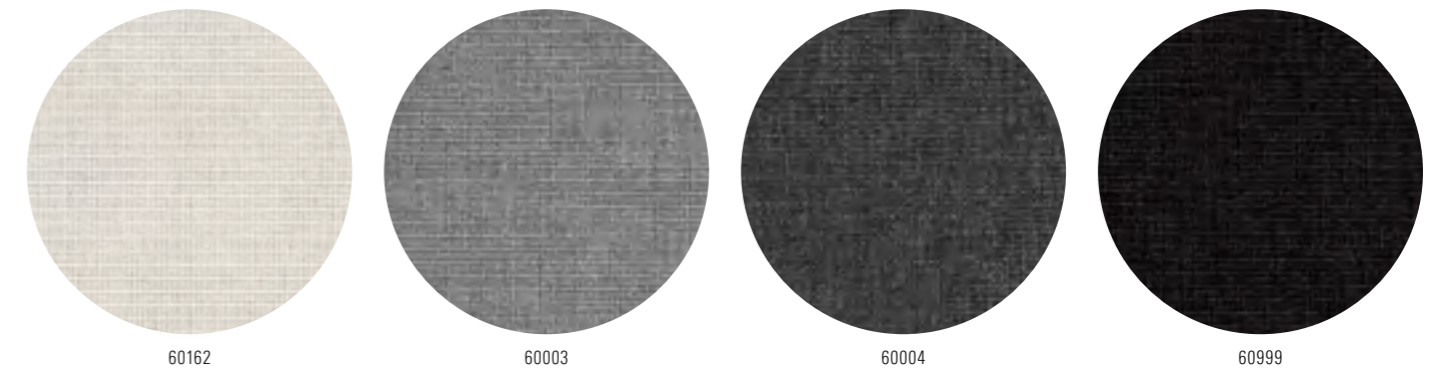

Xpress, non stock colours

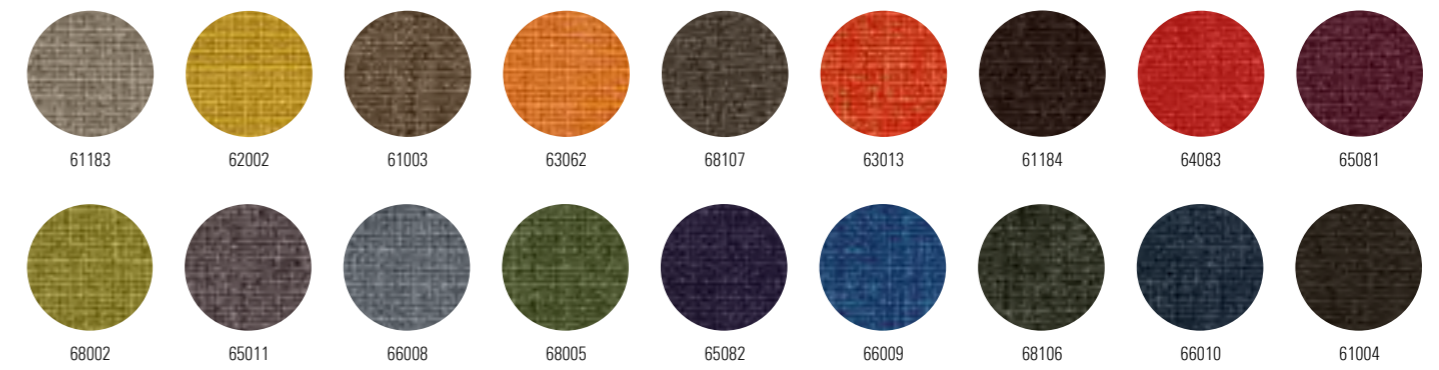

Bulletin Board

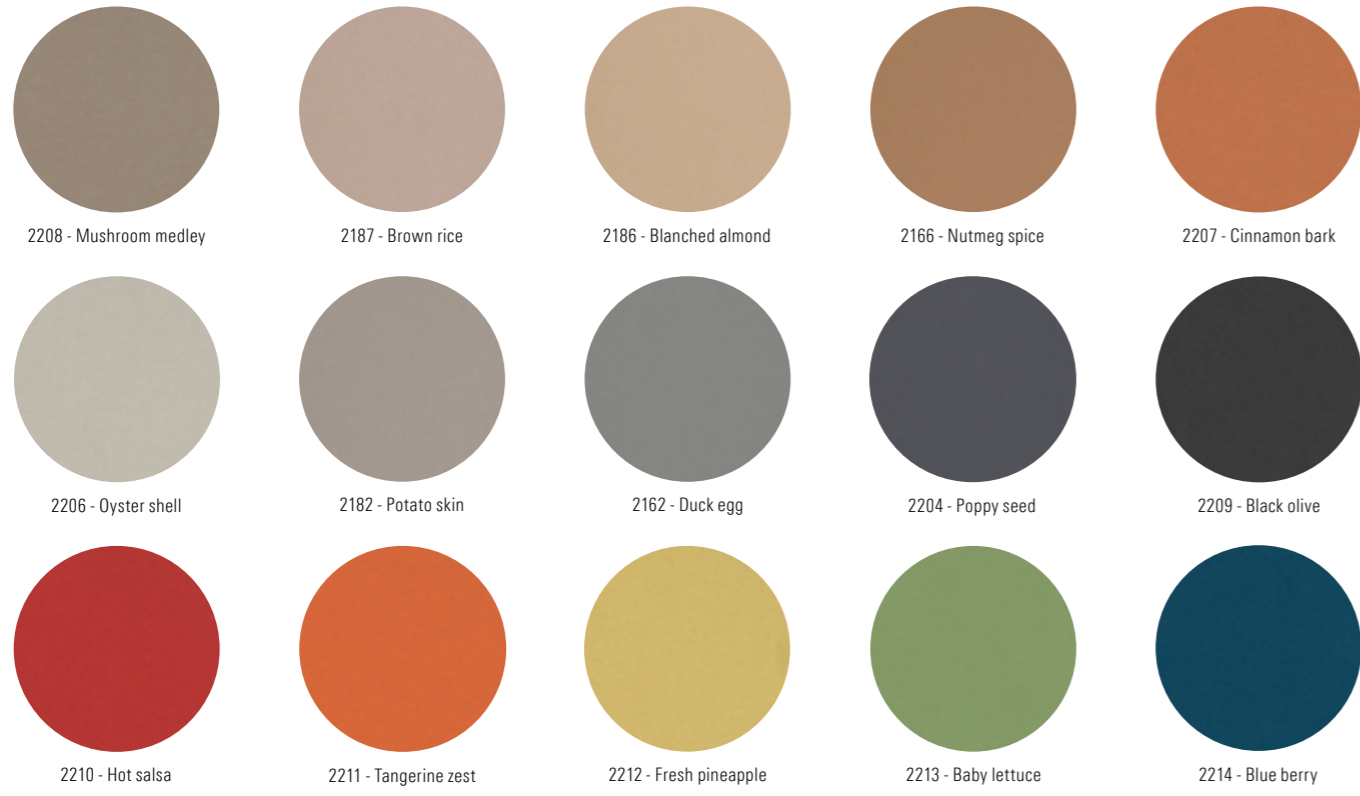

Mood

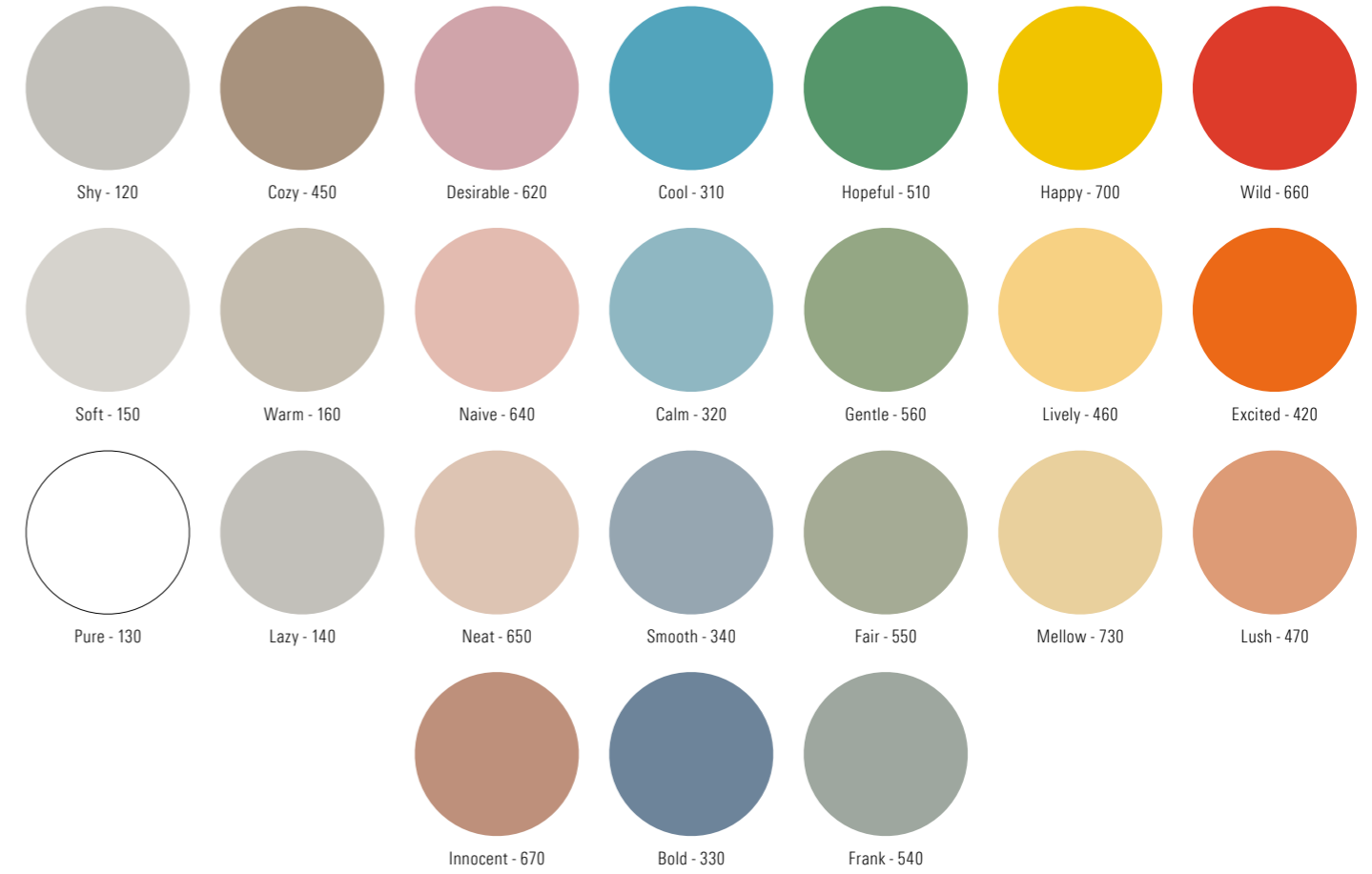

Sales and delivery terms**UK, Benelux, Germany, Austria, France, Baltic Countries, Poland:**

Free delivery DAP on orders above €1000 Net.
For orders less €1000 a freight cost of €100 is charged.

Switzerland, Spain, Italy, Ireland:

Free delivery DAP on orders above €1500 Net
For orders less €1500 a freight cost of €200 is charged

Other contries:

Ex Works or according to agreement.

Reservation regarding ownership

Deliveries will only be effected at our terms of payment and delivery. The goods remain the property of Lintex until full payment has been settled

Delivery times

Goods in stock: normally 5 - 8 working days. For other products, inquire about delivery time. Delivery time is reckoned from the day we receive the order. Our confirmed shipping day is the day the goods leave the plant.

Quote

Unless otherwise stated a quote applies for 60 days. Orders are accepted as and when confirmed in writing by Lintex.

Returned goods

Standard products that Lintex keeps in stock may be returned within 14 days of delivery. The customer is responsible for paying the return shipping cost and the goods must be returned in their unbroken original packaging. Any damage in transit will be charged to the customer. Before the return, Lintex's sales department must be contacted to obtain a returns note. Lintex will charge the customer a returns fee of 20% of the value of the goods. An order may be cancelled within three working days of the order confirmation. There will be no refund for the cancellation of manufactured products that are not stock items.

Claims

If upon arrival the product is damaged, this shall be noted in the consignment note before receipt is acknowledged. Damage claims shall be notified to the responsible shipping agent. Claims can also be filed 7 days after receipt if the damage was not discovered upon arrival. Other claims due to obvious shortcomings on our part shall be submitted in writing to Lintex.

Payment terms

30 days net. In case of delayed payment, late charges will be debited corresponding to 8 per cent interest above the reference interest rate of the Swedish Central Bank.

Conditional sale

Delivered goods remain the property of Lintex until full payment has been made.

Prices

We reserve the right to raise prices due to rises in raw material prices and currency fluctuations. Articles can also be the subject of constructional and design changes. All prices are exclusive of sales tax.

Guarantee duration

Lintex provides 2 years guarantee against defects in manufacture. The guarantee period is reckoned from delivery day and assumes that directly after delivery the products are placed in premises at room temperature and that they are not exposed to abnormal wear or damaging treatment. When mounting or assembling in situ by a fitter recommended by Lintex, 2 years guarantee is given from the date of approved inspection.

Contact**Sverige - Lintex AB**

Madesjövägen 17
382 45 Nybro

Showroom:
Nybro, Madesjövägen 17
Stockholm, Rosenlundsgatan 40
Göteborg, Maskingatan 5

Tel: +46 481 799 000
Fax: +46 481 799 010

info@lintex.se
order@lintex.se
www.lintex.se

Deutschland - Lintex GMBH

Fasanenstraße 45
10719 Berlin

Showroom:
Fasanenstraße 45
10719 Berlin

SBS Showroom/ co. Lintex
Kaistrasse 6
D-40221 Düsseldorf

Designerwerschau
Fruchthof München
2. Innenhof, 2. Etage
Gotzinger Straße 52b
D-81371 München

info.de@lintex.org
www.lintex.org

Norge - Osnes AS

Musmyrveien 4
3520 Jevnaker

Showroom:
Oslo, Stålfjæra 9

Tel: +47 613 149 99
Fax: +47 613 129 69

firmapost@osnes.no
www.osnes.no

Danmark - Lintex A/S

Mandal Allé 3
5500 Middelfart

Showroom:
København, Carl Jacobsen vej 16
Middelfart, Mandal Allé 3
Aarhus, Søren Frichs Vej 38B

Tel: +45 702 215 17

info@lintex.as
www.lintex.as

France

Jean-David Pottier/Jerome Pecnard
21 Avenue des Marronniers
94130 Nogent-sur-Marne

+33 664 29 04 64

jdottier@wanadoo.fr

Soumi - Lintex Oy

Kalkkitie 2
24280 Salo

Showroom:
Helsinki, Vuorimiehenkatu 2
Salo, Raitalankatu 14

Tel: +358 272 712 20
Fax: +358 272 712 33

info@lintex.fi
www.lintex.fi

UK - Lintex UK Ltd

104-105 Saffron Hill
London EC1N 8HB

Showroom:
104-105 Saffron Hill
London EC1N 8HB

info.uk@lintex.org
www.lintex.org

Agents

Austria

Frost International
Rudolfplatz 13a
A 1010 Wien
+43 699 15 05 50 06
s.bleil@frost-international.at
www.frost-international.at

Switzerland

Alain Venzin
Rue Beauregard 18
CH-2520 La Neuveville
+41 79 635 62 89
+41 32 751 56 50
venzin-alain@hotmail.com

Belgium

Eurodesign Collections
Ambachtsweg 25B
9820 Merelbeke
+32 477 29 05 04
carl@eurodesign.be
www.eurodesign.be

Germany 7-9

Project:m3
Kapellånger 16
82281 Egenhofen bei München
+49 171 772 2217
s.julier@projekt-m3.de
www.projekt-m3.de

Spain

Ege Marco Mobiliario Internacional
c/ Hermosillo, 70 Entreplanta
28001 Madrid
+34 914 351 927
marco@marcogil.com
www.marcogil.com

France

Jean-David Pottier/Jerome Pecnard
21 Avenue des Marronniers
94130 Nogent-sur-Marne
+33 664 29 04 64
jdpottier@wanadoo.fr

Netherlands

Onstein Textiel Agenturen
Singel 17
1261 XP Blaricum
+31 35 6237337
gijs.onstein@onstein-textiel.nl
www.onstein-textiel.nl

Italy

SITMATIC ITALIA SRL
Via R. Luxemburg, 1
42010 Rio Saliceto RE – IT
+39 0522 1753116
info@sitmatic.eu
http://www.sitmaticitalia.eu

Portugal

Pedro Cruz Representações
Rau das Taipas, 34 1º Frt.
1250-266 Lisbon
+351 916 182 218
pedrocruz.representacoes@gmail.com

Croatia

ADDE STUDIO d.o.o.
Karasicka 22a
10000 ZAGREB
+385 (0)1 615 55 50
studio@adde.hr
http://www.adde.hr