

VITAWORK®

# VITAWORK® THE BEST LIGHT FOR WORKPLACES.

## **Designed to suit every room setting.**

With its focus on the quality of the light, the appearance has deliberately done away with superfluous elements. The clean lines fit perfectly into interiors of every style and give them added value. All materials used underline the high quality standard and can be recycled.

In addition to a broad range of standard products, customised products for specific projects are also available.







## Even lighting for rooms of every size.

VITAWORK® is available with three different luminous flux intensities which can light rooms of different size. The colour temperature of 4,000 K with a colour rendering index of CRI > 80 provides optimal working light. The combination of direct and indirect lighting via the built-in light panel provides particularly even illumination.

A variant with biologically effective lighting (2,700–6,500 K) will complete the product range.

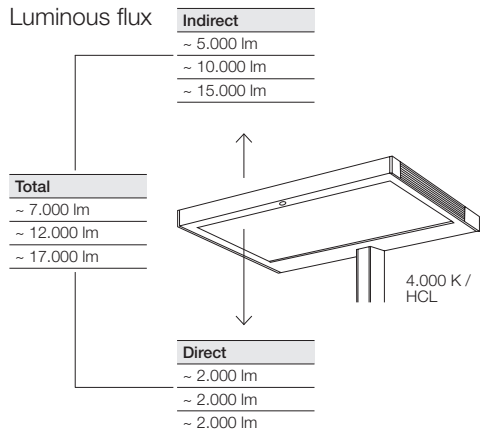

State-of-the-art LEDs provide either symmetrical or asymmetrical light distribution via a light panel. VITAWORK® is suitable for complete illumination of larger and more spacious offices. In the development of this range, we have placed special emphasis on energy efficiency (approx. 135 lm/W). Depending on the application, VITAWORK® fulfils the requirements of the EN 12464-1 standard and the German workplace ordinance ASR 3.4.

EN 12464-1

ASR 3.4

## Asymmetrical Light Distribution

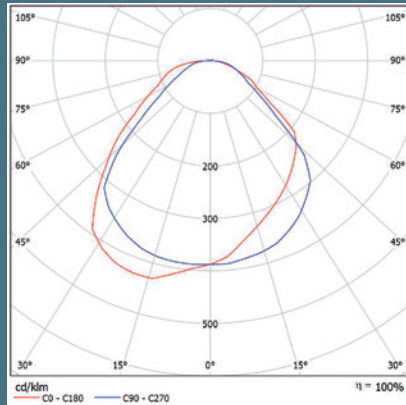
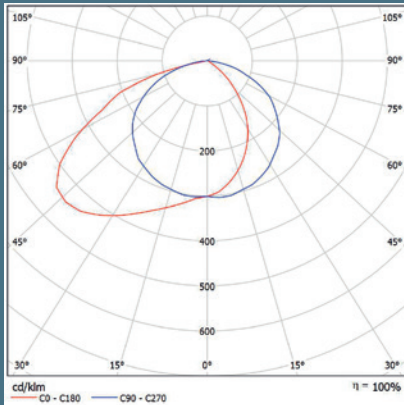

All lamps are also available with symmetrical light distribution.





# OPERATION AND SENSORS

**Sophisticated technology that's easy to operate.**

At the core of all LUCTRA® lamps is the patented VITACORE® electronic system. It provides the best quality of light, and its operation is child's play.

VITAWORK® comes with a pleasantly unobtrusive touch panel. In addition to the on/off function, separate stepless dimming of both the direct and indirect light is possible. If desired, the floor lamp can also be controlled via a presence or light intensity sensor.

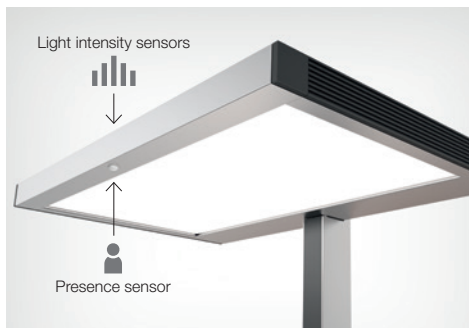





# VITAWORK® CAN BE CUSTOMISED TO YOUR PROJECT

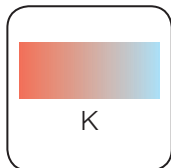

Biological  
lighting effect/  
project-specific  
colour  
temperature

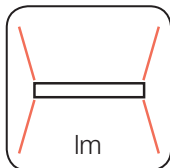

Customised  
luminous flux/  
adjustable  
lighting  
sequence curve

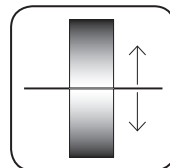

Joint direct/  
indirect  
dimming

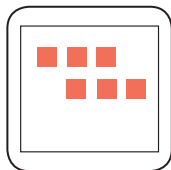

Light networking/  
integration into  
building

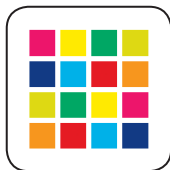

Your choice of  
colour

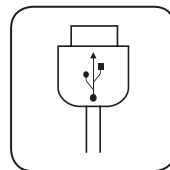

USB charging  
ports

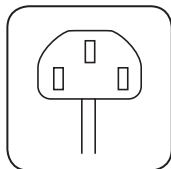

Kettle  
plug

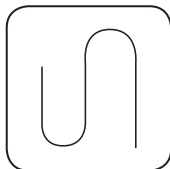

Customised  
cable length and  
easy exchange of  
cables



Made in  
Germany

# ABOUT LUCTRA®

LUCTRA® has set out to provide the best possible light for working: innovative, inspiring, reliable, sustainable. Light which not only illuminates, but also makes its users more contented, less tired and perhaps even a little more successful. This works because it gives the right impulses for every situation, perfectly in line with the user's taste.

The biological effect of LUCTRA® light was proven in a clinical study.

VITAWORK® is a logical continuation of the LUCTRA® philosophy, bringing the latest LED technology, total flexibility and functional design to the workplace. Available for delivery from summer 2018.

All LUCTRA® lamps are developed and assembled manually in Germany. See **[www.luctra.eu](http://www.luctra.eu)** for further details about our project support, other products and our team.

LUCTRA® is a brand of DURABLE

DURABLE · Hunke & Jochheim GmbH & Co. KG

Westfalenstraße 77–79 · 58636 Iserlohn

P.O. Box 1753 · 58634 Iserlohn · Germany

Phone +49 23 71 6624 45

info@luctra.eu · www.luctra.eu