

TECHNICAL SPECIFICATION

COLOURS

WORKTOP, TOP, BOTTOM



14 BEECH



26 ALUMINUM SATINATO



31 CANADIAN OAK



34 CHESTNUT



39 POLAR BIRCH



64 COCOA

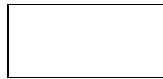

67 WHITE PASTEL



106 LOWLAND NUT



154 ANTHRACITE



FRONT



14 BEECH



26 ALUMINUM SATINATO



31 CANADIAN OAK



34 CHESTNUT



39 POLAR BIRCH



64 COCOA

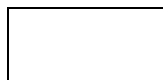

67 WHITE PASTEL



106 LOWLAND NUT



154 ANTHRACITE

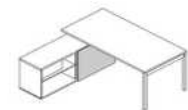

BODY - FIRST GROUP



26 ALUMINUM SATINATO

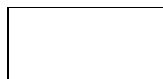

67 WHITE PASTEL



154 ANTHRACITE



BODY - SECOND GROUP



14 BEECH



31 CANADIAN OAK



34 CHESTNUT



39 POLAR BIRCH



64 COCOA



106 LOWLAND NUT



FRAME, - OGI\_N



M015 WHITE SEMI-MATTE

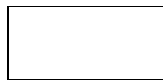

67 WHITE PASTEL



M009 ALUMINUM SEMI-MATTE



26 ALUMINUM SATINATO



M154-ANTHRACITE SEMI-MATTE



154 ANTHRACITE



**TECHNICAL SPECIFICATION**

**COLOURS**

**LEGS PLATE, - OGI\_V**



26 ALUMINUM  
SATINATO

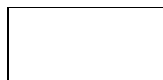

67 WHITE PASTEL



154 ANTHRACITE



**FRAME - OGI\_A, OGI\_Q, OGI\_U, OGI\_Y, OGI DRIVE**



M009 ALUMINUM  
SEMI-MATTE



M015 WHITE  
SEMI-MATTE



M154-  
ANTHRACITE  
SEMI-MATTE



**DESK EXTENSTIONS - WORKTOP - PLU01, PLY01**



14 BEECH



26 ALUMINUM  
SATINATO

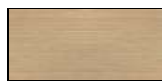

31 CANADIAN OAK

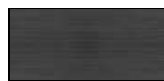

34 CHESTNUT



39 POLAR BIRCH



64 COCOA

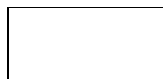

67 WHITE PASTEL

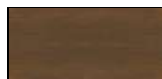

106 LOWLAND NUT



154 ANTHRACITE



**DESK EXTENSTIONS - FRAME - PLU01, PLY01**



M009 ALUMINUM  
SEMI-MATTE

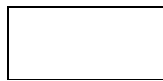

M015 WHITE  
SEMI-MATTE



M154-  
ANTHRACITE  
SEMI-MATTE



**GROMMET - BLACK**



34 CHESTNUT



64 COCOA

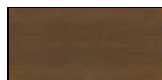

106 LOWLAND NUT



154 ANTHRACITE



**GROMMET - WHITE**

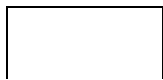

67 WHITE PASTEL



**GROMMET - ALUMINUM**



14 BEECH



26 ALUMINUM  
SATINATO



31 CANADIAN OAK



39 POLAR BIRCH



TECHNICAL SPECIFICATION

OGI DESK WORKTOPS

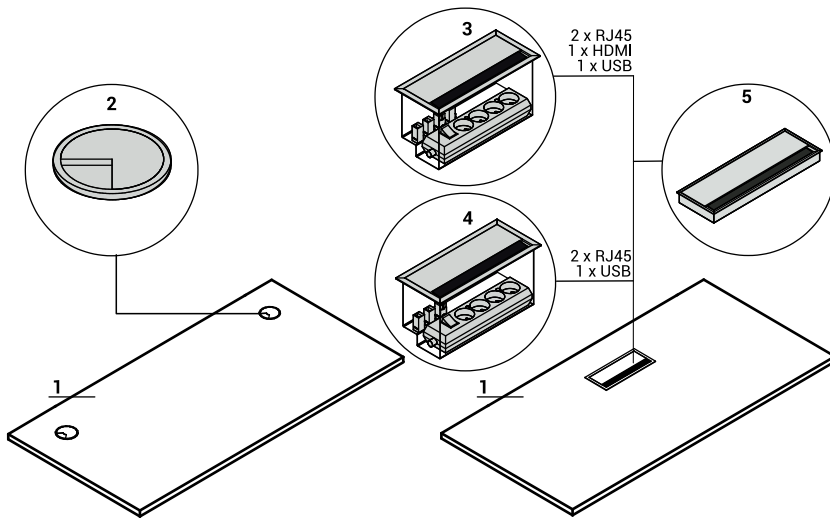

- 1. **Worktop** - MFC 28mm, PVC edge
- 2. **Option with additional charge** - 2x grimmet PVC - ø80mm
- 3. **Option with additional charge** - Mediabox M04H - 2xRJ45 (class E, cat. 6) + 1xUSB + 1xHDMI + 4x230V, colour: M009 - aluminum semi-matte
- 4. **Option with additional charge** - Mediabox M04 - 2xRJ45 (class E, cat. 6) + 1xUSB + 4x230V, colour: M009 - aluminum semi-matte
- 5. **Option with additional charge** - Top access M05 - colour: M009 - aluminum semi-matte

WORKTOP - CONFIGURATIONS

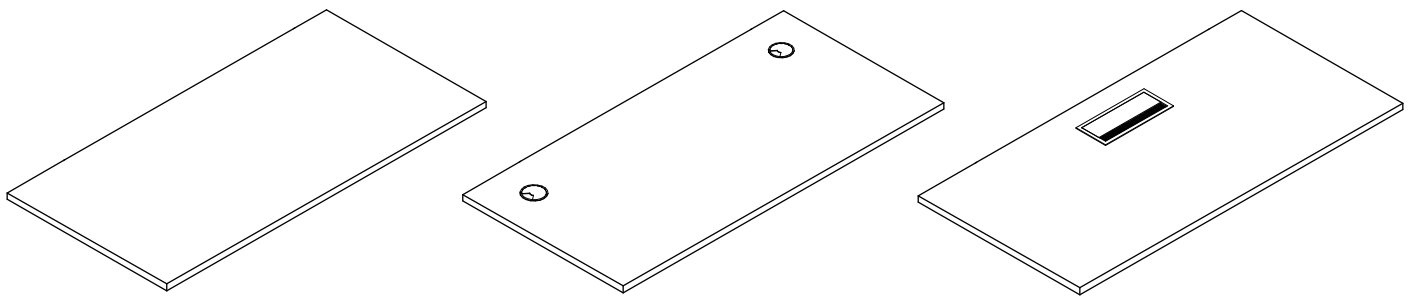

FRAME

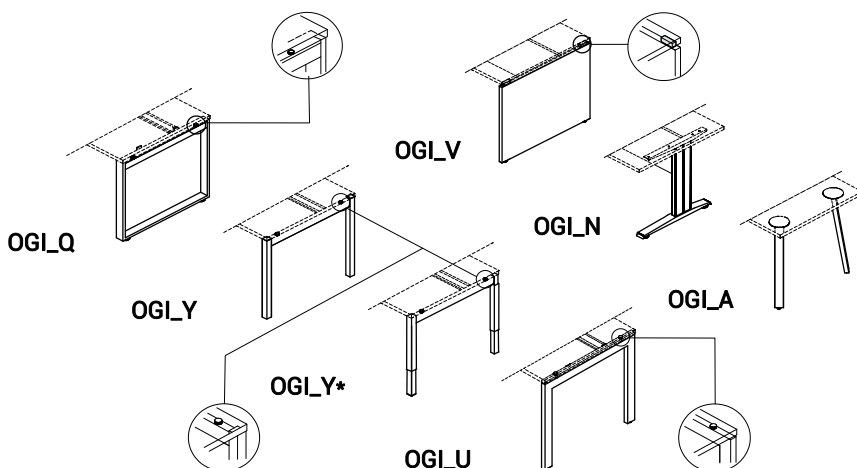

- OGI Q** - powder coated steel, profile 60x20mm,
- OGI Y** - powder coated steel, profile 40x40mm, between top and frame spacer - 10mm
- \*OGI Y with manual height adjustment 640 - 860mm**, every 20mm - powder painted steel, telescopic profile: 30x30 into 40x40mm
- OGI U** - powder coated steel, profile 60x30mm, between top and frame spacer - 10mm
- OGI V** - legs - MFC 28mm, modesty panel - MFC 18mm, aluminum spacer 60x20mm between top and leg
- OGI N** - powder coated metal, column 642x149x36mm, foot 647x60mm, vertical cable management, modesty panel - MFC 18mm
- OGI A** - powder coated steel, profile 60x30mm

TECHNICAL SPECIFICATION

DESK EXTENSIONS

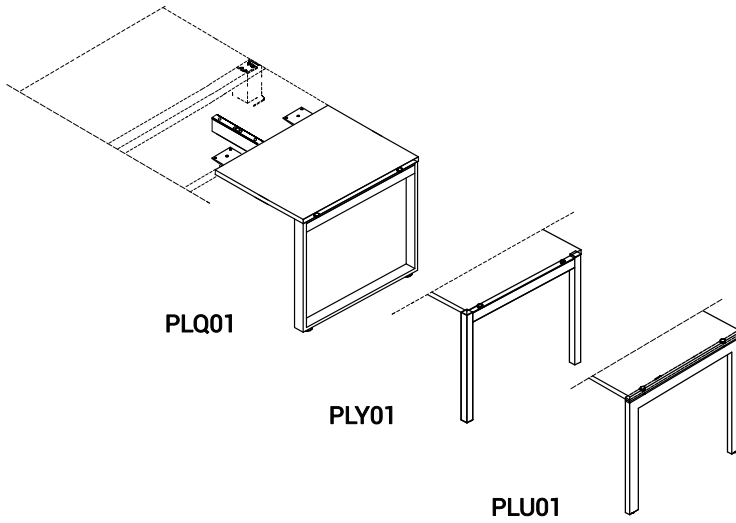

- PLQ01 - OGI Q extension
- PLU01 - OGI U extension
- PLY01- OGI Y extension

DESK WITH MANAGERIAL STORAGE

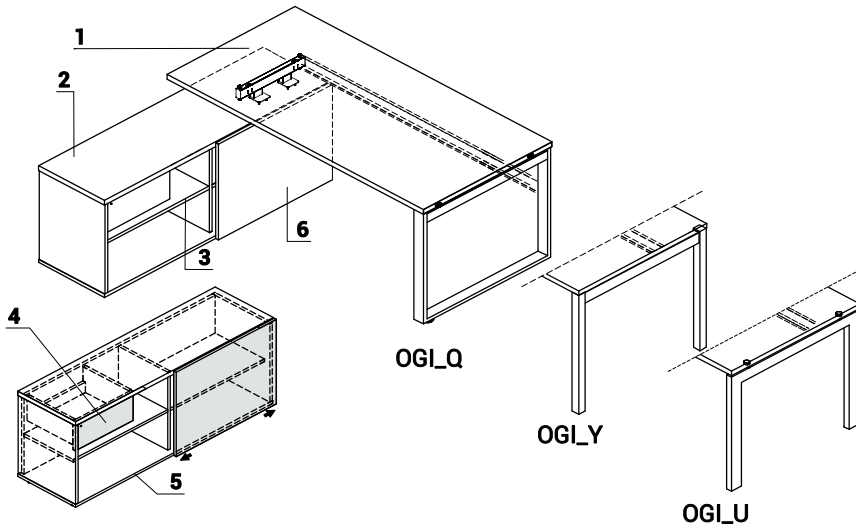

1. **Worktop** - MFC 28mm, PVC edge
2. **Top** - MFC 28mm, PVC edge
3. **Shelf** - MFC 18mm, PVC edge
4. **Drawer** - MFC 18mm, PVC edge, lock - possible to change location
5. **Base** - MFC 18mm, PVC edge
6. **Front** - MFC 18mm, PVC edge

POSSIBLE CONFIGURATIONS

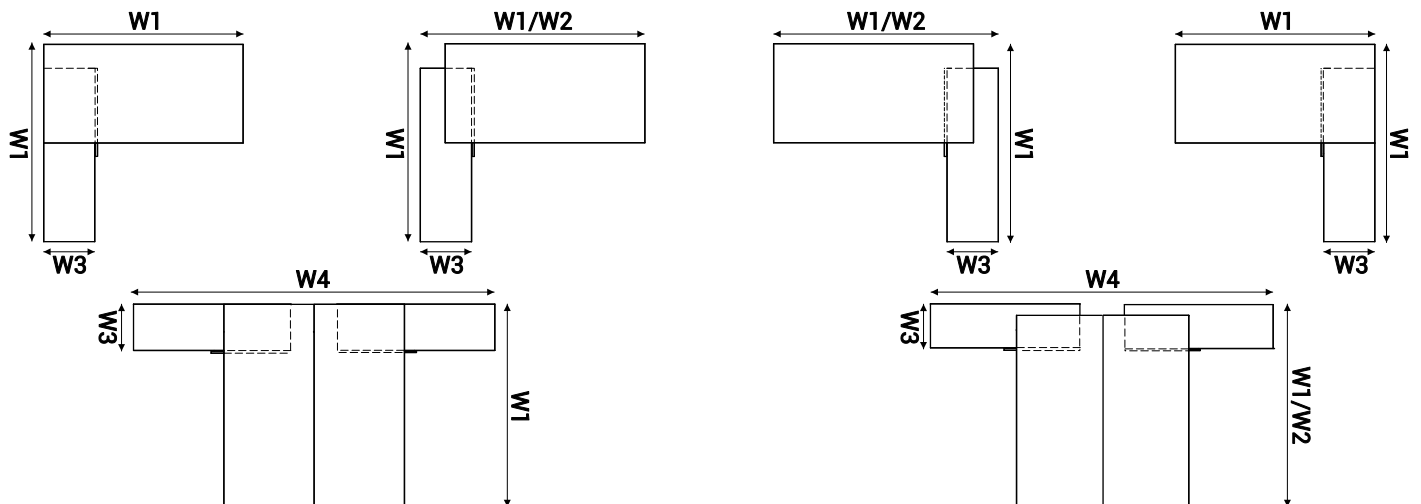

W1 - 1600 | W2 - 1702 | W3 - 432 | W4 - 3218

**TECHNICAL SPECIFICATION**

**ELECTRIC HEIGHT ADJUSTABLE FRAME - DRIVE**

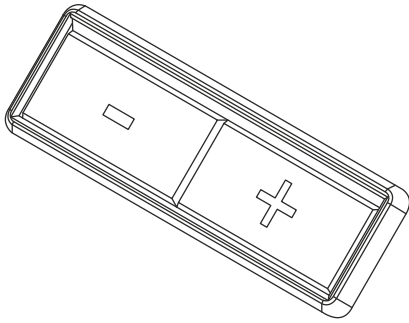

**FRAME TECHNICAL SPECIFICATION**

**Height adjustment** - 40mm/sec Super Soft Start - Stop

**Drive** - 2 synchronised motors with microprocessor, work control sensor

**Noise level** - <48dB

Anti collision mechanism

**Control panel** - electrical height adjustment - memory

**Norms** - ISO 21016, EN 527-2, EN 527 -3

**EU Directives** - 206/95EC, UI508 1999, UL 1004 R7 06, WE DC 2004/108WE

**Power supply** - 230V, 300W, power consumption on Standby - 0.3W

**OGI DRIVE - DIMENSIONS**

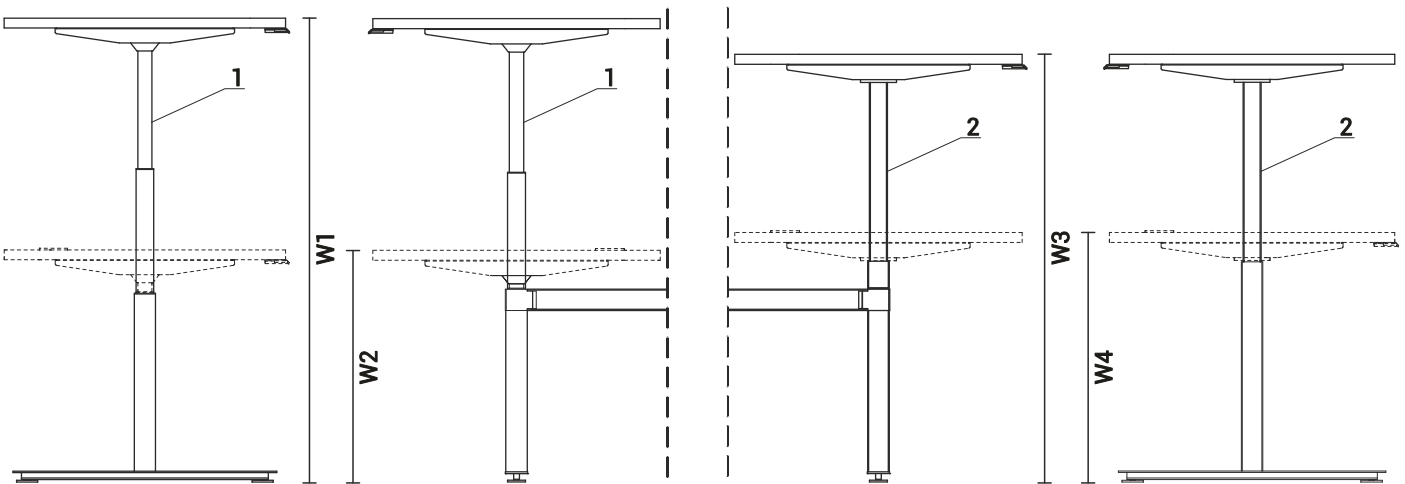

1. STROKE 650 - 3 profiles, W1 - 1300mm | W2 - 650mm | 2. STROKE 500 - 2 profiles, W3 - 1200mm | W4 - 700mm

**ELECTRIC HEIGHT ADJUSTABLE FRAME - OGI DRIVE**

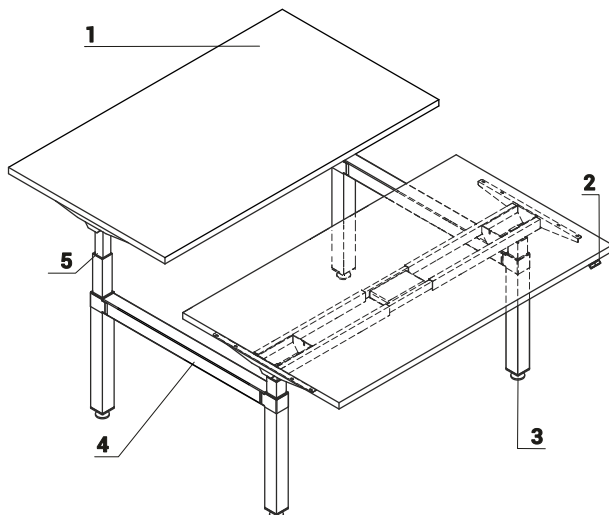

- 1. **Worktop** - MFC 28mm, PVC edge
- 2. Control panel
- 3. **Leveling feet** - range 5mm
- 4. Metal element for legs connecting
- 5. **Electric height adjustable base** - powder coated steel, load 100kg, telescopic leg

ATTENTION - distance between bench worktops 90mm

TECHNICAL SPECIFICATION

ACCESSORIES

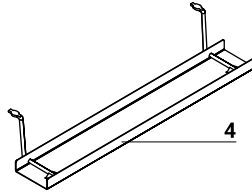
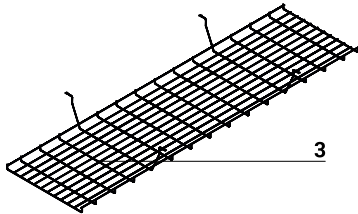
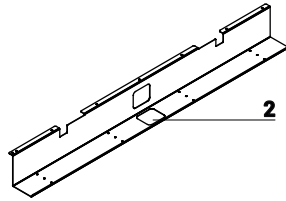
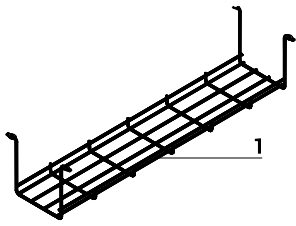

1. **Horizontal cable tray S69** - powder painted, colour: 09 - aluminum
2. **Single desk horizontal cable tray (SG12, SG16)** - powder painted metal, colour: M009 - aluminum semi-matte
3. **Cable tray for desks of the type Bench (SG220, SG260)** - steel wire Ø4mm, powdercoated, colour: 09 - Aluminum
4. **Horizontal cable tray E64** - powder painted, colour: M009 - aluminum semi matte

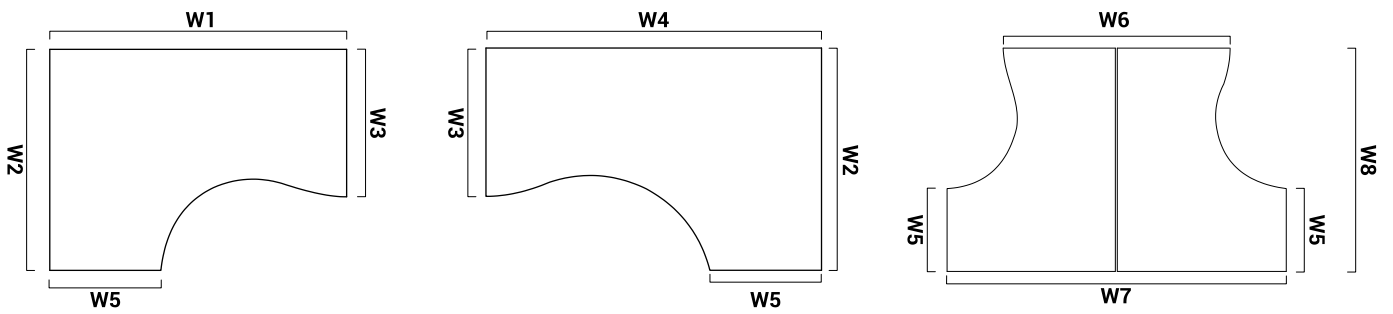

W1 - 1600mm | W2 - 1200mm | W3 - 800mm | W4 - 1800mm | W5 - 600mm | W6 - 1610mm | W7 - 2410mm | W8 - 1600mm

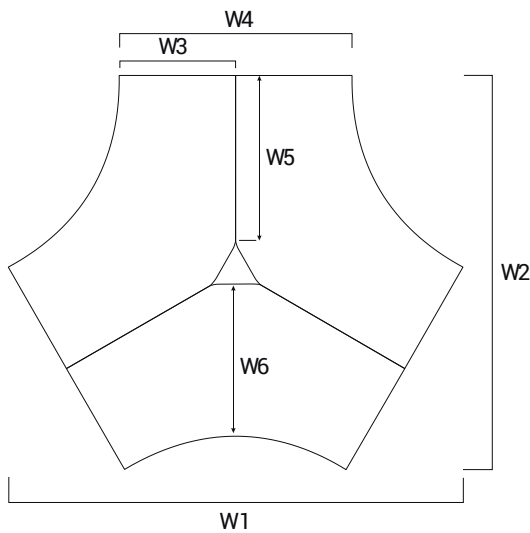



W1 - 2343mm | W2 - 2029mm | W3 - 600mm | W4 - 1200mm | W5 - 844mm | W6 - 786mm

**TECHNICAL SPECIFICATION**

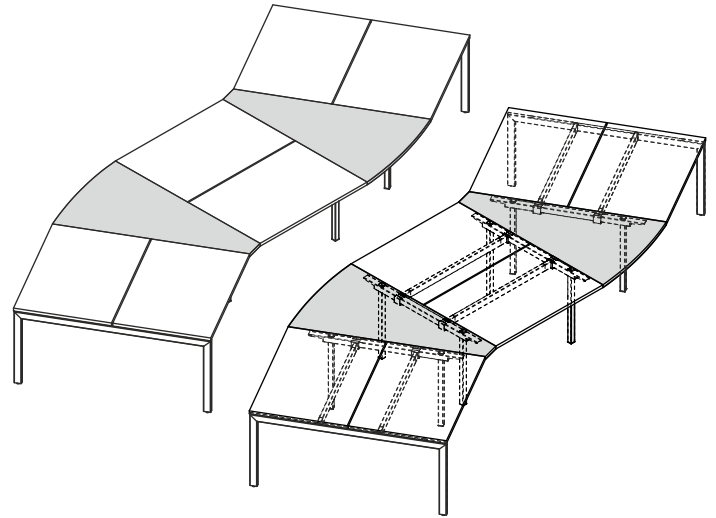
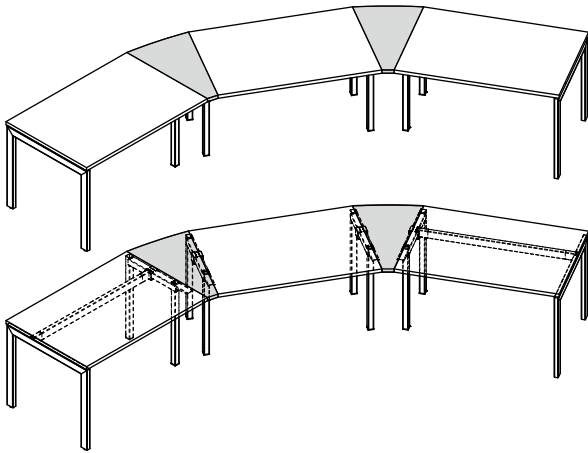



**SAMPLE CONFIGURATIONS WITH BOX40, BOX50, BOX60**





ATTENTION – only for OGI Q, OGI U, OGI Y

PRODUCT ILLUSTRATION	DIMENSIONS [mm]			INDEX SYMBOL					COMMENTS
	WIDTH	DEPTH	HEIGHT			kg	m3	pcs	

**SINGLE DESKS ELECTRIC HEIGHT ADJUSTMENT – STROKE 500 mm**

	1200	800	700 1200	<b>BOD52</b>		43.1	0.069	3	
	1400	800	700 1200	<b>BOD54</b>		45.6	0.075	3	
	1600	800	700 1200	<b>BOD56</b>		48.6	0.080	3	
	1800	800	700 1200	<b>BOD58</b>		51.6	0.086	3	
	2000	800	700 1200	<b>BOD60</b>		54.6	0.092	3	

**ADDITIONAL CHARGE**

FEATURE	PRODUCT													COMMENTS
	BOD52	BOD54	BOD56	BOD58	BOD60						kg	m3	pcs	
CABLE GROMMETS											0.1	0.0001	1	
MEDIABOX M04H											0.1	0.0001	1	
MEDIABOX M04											0.9	0.0070	1	
TOP ACCESS M05											0.9	0.0070	1	
UP-AND-DOWN KEYPAD WITH MEMORY											0.0	0.0000	0	

DESCRIPTION

 - NET WEIGHT

 VOLUME

 NUMBER OF PACKAGES



PRODUCT ILLUSTRATION	DIMENSIONS [mm]			INDEX SYMBOL					COMMENTS
	WIDTH	DEPTH	HEIGHT			kg	m3	pcs	

**BENCH DESKS WITH ELECTRIC HEIGHT ADJUSTMENT – STROKE 500 mm**

	1200	1690	700 1200	<b>BOD512</b>		83.8	0.150	6	
	1400	1690	700 1200	<b>BOD514</b>		88.8	0.162	6	
	1600	1690	700 1200	<b>BOD516</b>		94.8	0.173	6	
	1800	1690	700 1200	<b>BOD518</b>		100.8	0.185	6	
	2000	1690	700 1200	<b>BOD520</b>		0.0	0.001	0	

**ADDITIONAL CHARGE**

FEATURE	PRODUCT													COMMENTS
	BOD512	BOD514	BOD516	BOD518	BOD520						kg	m3	pcs	
CABLE GROMMETS											0.1	0.0001	1	
MEDIABOX M04H											0.1	0.0001	1	
MEDIABOX M04											0.9	0.0070	1	
TOP ACCESS M05											0.9	0.0070	1	
UP-AND-DOWN KEYPAD WITH MEMORY											0.0	0.0000	0	

DESCRIPTION

- NET WEIGHT

VOLUME

NUMBER OF PACKAGES

PRODUCT ILLUSTRATION	DIMENSIONS [mm]			INDEX SYMBOL					COMMENTS
	WIDTH	DEPTH	HEIGHT			kg	m3	pcs	

**SINGLE DESKS ELECTRIC HEIGHT ADJUSTMENT – STROKE 650 mm**

	1200	800	650 1300	<b>BOD62</b>		45.6	0.062	3	
	1400	800	650 1300	<b>BOD64</b>		48.1	0.068	3	
	1600	800	650 1300	<b>BOD66</b>		51.1	0.073	3	
	1800	800	650 1300	<b>BOD68</b>		54.1	0.079	3	
	2000	800	650 1300	<b>BOD70</b>		57.1	0.085	3	

**ADDITIONAL CHARGE**

FEATURE	PRODUCT													COMMENTS
	BOD62	BOD64	BOD66	BOD68	BOD70						kg	m3	pcs	
CABLE GROMMETS											0.1	0.0001	1	
MEDIABOX M04H											0.1	0.0001	1	
MEDIABOX M04											0.9	0.0070	1	
TOP ACCESS M05											0.9	0.0070	1	
UP-AND-DOWN KEYPAD WITH MEMORY											0.0	0.0000	0	

DESCRIPTION

- NET WEIGHT

VOLUME

NUMBER OF PACKAGES

PRODUCT ILLUSTRATION	DIMENSIONS [mm]			INDEX SYMBOL					COMMENTS
	WIDTH	DEPTH	HEIGHT			kg	m3	pcs	

**BENCH DESKS WITH ELECTRIC HEIGHT ADJUSTMENT – STROKE 650 mm**

	1200	1690	650 1300	<b>BOD612</b>		88.8	0.137	6	
	1400	1690	650 1300	<b>BOD614</b>		93.8	0.148	6	
	1600	1690	650 1300	<b>BOD616</b>		99.8	0.159	6	
	1800	1690	650 1300	<b>BOD618</b>		105.8	0.171	6	
	2000	1690	650 1300	<b>BOD620</b>		0.0	0.001	0	

**ADDITIONAL CHARGE**

FEATURE	PRODUCT													COMMENTS
	BOD612	BOD614	BOD616	BOD618	BOD620						kg	m3	pcs	
CABLE GROMMETS											0.1	0.0001	1	
MEDIABOX M04H											0.1	0.0001	1	
MEDIABOX M04											0.9	0.0070	1	
TOP ACCESS M05											0.9	0.0070	1	
UP-AND-DOWN KEYPAD WITH MEMORY											0.0	0.0000	0	

DESCRIPTION

- NET WEIGHT

VOLUME

NUMBER OF PACKAGES

PRODUCT ILLUSTRATION	DIMENSIONS [mm]			INDEX SYMBOL					COMMENTS
	WIDTH	DEPTH	HEIGHT			kg	m3	pcs	

**SONIC - ACOUSTIC PANELS FOR BENCH DESKS**

	1190	40	800	<b>ZD812</b>		14.0	0.051	2	for 1200mm wide benches only
	1390	40	800	<b>ZD814</b>		15.0	0.059	2	for 1400mm wide benches only
	1590	40	800	<b>ZD816</b>		16.0	0.068	2	for 1600mm wide benches only
	1790	40	800	<b>ZD818</b>		17.0	0.076	2	for 1800mm wide benches only
	1990	40	800	<b>ZD820</b>		0.0	0.001	0	for 2000mm wide benches only

**ADDITIONAL CHARGE**



FEATURE	PRODUCT													COMMENTS
	ZD812	ZD814	ZD816	ZD818	ZD820						kg	m3	pcs	
II PRICE GROUP											0.0	0.0000	0	
III PRICE GROUP											1.0	0.0010	1	

DESCRIPTION









- NET WEIGHT

VOLUME



NUMBER OF PACKAGES

PRODUCT ILLUSTRATION	DIMENSIONS [mm]			INDEX SYMBOL						COMMENTS
	WIDTH	DEPTH	HEIGHT			kg	m3	pcs		

**DESKS**

	1200	600	740	<b>BAG026</b>		25.0	0.035	5		
	1400	600	740	<b>BAG036</b>		24.0	0.039	5		
	1600	600	740	<b>BAG046</b>		26.0	0.043	5		
	1200	700	740	<b>BAG027</b>		24.0	0.039	5		
	1400	700	740	<b>BAG037</b>		27.0	0.044	5		
	1600	700	740	<b>BAG047</b>		29.0	0.049	5		
	1200	800	740	<b>BAG028</b>		26.0	0.043	5		
	1400	800	740	<b>BAG038</b>		29.0	0.049	5		
	1600	800	740	<b>BAG048</b>		32.0	0.055	5		

**ADDITIONAL CHARGE**



FEATURE	PRODUCT													COMMENTS
	BAG026	BAG036	BAG046	BAG027	BAG037	BAG047	BAG028	BAG038	BAG048		kg	m3	pcs	
CABLE GROMMETS											0.1	0.0001	1	
MEDIABOX M04H											0.9	0.0070	1	
MEDIABOX M04											0.9	0.0070	1	
TOP ACCESS M05											0.0	0.0000	0	

DESCRIPTION



 - NET WEIGHT

 VOLUME

 NUMBER OF PACKAGES

PRODUCT ILLUSTRATION	DIMENSIONS [mm]			INDEX SYMBOL						COMMENTS
	WIDTH	DEPTH	HEIGHT			kg	m3	pcs		

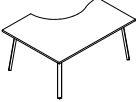

**RADIAL DESKS**

	1600	1200	740	<b>BAG10</b>		37.0	0.078	5		
	1600	1200	740	<b>BAG11</b>		37.0	0.078	5		
	2343	2029	740	<b>BAG12</b>		93.6	0.198	15		suitable panels ZOT78, ZOT79, ZOS78, ZOS79

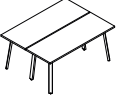
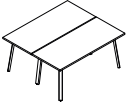
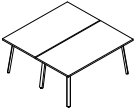

**BENCH DESKS**

	1600	1210	740	<b>BAG0214</b>		48.0	0.082	8		only cable tray SG220 can be mounted
	1600	1410	740	<b>BAG0216</b>		54.0	0.094	8		only cable tray SG220 can be mounted
	1600	1610	740	<b>BAG0218</b>		60.0	0.105	8		only cable tray SG220 can be mounted

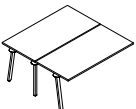
**ELEMENTS FOR DESKS PAIRING**

	1600	1210	740	<b>BAG0414</b>		42.0	0.076	5		straight middle leg made from 40x40 profile
	1600	1410	740	<b>BAG0416</b>		48.0	0.088	5		straight middle leg made from 40x40 profile
	1600	1610	740	<b>BAG0418</b>		54.0	0.099	5		straight middle leg made from 40x40 profile

**ADDITIONAL CHARGE**



FEATURE	PRODUCT												COMMENTS
	BAG10	BAG11		BAG0214	BAG0216	BAG0218	BAG0414	BAG0416	BAG0418	kg	m3	pcs	
CABLE GROMMETS										0.1	0.0001	1	
MEDIABOX M04H										0.9	0.0070	1	
MEDIABOX M04										0.9	0.0070	1	
TOP ACCESS M05										0.0	0.0000	0	

DESCRIPTION







 - NET WEIGHT

 VOLUME

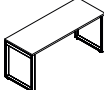
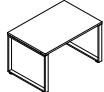
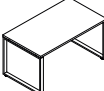

 NUMBER OF PACKAGES

PRODUCT ILLUSTRATION	DIMENSIONS [mm]			INDEX SYMBOL						COMMENTS
	WIDTH	DEPTH	HEIGHT			kg	m3	pcs		

**DESKS**

	1200	600	740	<b>BOQ12</b>		32.0	0.093	4		
	1400	600	740	<b>BOQ14</b>		35.0	0.099	4		
	1600	600	740	<b>BOQ16</b>		38.1	0.104	4		
	1200	800	740	<b>BOQ02</b>		41.0	0.117	3		
	1400	800	740	<b>BOQ03</b>		41.5	0.124	3		
	1600	800	740	<b>BOQ04</b>		42.1	0.131	3		
	1800	800	740	<b>BOQ05</b>		45.2	0.138	3		
	2000	800	740	<b>BOQ06</b>		51.5	0.145	3		

**ADDITIONAL CHARGE**



FEATURE	PRODUCT												COMMENTS
	BOQ12	BOQ14	BOQ16	BOQ02	BOQ03	BOQ04	BOQ05	BOQ06		kg	m3	pcs	
CABLE GROMMETS										0.1	0.0001	1	
MEDIABOX M04H										0.9	0.0070	1	
MEDIABOX M04										0.9	0.0070	1	
TOP ACCESS M05										0.0	0.0000	0	

DESCRIPTION





 - NET WEIGHT

 VOLUME

 NUMBER OF PACKAGES

PRODUCT ILLUSTRATION	DIMENSIONS [mm]			INDEX SYMBOL						COMMENTS
	WIDTH	DEPTH	HEIGHT			kg	m3	pcs		

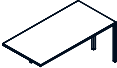

**ELEMENTS FOR DESKS PAIRING**

	500	800	740	<b>BOX40</b>		10.8	0.052	2		Fixing only for edges 800mm
	1200	800	740	<b>BOX42</b>		31.6	0.079	3		Fixing only for edges 800mm, 40x40
	1400	800	740	<b>BOX43</b>		32.1	0.086	3		Fixing only for edges 800mm, 40x40
	1600	800	740	<b>BOX44</b>		32.7	0.093	3		Fixing only for edges 800mm, 40x40
	1800	800	740	<b>BOX45</b>		35.8	0.100	3		Fixing only for edges 800mm, 40x40

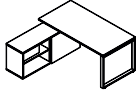
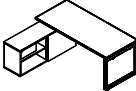
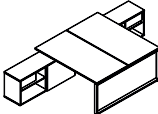
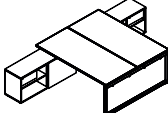
**DESKS WITH MANAGERIAL SIDE STORAGE**

	1600 1702	1600	740	<b>BOQL20</b>		94.4	0.249	8		universal left/right
	1800 1902	1600	740	<b>BOQL21</b>		97.5	0.256	8		universal left/right
	1600 1702	3210	740	<b>BOQL40</b>		185.8	0.498	15		
	1800 1902	3210	740	<b>BOQL41</b>		192.0	0.511	15		

**ADDITIONAL CHARGE**

FEATURE	PRODUCT											COMMENTS
	BOX42	BOX43	BOX44	BOX45	BOQL20	BOQL21	BOQL40	BOQL41	kg	m3	pcs	
CABLE GROMMETS									0.1	0.0001	1	
MEDIABOX M04H									0.9	0.0070	1	
MEDIABOX M04									0.9	0.0070	1	
TOP ACCESS M05									0.0	0.0000	0	
II PRICE GROUP									0.0	0.0000	0	



DESCRIPTION

 - NET WEIGHT

 VOLUME

 NUMBER OF PACKAGES



PRODUCT ILLUSTRATION	DIMENSIONS [mm]			INDEX SYMBOL						COMMENTS
	WIDTH	DEPTH	HEIGHT			kg	m3	pcs		

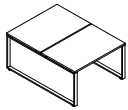
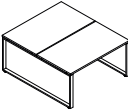
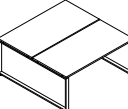
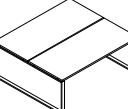

**BENCH DESKS**

	1200	1610	740	<b>BOQ32</b>		61.6	0.235	5		
	1400	1610	740	<b>BOQ33</b>		62.6	0.249	5		
	1600	1610	740	<b>BOQ34</b>		63.8	0.263	5		
	1800	1610	740	<b>BOQ35</b>		70.0	0.276	5		

**ELEMENTS FOR DESKS PAIRING**

	1000	1610	740	<b>BOX60</b>		17.5	0.133	2		
	1200	1610	740	<b>BOX62</b>		60.1	0.159	5		
	1400	1610	740	<b>BOX64</b>		61.1	0.173	5		
	1600	1610	740	<b>BOX66</b>		62.3	0.187	5		
	1800	1610	740	<b>BOX68</b>		68.5	0.200	5		

**ADDITIONAL CHARGE**



FEATURE	PRODUCT											COMMENTS
	BOQ32	BOQ33	BOQ34	BOQ35	BOX62	BOX64	BOX66	BOX68	kg	m3	pcs	
CABLE GROMMETS									0.1	0.0001	1	
MEDIABOX M04H									0.9	0.0070	1	
MEDIABOX M04									0.9	0.0070	1	
TOP ACCESS M05	100,-								0.0	0.0000	0	

DESCRIPTION



 - NET WEIGHT

 VOLUME

 NUMBER OF PACKAGES

PRODUCT ILLUSTRATION	DIMENSIONS [mm]			INDEX SYMBOL						COMMENTS
	WIDTH	DEPTH	HEIGHT			kg	m3	pcs		

**DESK EXTENSION**



	600	800	740	PLQ01		19.5	0.051	5		
	600	1000	740	PLQ02		20.7	0.056	5		
	600	1200	740	PLQ03		23.2	0.061	5		

DESCRIPTION



 - NET WEIGHT

 VOLUME



 NUMBER OF PACKAGES

PRODUCT ILLUSTRATION	DIMENSIONS [mm]			INDEX SYMBOL						COMMENTS
	WIDTH	DEPTH	HEIGHT			kg	m3	pcs		

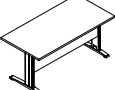
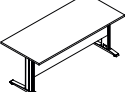

**DESKS**

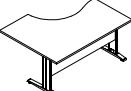
	1200	800	740	<b>BNG02</b>		32.6	0.100	3		
	1400	800	740	<b>BNG03</b>		37.0	0.108	3		
	1600	800	740	<b>BNG04</b>		41.9	0.122	3		
	1800	800	740	<b>BNG05</b>		45.3	0.124	3		

**RADIAL DESKS**

	1600	1200	740	<b>BNG10</b>		45.9	0.145	3		use adequate supporting leg
	1600	1200	740	<b>BNG11</b>		45.9	0.145	3		use adequate supporting leg
	1800	1200	740	<b>BNG17</b>		52.9	0.149	3		use adequate supporting leg
	1800	1200	740	<b>BNG18</b>		52.9	0.149	3		use adequate supporting leg

**ADDITIONAL CHARGE**



FEATURE	PRODUCT											COMMENTS
	BNG02	BNG03	BNG04	BNG05	BNG10	BNG11	BNG17	BNG18	kg	m3	pcs	
CABLE GROMMETS									0.1	0.0001	1	
MEDIABOX M04H									0.9	0.0070	1	
MEDIABOX M04									0.9	0.0070	1	
TOP ACCESS M05									0.0	0.0000	0	

DESCRIPTION







 - NET WEIGHT

 VOLUME

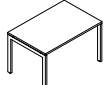

 NUMBER OF PACKAGES

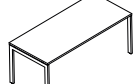
PRODUCT ILLUSTRATION	DIMENSIONS [mm]			INDEX SYMBOL						COMMENTS
	WIDTH	DEPTH	HEIGHT			kg	m3	pcs		

**DESKS**

	1200	600	740	<b>BOU12</b>		29.8	0.067	4		
	1400	600	740	<b>BOU14</b>		32.8	0.072	4		
	1600	600	740	<b>BOU16</b>		35.9	0.078	4		
	1200	800	740	<b>BOU19</b>		37.8	0.069	3		
	1400	800	740	<b>BOU20</b>		38.3	0.076	3		
	1600	800	740	<b>BOU21</b>		38.9	0.083	3		
	1800	800	740	<b>BOU22</b>		42.0	0.090	3		
	2000	800	740	<b>BOU27</b>		48.3	0.097	3		

**ADDITIONAL CHARGE**



FEATURE	PRODUCT												COMMENTS	
	BOU12	BOU14	BOU16	BOU19	BOU20	BOU21	BOU22	BOU27			kg	m3		pcs
CABLE GROMMETS											0.1	0.0001	1	
MEDIABOX M04H											0.9	0.0070	1	
MEDIABOX M04											0.9	0.0070	1	
TOP ACCESS M05											0.0	0.0000	0	

DESCRIPTION





 - NET WEIGHT

 VOLUME

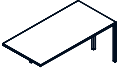

 NUMBER OF PACKAGES

PRODUCT ILLUSTRATION	DIMENSIONS [mm]			INDEX SYMBOL					COMMENTS
	WIDTH	DEPTH	HEIGHT			kg	m3	pcs	

**ELEMENTS FOR DESKS PAIRING**

	500	800	740	<b>BOX40</b>		10.8	0.052	2	Fixing only for edges 800mm
	1200	800	740	<b>BOX42</b>		31.6	0.079	3	Fixing only for edges 800mm, 40x40
	1400	800	740	<b>BOX43</b>		32.1	0.086	3	Fixing only for edges 800mm, 40x40
	1600	800	740	<b>BOX44</b>		32.7	0.093	3	Fixing only for edges 800mm, 40x40
	1800	800	740	<b>BOX45</b>		35.8	0.100	3	Fixing only for edges 800mm, 40x40

**ADDITIONAL CHARGE**

FEATURE	PRODUCT											COMMENTS
	BOX42	BOX43	BOX44	BOX45					kg	m3	pcs	
CABLE GROMMETS									0.1	0.0001	1	
MEDIABOX M04H									0.9	0.0070	1	
MEDIABOX M04									0.9	0.0070	1	
TOP ACCESS M05									0.0	0.0000	0	

DESCRIPTION

 - NET WEIGHT

 VOLUME

 NUMBER OF PACKAGES

PRODUCT ILLUSTRATION	DIMENSIONS [mm]			INDEX SYMBOL						COMMENTS
	WIDTH	DEPTH	HEIGHT			kg	m3	pcs		

**RADIAL DESKS**

	1600	1200	740	<b>BOU23</b>		44.1	0.109	3		
	1600	1200	740	<b>BOU24</b>		46.1	0.109	3		
	1800	1200	740	<b>BOU25</b>		42.0	0.119	3		
	1800	1200	740	<b>BOU26</b>		44.0	0.119	3		
	1600	2410	740	<b>BOU15</b>		83.5	0.216	5		

**ADDITIONAL CHARGE**



FEATURE	PRODUCT													COMMENTS
	BOU23	BOU24	BOU25	BOU26	BOU15						kg	m3	pcs	
CABLE GROMMETS											0.1	0.0001	1	
MEDIABOX M04H											0.9	0.0070	1	
MEDIABOX M04											0.9	0.0070	1	
TOP ACCESS M05											0.0	0.0000	0	

DESCRIPTION



- NET WEIGHT

VOLUME

NUMBER OF PACKAGES

PRODUCT ILLUSTRATION	DIMENSIONS [mm]			INDEX SYMBOL						COMMENTS
	WIDTH	DEPTH	HEIGHT			kg	m3	pcs		

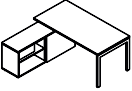

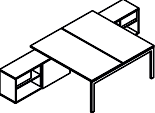
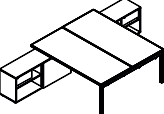
**DESKS WITH MANAGERIAL SIDE STORAGE**

	1600 1702	1600	740	<b>BOUL20</b>		92.9	0.231	8		universal left/right
	1800 1902	1600	740	<b>BOUL21</b>		96.0	0.238	8		universal left/right
	1600 1702	3210	740	<b>BOUL40</b>		182.6	0.463	15		
	1800 1902	3210	740	<b>BOUL41</b>		188.8	0.476	15		

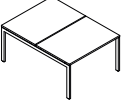
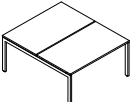
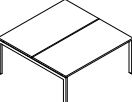
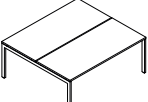
**BENCH DESKS**

	1200	1610	740	<b>BOU32</b>		68.9	0.137	5		
	1400	1610	740	<b>BOU33</b>		69.9	0.151	5		
	1600	1610	740	<b>BOU34</b>		71.1	0.165	5		
	1800	1610	740	<b>BOU35</b>		77.3	0.178	5		

**ADDITIONAL CHARGE**



FEATURE	PRODUCT											COMMENTS
	BOUL20	BOUL21	BOUL40	BOUL41	BOU32	BOU33	BOU34	BOU35	kg	m3	pcs	
CABLE GROMMETS									0.1	0.0001	1	
MEDIABOX M04H									0.9	0.0070	1	
MEDIABOX M04									0.9	0.0070	1	
TOP ACCESS M05									0.0	0.0000	0	
II PRICE GROUP									0.0	0.0000	0	

DESCRIPTION





 - NET WEIGHT

 VOLUME

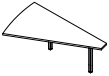

 NUMBER OF PACKAGES

PRODUCT ILLUSTRATION	DIMENSIONS [mm]			INDEX SYMBOL						COMMENTS
	WIDTH	DEPTH	HEIGHT			kg	m3	pcs		

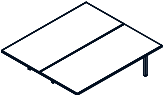

**ELEMENTS FOR DESKS PAIRING**

	1000	1610	740	<b>BOX60</b>		17.5	0.133	2		
	1200	1610	740	<b>BOX62</b>		60.1	0.159	5		
	1400	1610	740	<b>BOX64</b>		61.1	0.173	5		
	1600	1610	740	<b>BOX66</b>		62.3	0.187	5		
	1800	1610	740	<b>BOX68</b>		68.5	0.200	5		

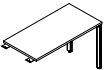
**DESK EXTENSION**

	600	800	740	<b>PLU01</b>		18.4	0.038	5		
	600	1000	740	<b>PLU02</b>		19.6	0.043	5		
	600	1200	740	<b>PLU03</b>		22.1	0.048	5		

**ADDITIONAL CHARGE**

FEATURE	PRODUCT											COMMENTS
	BOX62	BOX64	BOX66	BOX68					kg	m3	pcs	
CABLE GROMMETS									0.1	0.0001	1	
MEDIABOX M04H									0.9	0.0070	1	
MEDIABOX M04									0.9	0.0070	1	
TOP ACCESS M05									0.0	0.0000	0	



DESCRIPTION

 - NET WEIGHT









 VOLUME

 NUMBER OF PACKAGES





PRODUCT ILLUSTRATION	DIMENSIONS [mm]			INDEX SYMBOL						COMMENTS
	WIDTH	DEPTH	HEIGHT			kg	m3	pcs		

**DESKS**

	1200	600	740	<b>BOY12</b>		30.4	0.076	4		
	1400	600	740	<b>BOY14</b>		33.4	0.081	4		
	1600	600	740	<b>BOY16</b>		36.5	0.087	4		
	1200	700	740	<b>BOY22</b>		31.7	0.066	3		
	1400	700	740	<b>BOY24</b>		35.1	0.073	3		
	1600	700	740	<b>BOY26</b>		38.7	0.079	3		
	1200	800	740	<b>BOY02</b>		37.3	0.075	3		
	1400	800	740	<b>BOY03</b>		37.8	0.082	3		
	1600	800	740	<b>BOY04</b>		38.4	0.089	3		

**ADDITIONAL CHARGE**



FEATURE	PRODUCT													COMMENTS
	BOY12	BOY14	BOY16	BOY22	BOY24	BOY26	BOY02	BOY03	BOY04		kg	m3	pcs	
CABLE GROMMETS											0.1	0.0001	1	
MEDIABOX M04H											0.9	0.0070	1	
MEDIABOX M04											0.9	0.0070	1	
TOP ACCESS M05											0.0	0.0000	0	

DESCRIPTION

 - NET WEIGHT

 VOLUME



 NUMBER OF PACKAGES

PRODUCT ILLUSTRATION	DIMENSIONS [mm]			INDEX SYMBOL						COMMENTS
	WIDTH	DEPTH	HEIGHT			kg	m3	pcs		

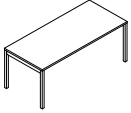
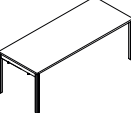
**DESKS**

	1800	800	740	<b>BOY05</b>		41.5	0.096	3		
	2000	800	740	<b>BOY06</b>		47.8	0.103	3		

**ADDITIONAL CHARGE**



FEATURE	PRODUCT													COMMENTS
	BOY05	BOY06									kg	m3	pcs	
CABLE GROMMETS											0.1	0.0001	1	
MEDIABOX M04H											0.9	0.0070	1	
MEDIABOX M04											0.9	0.0070	1	
TOP ACCESS M05											0.0	0.0000	0	

DESCRIPTION







 - NET WEIGHT

 VOLUME



 NUMBER OF PACKAGES

PRODUCT ILLUSTRATION	DIMENSIONS [mm]			INDEX SYMBOL						COMMENTS
	WIDTH	DEPTH	HEIGHT			kg	m3	pcs		

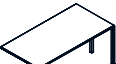
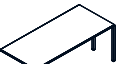
**ELEMENTS FOR DESKS PAIRING**

	1200	700	740	<b>BOX32</b>		26.3	0.068	3		Fixing only for edges 700mm
	1400	700	740	<b>BOX34</b>		29.7	0.075	3		Fixing only for edges 700mm
	1600	700	740	<b>BOX36</b>		33.3	0.081	3		Fixing only for edges 700mm
	500	800	740	<b>BOX40</b>		10.8	0.052	2		Fixing only for edges 800mm
	1200	800	740	<b>BOX42</b>		31.6	0.079	3		Fixing only for edges 800mm, 40x40
	1400	800	740	<b>BOX43</b>		32.1	0.086	3		Fixing only for edges 800mm, 40x40
	1600	800	740	<b>BOX44</b>		32.7	0.093	3		Fixing only for edges 800mm, 40x40
	1800	800	740	<b>BOX45</b>		35.8	0.100	3		Fixing only for edges 800mm, 40x40

**ADDITIONAL CHARGE**



FEATURE	PRODUCT													COMMENTS
	BOY05	BOY06	BOX32	BOX34	BOX36	BOX42	BOX43	BOX44	BOX45		kg	m3	pcs	
CABLE GROMMETS											0.1	0.0001	1	
MEDIABOX M04H											0.9	0.0070	1	
MEDIABOX M04											0.9	0.0070	1	
TOP ACCESS M05											0.0	0.0000	0	

DESCRIPTION





 - NET WEIGHT

 VOLUME

 NUMBER OF PACKAGES

PRODUCT ILLUSTRATION	DIMENSIONS [mm]			INDEX SYMBOL						COMMENTS
	WIDTH	DEPTH	HEIGHT			kg	m3	pcs		

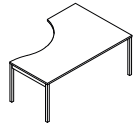

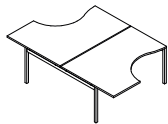
**RADIAL DESKS**

	1600	1200	740	<b>BOY10</b>		43.6	0.115	3		
	1600	1200	740	<b>BOY11</b>		45.6	0.115	3		
	1800	1200	740	<b>BOY17</b>		41.5	0.124	3		
	1800	1200	740	<b>BOY18</b>		43.5	0.124	3		
	1600	2410	740	<b>BOY15</b>		82.9	0.228	5		

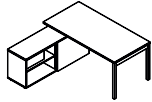
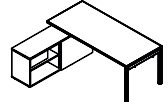
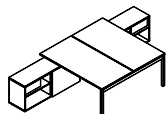
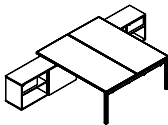
**DESKS WITH MANAGERIAL SIDE STORAGE**

	1600 1702	1600	740	<b>BOYL20</b>		92.5	0.237	8		universal left/right
	1800 1902	1600	740	<b>BOYL21</b>		95.6	0.244	8		universal left/right
	1600 1702	3210	740	<b>BOYL40</b>		181.9	0.475	15		
	1800 1902	3210	740	<b>BOYL41</b>		188.1	0.488	15		

**ADDITIONAL CHARGE**



FEATURE	PRODUCT													COMMENTS
	BOY10	BOY11	BOY17	BOY18	BOY15	BOYL20	BOYL21	BOYL40	BOYL41		kg	m3	pcs	
CABLE GROMMETS											0.1	0.0001	1	
MEDIABOX M04H											0.9	0.0070	1	
MEDIABOX M04											0.9	0.0070	1	
TOP ACCESS M05											0.0	0.0000	0	
II PRICE GROUP											0.0	0.0000	0	

DESCRIPTION



 - NET WEIGHT

 VOLUME



 NUMBER OF PACKAGES

PRODUCT ILLUSTRATION	DIMENSIONS [mm]			INDEX SYMBOL						COMMENTS
	WIDTH	DEPTH	HEIGHT			kg	m3	pcs		

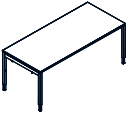
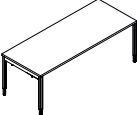
**DESKS WITH MANUAL HEIGHT ADJUSTMENT**

	1200	800	640 860	<b>BOY02R</b>		39.6	0.075	3		height regulation 640 - 860mm, every 20mm
	1400	800	640 860	<b>BOY03R</b>		40.1	0.082	3		height regulation 640 - 860mm, every 20mm
	1600	800	640 860	<b>BOY04R</b>		40.7	0.089	3		height regulation 640 - 860mm, every 20mm
	1800	800	640 860	<b>BOY05R</b>		43.8	0.096	3		height regulation 640 - 860mm, every 20mm
	2000	800	640 860	<b>BOY06R</b>		50.1	0.103	3		height regulation 640 - 860mm, every 20mm

**ADDITIONAL CHARGE**



FEATURE	PRODUCT													COMMENTS
	BOY02R	BOY03R	BOY04R	BOY05R	BOY06R						kg	m3	pcs	
CABLE GROMMETS											0.1	0.0001	1	
MEDIABOX M04H											0.9	0.0070	1	
MEDIABOX M04											0.9	0.0070	1	
TOP ACCESS M05											0.0	0.0000	0	

DESCRIPTION

 - NET WEIGHT

 VOLUME



 NUMBER OF PACKAGES

PRODUCT ILLUSTRATION	DIMENSIONS [mm]			INDEX SYMBOL						COMMENTS
	WIDTH	DEPTH	HEIGHT			kg	m3	pcs		

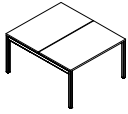
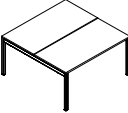
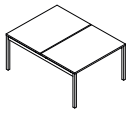
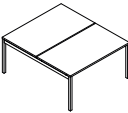
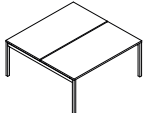
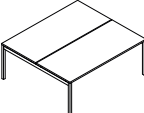
**BENCH DESKS**

	1200	1410	740	<b>BOY42</b>		57.2	0.131	5		
	1400	1410	740	<b>BOY44</b>		64.0	0.143	5		
	1600	1410	740	<b>BOY46</b>		71.2	0.156	5		
	1200	1610	740	<b>BOY32</b>		68.3	0.149	5		
	1400	1610	740	<b>BOY33</b>		69.3	0.163	5		
	1600	1610	740	<b>BOY34</b>		70.5	0.176	5		
	1800	1610	740	<b>BOY35</b>		76.7	0.190	5		

**ADDITIONAL CHARGE**



FEATURE	PRODUCT											COMMENTS
	BOY42	BOY44	BOY46	BOY32	BOY33	BOY34	BOY35		kg	m3	pcs	
CABLE GROMMETS									0.1	0.0001	1	
MEDIABOX M04H									0.9	0.0070	1	
MEDIABOX M04									0.9	0.0070	1	
TOP ACCESS M05									0.0	0.0000	0	

DESCRIPTION







 - NET WEIGHT

 VOLUME

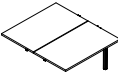
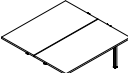
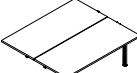

 NUMBER OF PACKAGES

PRODUCT ILLUSTRATION	DIMENSIONS [mm]			INDEX SYMBOL						COMMENTS
	WIDTH	DEPTH	HEIGHT			kg	m3	pcs		

**ELEMENTS FOR DESKS PAIRING**

	1000	1410	740	<b>BOX50</b>		16.5	0.121	2		
	1200	1410	740	<b>BOX52</b>		49.4	0.137	5		
	1400	1410	740	<b>BOX54</b>		56.2	0.150	5		
	1600	1410	740	<b>BOX56</b>		63.4	0.162	5		
	1000	1610	740	<b>BOX60</b>		17.5	0.133	2		
	1200	1610	740	<b>BOX62</b>		60.1	0.159	5		
	1400	1610	740	<b>BOX64</b>		61.1	0.173	5		
	1600	1610	740	<b>BOX66</b>		62.3	0.187	5		
	1800	1610	740	<b>BOX68</b>		68.5	0.200	5		

**ADDITIONAL CHARGE**



FEATURE	PRODUCT											COMMENTS
	BOX52	BOX54	BOX56	BOX62	BOX64	BOX66	BOX68		kg	m3	pcs	
CABLE GROMMETS									0.1	0.0001	1	
MEDIABOX M04H									0.9	0.0070	1	
MEDIABOX M04									0.9	0.0070	1	
TOP ACCESS M05									0.0	0.0000	0	

DESCRIPTION



 - NET WEIGHT

 VOLUME

 NUMBER OF PACKAGES

PRODUCT ILLUSTRATION	DIMENSIONS [mm]			INDEX SYMBOL						COMMENTS
	WIDTH	DEPTH	HEIGHT			kg	m3	pcs		

**DESK EXTENSION**

	600	800	740	<b>PLY01</b>		18.7	0.042	5		
	600	1000	740	<b>PLY02</b>		19.9	0.047	5		
	600	1200	740	<b>PLY03</b>		22.4	0.052	5		



DESCRIPTION

 - NET WEIGHT

 VOLUME

 NUMBER OF PACKAGES



PRODUCT ILLUSTRATION	DIMENSIONS [mm]			INDEX SYMBOL						COMMENTS
	WIDTH	DEPTH	HEIGHT			kg	m3	pcs		

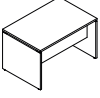
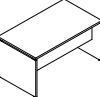
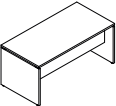
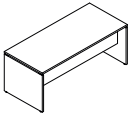

**DESKS**

	1200	800	740	<b>BVG02</b>		45.3	0.096	3		distance from the beam under the worktop - 547 mm - not enough space for pedestal
	1400	800	740	<b>BVG03</b>		49.6	0.104	3		distance from the beam under the worktop - 547 mm - not enough space for pedestal
	1600	800	740	<b>BVG04</b>		53.5	0.113	3		distance from the beam under the worktop - 547 mm - not enough space for pedestal
	1800	800	740	<b>BVG05</b>		57.9	0.120	3		distance from the beam under the worktop - 547 mm - not enough space for pedestal

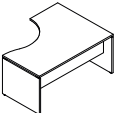
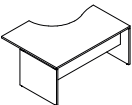
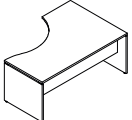
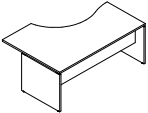
**RADIAL DESKS**

	1600	1200	740	<b>BVG10</b>		57.5	0.135	3		distance from the beam under the worktop - 547 mm - (by narrower edge) - not enough space for pedestal
	1600	1200	740	<b>BVG11</b>		57.5	0.135	3		distance from the beam under the worktop - 547 mm - (by narrower edge) - not enough space for pedestal
	1800	1200	740	<b>BVG17</b>		65.5	0.145	3		distance from the beam under the worktop - 547 mm - (by narrower edge) - not enough space for pedestal
	1800	1200	740	<b>BVG18</b>		65.5	0.145	3		distance from the beam under the worktop - 547 mm - (by narrower edge) - not enough space for pedestal

**ADDITIONAL CHARGE**



FEATURE	PRODUCT											COMMENTS
	BVG02	BVG03	BVG04	BVG05	BVG10	BVG11	BVG17	BVG18	kg	m3	pcs	
CABLE GROMMETS									0.1	0.0001	1	
MEDIABOX M04H									0.9	0.0070	1	
MEDIABOX M04									0.9	0.0070	1	
TOP ACCESS M05									0.0	0.0000	0	

DESCRIPTION







 - NET WEIGHT

 VOLUME

 NUMBER OF PACKAGES

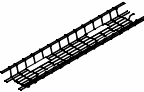
PRODUCT ILLUSTRATION	DIMENSIONS [mm]			INDEX SYMBOL						COMMENTS
	WIDTH	DEPTH	HEIGHT			kg	m3	pcs		

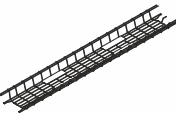
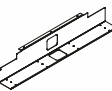
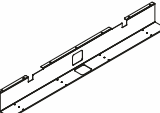
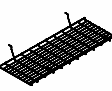
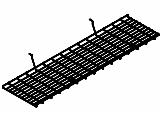
**ACCESSORIES**



	1200	290	77	<b>SOD12</b>		2.0	0.024	1		for benches OGI DRIVE 1200 mm wide
	1400	290	77	<b>SOD14</b>		2.5	0.028	1		for benches OGI DRIVE 1400 mm wide
	1600	290	77	<b>SOD16</b>		3.0	0.032	1		for benches OGI DRIVE 1600 mm wide
	1800	290	77	<b>SOD18</b>		3.5	0.037	1		for benches OGI DRIVE 1800 mm wide
	2000	290	77	<b>SOD20</b>		4.0	0.041	1		for benches OGI DRIVE 2000 mm wide
	760	107	120	<b>SG12</b>		2.0	0.018	1		for single desks width 1200mm and 1400 mm
	1160	107	120	<b>SG16</b>		3.0	0.025	1		for single desks width 1600mm and 1800 mm
	1050	396	130	<b>SG220</b>		2.0	0.081	1		for bench desks 1200mm and 1400mm wide and for OGI A bench desks, excluding OGI DRIVE
	1450	396	130	<b>SG260</b>		2.0	0.111	1		for bench desks 1600mm and 1800mm wide apart from OGI A bench desks, excluding OGI DRIVE
	80	80	23	<b>PK80</b>		0.1	0.000	1		cable grommet 02-gray, 08 - black, 67-white
	275	120	140	<b>M04</b>		0.0	0.001	0		4x230V, 2xRJ45, 1xUSB

DESCRIPTION









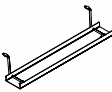

 - NET WEIGHT

 VOLUME

 NUMBER OF PACKAGES

PRODUCT ILLUSTRATION	DIMENSIONS [mm]			INDEX SYMBOL						COMMENTS
	WIDTH	DEPTH	HEIGHT			kg	m3	pcs		

**ACCESSORIES**

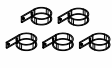

	275	120	140	<b>M04H</b>		0.0	0.001	0		4x230V, 2xRJ45, 1xUSB, 1xHDMI
	275	120	25	<b>M05</b>		0.3	0.002	1		TOP ACCESS
	460	89	120	<b>E64</b>		0.5	0.001	1		horizontal cable tray M009 - aluminum semi - matte
	580	162	123	<b>S69</b>		1.0	0.015	1		09 - aluminum
	140	140	750	<b>S94</b>		1.0	0.004	1		vertical cable duct - colour 09 - aluminum
	470	42	34	<b>S95</b>		1.0	0.001	1		vertical cable organizer, fits to OGI Y desks and OGI A middle leg with profile 40 mm
	470	62	34	<b>S93</b>		1.0	0.002	1		vertical cable organizer, fits to desks DRIVE, YAN, OGIA OGIQ and OGI U (width profile 60mm)
	140	70	750	<b>S81</b>		1.1	0.008	1		vertical cable duct in colour 09 - aluminum, suitable for OGI desk excluding OGI DRIVE
	1000	70	35	<b>S82</b>		1.0	0.005	1		cable rack bracket to install cables under desktop, 09 - aluminum
				<b>AK3</b>		0.2	0.000	1		velcro for cable fixing, 02-grey 6 pcs (3 with screws)
				<b>AK5</b>		0.2	0.000	1		vertical cable holders 5pcs.

DESCRIPTION





 - NET WEIGHT

 VOLUME

 NUMBER OF PACKAGES

PRODUCT ILLUSTRATION	DIMENSIONS [mm]			INDEX SYMBOL						COMMENTS
	WIDTH	DEPTH	HEIGHT			kg	m3	pcs		

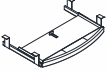
**ACCESSORIES**

	212	460	617	<b>S83</b>		2.6	0.027	1		CPU holder, color: M009 - aluminium semi - matte, M015 - metal white semi - matte, M154 - anthracite semi - matte
	220	470	148	<b>S73</b>		3.2	0.002	1		computer stand (wheels) 26- aluminum
	610	400	85	<b>C01</b>		0.5	0.010	1		keyboard shelf for desks 800mm deep, 02 grey, except from DRIVE desks
	45	50	57	<b>S11</b>		0.2	0.000	1		handbag hanger, colour: M015 - white semi-matte

DESCRIPTION

 - NET WEIGHT

 VOLUME

 NUMBER OF PACKAGES