

Viga M

descriptif technique



.mdd

.mdd, créée en 1993 à Sępólno Krajeńskie en Pologne, est d'abord une histoire d'amitié entre Jaroslaw DABROWSKI et Zbigniew MATTYA.

Depuis l'origine, nous souhaitons incarner un modèle d'entreprise où l'humain est la première des préoccupations. Nous considérons que l'épanouissement personnel de chaque membre de notre équipe, est la clé de notre succès. Garder comme piliers des valeurs familiales participe à ce projet.

Nous créons du mobilier répondant aux besoins spécifiques des espaces de travail. Pour vous permettre de favoriser le travail collaboratif, la créativité et les échanges dans l'entreprise, nous vous proposons un mobilier design, conçu PAR et POUR l'homme. Grâce à notre politique de réinvestissement constant dans l'outil de production nous disposons d'un parc de machines modernes, permettant une fabrication de qualité. Citoyens du monde, nous agissons aujourd'hui en pensant aux générations de demain. Ainsi nous utilisons des matériaux au taux de recyclabilité proche de 95%.

Le monde du travail est en mutation constante. Nous veillons, et collaborons avec des designers et nos clients, pour anticiper et être toujours au plus près du besoin.



Informations générales :

Garantie :

Produits .mdd - **5 ans.**

Composants électriques et tissus - **2 ans.**

Mélaminé - certifié :



Montage :

livrée en pièces détachées

Emballage:

carton, film mousse,
carton structure nid d'abeille

Conforme aux normes :

PN-EN 527-2:2017-02

PN-EN 14073-2:2006

Composition des matériaux *:

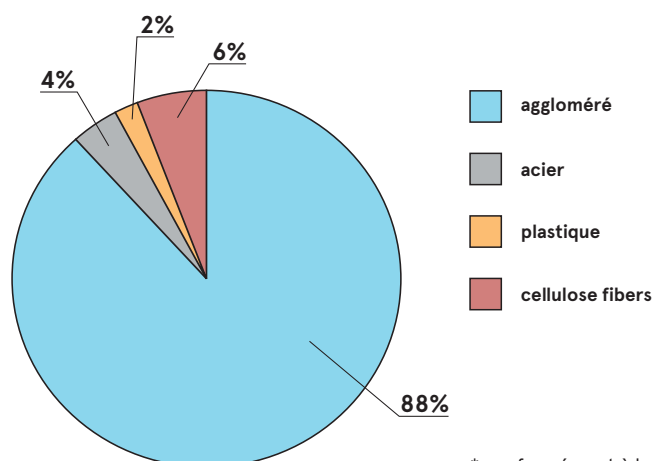

* conformément à la déclaration EPD

Recyclabilité **

Recyclable : 10% - Sous-cyclable : 90%

Contenu recyclé

4%

Empreinte carbone Co2

112,5 kg

** valeurs moyennes pour un représentant du groupe ;
les valeurs peuvent varier d'une référence à l'autre

Bureaux - plateau

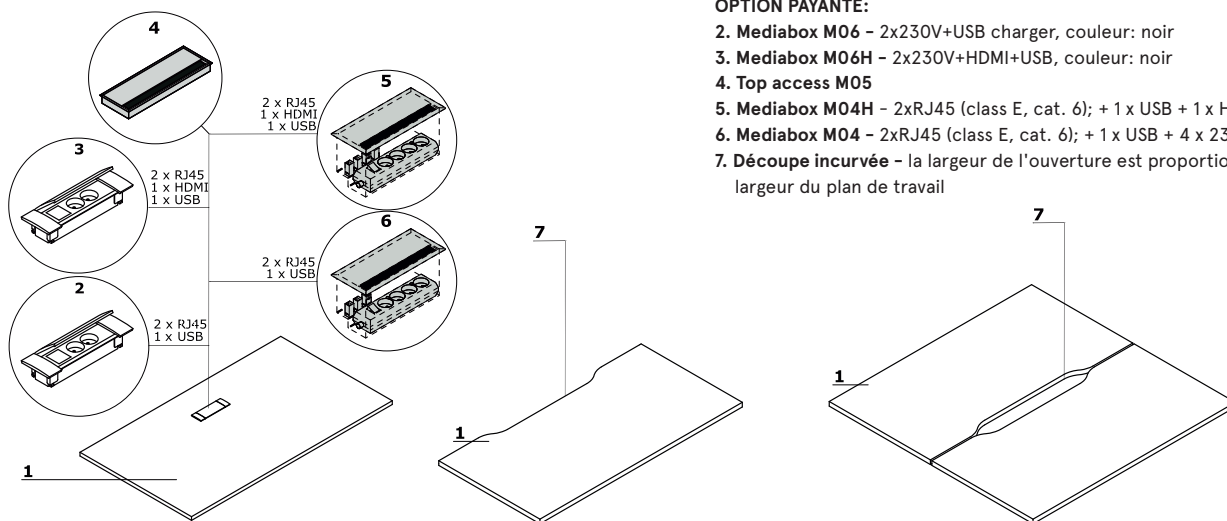

1. Plateau - mélaminé 18 mm, chants ABS

OPTION PAYANTE:

- 2. Mediabox M06 - 2x230V+USB charger, couleur: noir
- 3. Mediabox M06H - 2x230V+HDMI+USB, couleur: noir
- 4. Top access M05
- 5. Mediabox M04H - 2xRJ45 (class E, cat. 6); + 1 x USB + 1 x HDMI + 4 x 230V
- 6. Mediabox M04 - 2xRJ45 (class E, cat. 6); + 1 x USB + 4 x 230V
- 7. Découpe incurvée - la largeur de l'ouverture est proportionnelle à la largeur du plan de travail

Piètement

- 1. Pied - pied en bois - chêne, profil 80x40mm
- 2. Structure - aluminium anodisé, couleur : noir; distance entre le dessus et le cadre de 30 mm

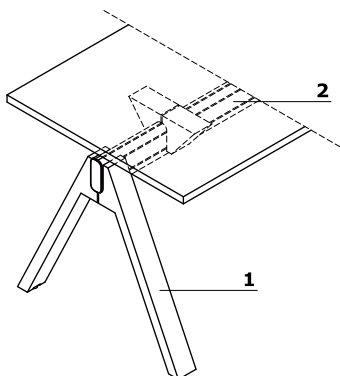

Extensions - pour bureaux bench

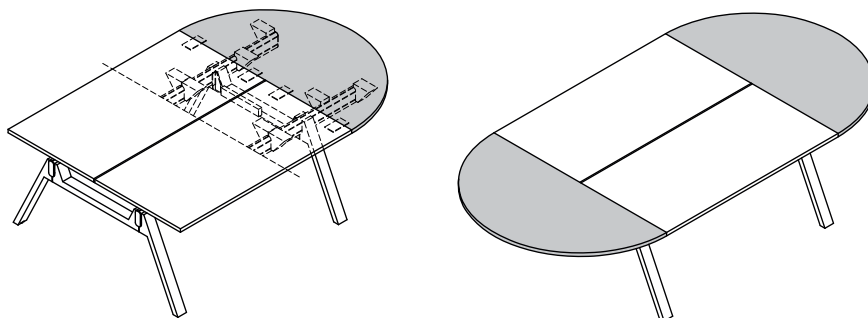

option avec plus-value

Viga M	Date 30.05.2023	Ces données sont valides à la date d'élaboration. Les évolutions des produits, si elles ne touchent pas les caractéristiques fondamentales, n'impliquent pas une mise à jour systématique de la fiche technique.	page 3/20 descriptif et composition
--------	--------------------	---	--

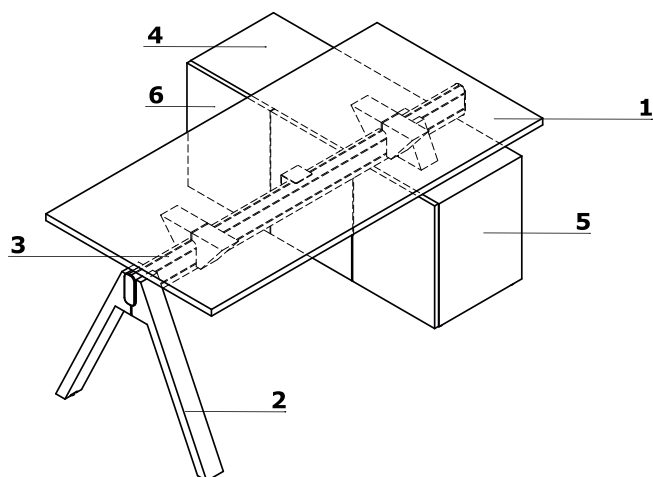
Bureaux sur meuble retour porteur

1. Plateau - mélaminé 18 mm, chants ABS
2. Pied - pied en bois - chêne, profil 80x40mm
3. Structure - aluminium anodisé, couleur : noir; distance entre le dessus et le cadre de 30 mm
4. Top - mélaminé 18 mm, chants ABS
5. Corps - mélaminé 18 mm, chants ABS
6. Façade - Systeme "Push-to-Open", mélamine 18mm, chants ABS

Bureaux de direction - plateau

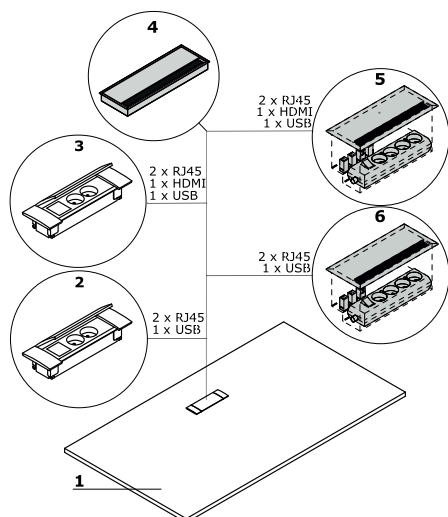

1. Plateau - mélaminé 28 mm, chants ABS

OPTION PAYANTE :

2. Mediabox M06 - 2x230V+USB charger, couleur: noir

3. Mediabox M06H - 2x230V+HDMI+USB, couleur: noir

4. Top access M05

5. Mediabox M04H - 2xRJ45 (class E, cat. 6); + 1 x USB + 1 x HDMI + 4 x 230V

6. Mediabox M04 - 2xRJ45 (class E, cat. 6); + 1 x USB + 4 x 230V

Piètement

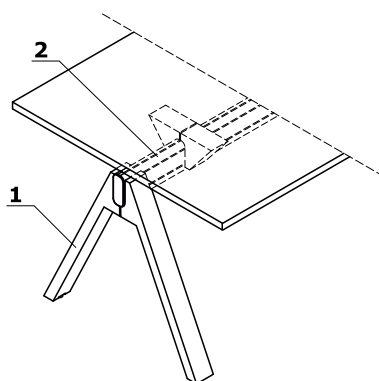

1. Pied - pied en bois - chêne, profil 80x40mm

2. Structure - aluminium anodisé, couleur : noir; distance entre le dessus et le cadre de 30 mm

Armoires et rangements

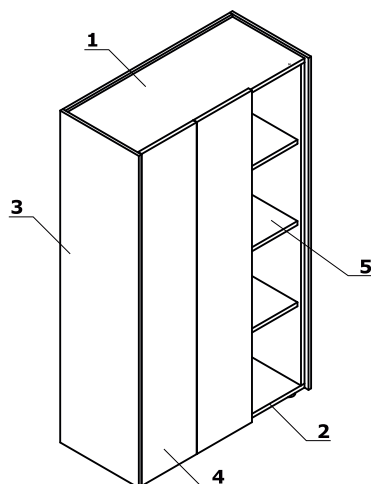

1. Top - mélaminé 18 mm, chants ABS

2. Base - mélaminé 18 mm, chants ABS

3. Corps extérieur - panneau mélaminé 12 mm

4. Façade - Systeme "Push-to-Open", mélamine 18 mm, chants ABS

5. Tablette - mélaminé 18 mm, protection contre les chutes accidentelles, chants ABS

Bureaux sur meuble retour porteur

1. **Plateau** - mélaminé 28 mm, chants ABS
2. **Voile de fond** - panneau mélaminé 12 mm; poignée - finition peinture poudre époxy, couleur: noir

CAISSON :

3. **Top** - mélaminé 18 mm, chants ABS
4. **Base** - mélaminé 18 mm, chants ABS
5. **Corps extérieur** - panneau mélaminé 12 mm
6. **Corps intérieur** - mélaminé 18 mm
7. **Façade** - panneau mélaminé 12 mm
8. **Tiroirs mélaminé** - glissières à billes, charge max 25 kg, extraction 100% serrure centralisée assure la fermeture de l'ensemble des tiroirs, amortisseur de fermeture
9. **Tablette** - mélaminé 18 mm, protection contre les chutes accidentelles, chants ABS

CRÉDENCE DE DIRECTION :

10. **Top** - mélaminé 18 mm, chants ABS
11. **Base** - mélaminé 18 mm, chants ABS
12. **Corps extérieur** - panneau mélaminé 12 mm
13. **Corps intérieur** - mélaminé 18 mm
14. **Portes coulissantes** - panneau mélaminé 18 +12 mm, fermeture silencieuse
15. **Tiroirs mélaminé** - glissières à billes, extraction 100% serrure centralisée assure la fermeture de l'ensemble des tiroirs, amortisseur de fermeture
16. **Serrure**

BUREAU AVEC MEUBLE RETOUR (MEUBLE AVEC RANGEMENTS DES DEUX CÔTÉS) :

17. **Top** - mélaminé 18 mm, chants ABS
18. **Base** - mélaminé 18 mm, chants ABS
19. **Corps extérieur** - panneau mélaminé 12 mm
20. **Corps intérieur** - mélaminé 18 mm
21. **Portes coulissantes** - panneau mélaminé 18 +12 mm, fermeture silencieuse
22. **Tiroirs mélaminé** - glissières à billes, extraction 100% serrure centralisée assure la fermeture de l'ensemble des tiroirs, amortisseur de fermeture
23. **Serrure**

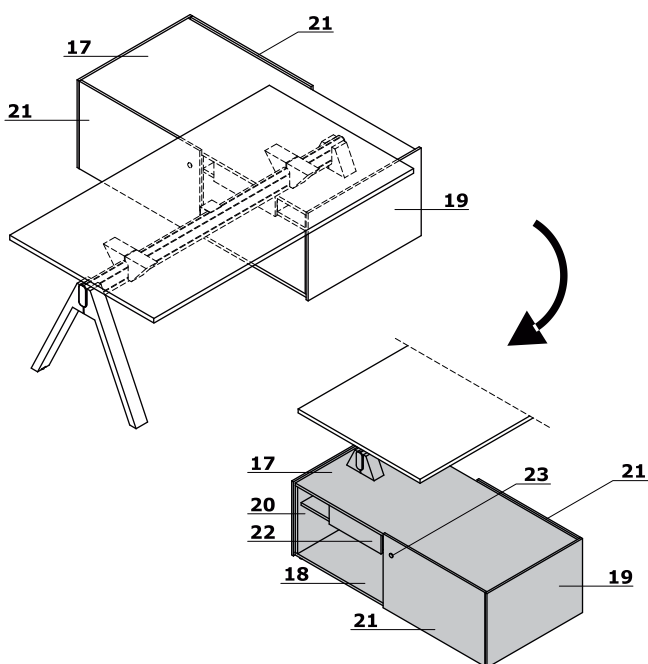
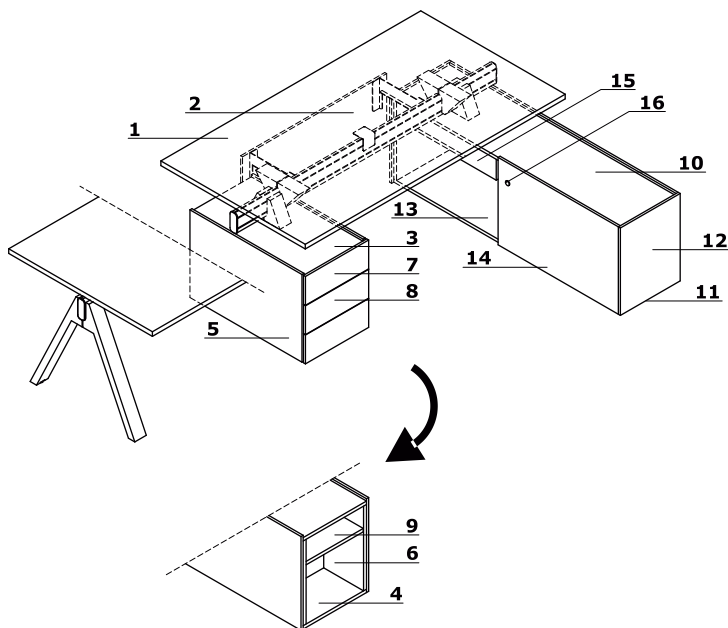

Caissons

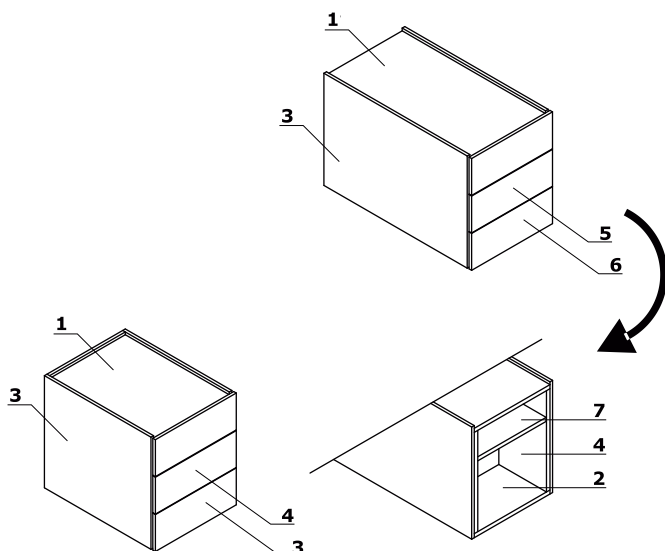

1. **Top** - mélaminé 18 mm, chants ABS
2. **Base** - mélaminé 18 mm, chants ABS
3. **Corps extérieur** - panneau mélaminé 12 mm
4. **Corps intérieur** - mélaminé 18 mm
5. **Façade** - panneau mélaminé 12 mm
6. **Tiroirs mélaminé** - glissières à billes, extraction 100% serrure centralisée assure la fermeture de l'ensemble des tiroirs, amortisseur de fermeture
7. **Tablette** - mélaminé 18 mm, protection contre les chutes accidentelles, chants ABS

Tables de réunion

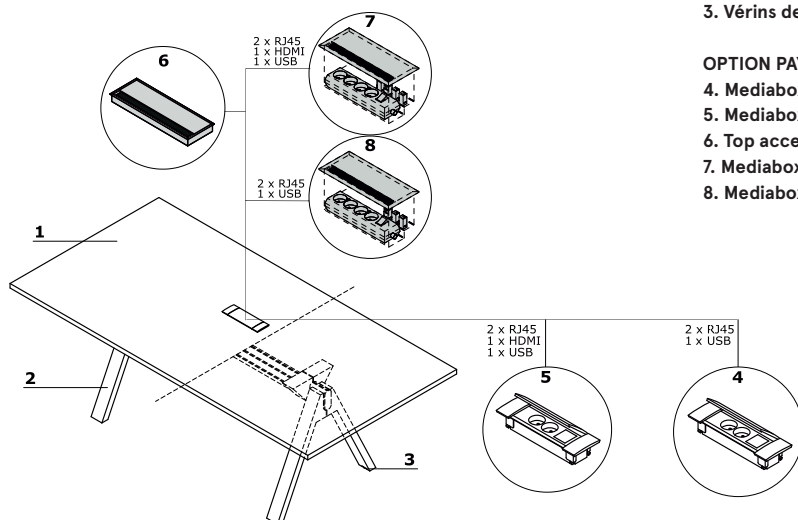

1. **Plateau** - mélaminé 18 mm, chants ABS
2. **Pied** - pied en bois - chêne, profil 80x40mm
3. **Vérins de réglage** - course de 5 mm

OPTION PAYANTE :

4. **Mediabox M06** - 2x230V+USB charger, couleur: noir
5. **Mediabox M06H** - 2x230V+HDMI+USB, couleur: noir
6. **Top access M05**
7. **Mediabox M04H** - 2xRJ45 (class E, cat. 6); + 1 x USB + 1 x HDMI + 4 x 230V
8. **Mediabox M04** - 2xRJ45 (class E, cat. 6); + 1 x USB + 4 x 230V

Emplacement mediabox

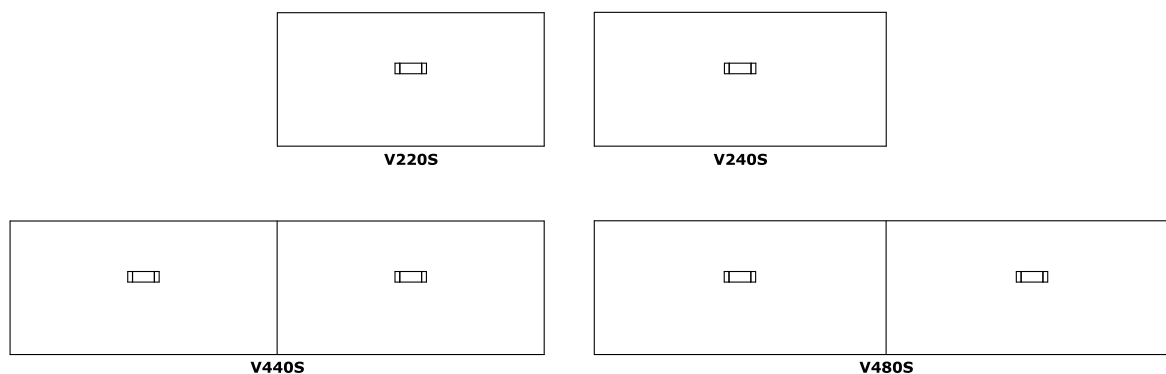

Tables hautes

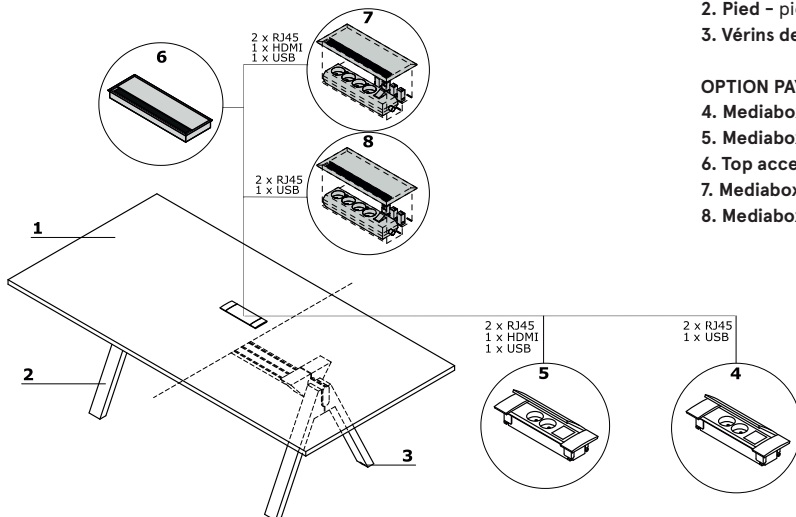

Bureaux droits *



V16M
1600 / 800 / 740
44.86 kg

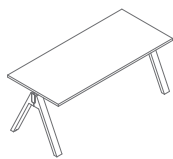

V18M
1800 / 800 / 740
48.79 kg

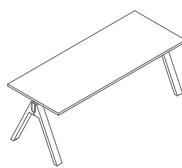

V20M
2000 / 800 / 740
52.72 kg

Benchs *

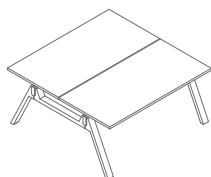

V216M
1600 / 1610 / 740
93.72 kg

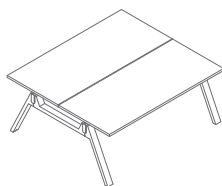

V218M
1800 / 1610 / 740
101.58 kg

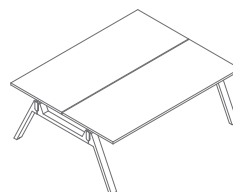

V220M
2000 / 1610 / 740
109.44 kg

Élément suivant - pour bureau droit *

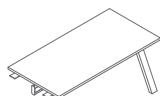

V16LM
1600 / 800 / 740
41.16 kg

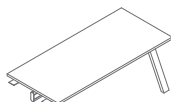

V18LM
1800 / 800 / 740
45.091 kg

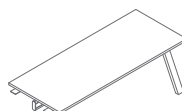

V20LM
2000 / 800 / 740
82.02 kg

Élément suivant - pour bench *

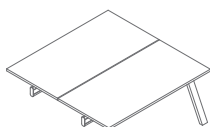

V216LM
1600 / 1610 / 740
87.72 kg

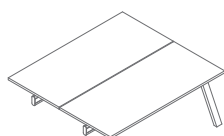

V218LM
1800 / 1610 / 740
95.58 kg

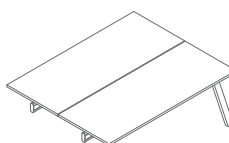

V220LM
2000 / 1610 / 740
103.44 kg

* Dimensions exprimées en millimètre : Largeur x Profondeur x Hauteur

Viga M	Date 30.05.2023	Ces données sont valides à la date d'élaboration. Les évolutions des produits, si elles ne touchent pas les caractéristiques fondamentales, n'impliquent pas une mise à jour systématique de la fiche technique.	page 9/20
			synoptique

Bureau avec meuble retour *

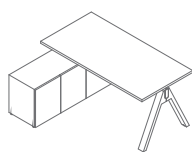

V163LM
1600 / 1300 / 740
85,36 kg

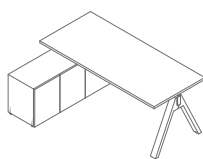

V183LM
1800 / 1300 / 740
89,29 kg

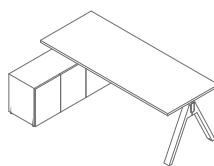

V203LM
2000 / 1300 / 740
93,22 kg

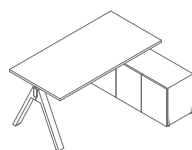

V163PM
1600 / 1300 / 740
85,36 kg

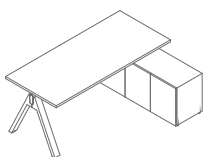

V183PM
1800 / 1300 / 740
89,29 kg

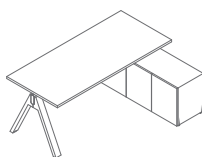

V203PM
2000 / 1300 / 740
93,22 kg

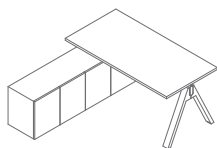

V164LM
1600 / 1700 / 740
96,36 kg

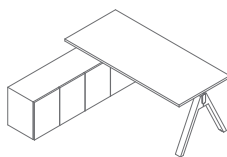

V184LM
1800 / 1700 / 740
100,29 kg

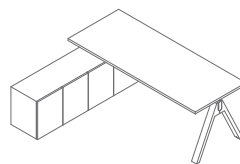

V204LM
2000 / 1700 / 740
104,22 kg

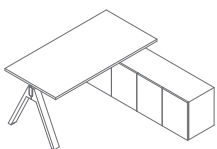

V164PM
1600 / 1700 / 740
96,36 kg

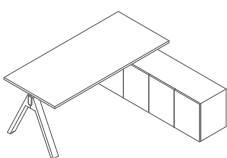

V184PM
1800 / 1700 / 740
100,29 kg

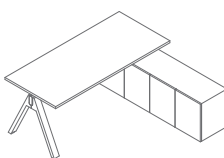

V204PM
2000 / 1700 / 740
104,22 kg

* Dimensions exprimées en millimètre : Largeur x Profondeur x Hauteur

Bureau avec meuble retour *

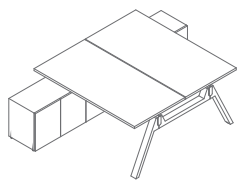

V1623M
1600 / 2400 / 740
178.72 kg

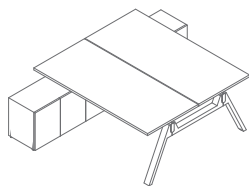

V1823M
1800 / 2400 / 740
186.58 kg

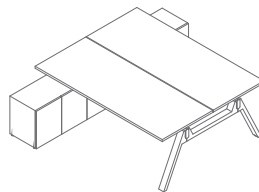

V2023M
2000 / 2400 / 740
194.44 kg

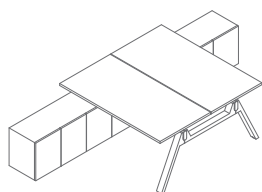

V1624M
1600 / 3200 / 740
200.72 kg

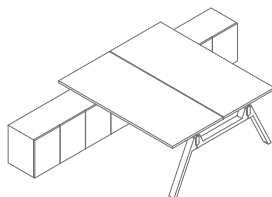

V1824M
1800 / 3200 / 740
208.58 kg

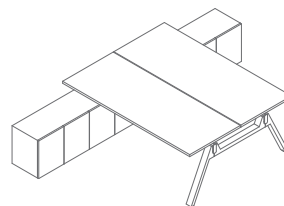

V2024M
2000 / 3200 / 740
216.44 kg

Accessoires *

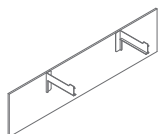

V16BM
1600 / 340 / 400
11 kg

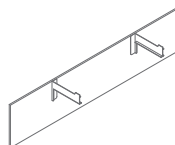

V18BM
1800 / 340 / 400
12 kg

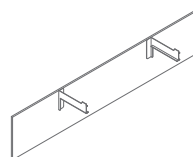

V20BM
2000 / 340 / 400
12.5 kg

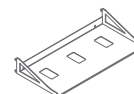

V34
550 / 280 / 85
3 kg

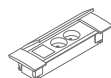

M06
245 / 80 / 50
1 kg

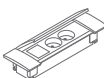

M06H
245 / 80 / 50
1 kg

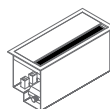

M04
275 / 120 / 140
1.6 kg

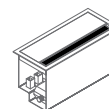

M04H
275 / 120 / 140
2 kg

* Dimensions exprimées en millimètre : Largeur x Profondeur x Hauteur

Accessoires *

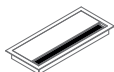

M05
275 / 120 / 25
0.3 kg

Bureaux *



V01M
1800 / 1000 / 740
55.79 kg

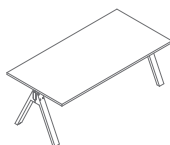

V02M
2000 / 1000 / 740
60.22 kg

Bureaux sur meuble retour porteur *

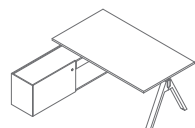

V03LM
1800 / 1800 / 740
115.79 kg

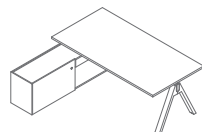

V04LM
2000 / 1800 / 740
120.22 kg

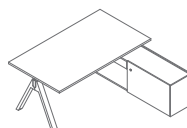

V03PM
1800 / 1800 / 740
115.79 kg

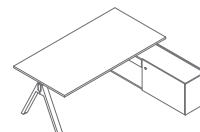

V04PM
2000 / 1800 / 740
120.22 kg

Bureau avec meuble retour – meuble avec rangements des deux côtés *

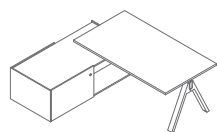

V05LM
1800 / 1000 / 740
149.79 kg

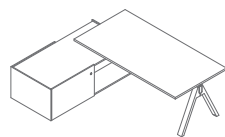

V06LM
2000 / 1000 / 740
154.22 kg

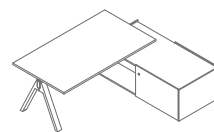

V05PM
1800 / 1000 / 740
149.79 kg

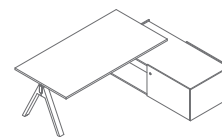

V06PM
2000 / 1000 / 740
154.22 kg

* Dimensions exprimées en millimètre : Largeur x Profondeur x Hauteur

Bureaux avec caisson porteur *

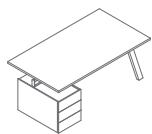

V07LM
1800 / 1000 / 740
135.29 kg

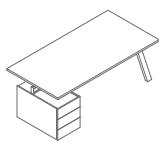

V08LM
2000 / 1000 / 740
102.72 kg

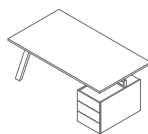

V07PM
1800 / 1000 / 740
135.29 kg

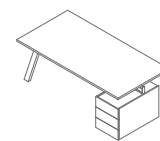

V08PM
2000 / 1000 / 740
102.72 kg

Bureaux avec meuble retour et caisson porteur *

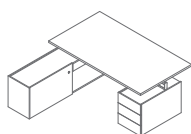

V09LM
1800 / 1800 / 740
158.296 kg

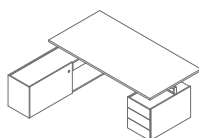

V10LM
2000 / 1800 / 740
203.22 kg

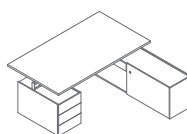

V09PM
1800 / 1800 / 740
158.29 kg

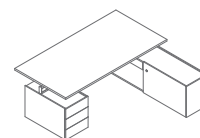

V10PM
2000 / 1800 / 740
203.22 kg

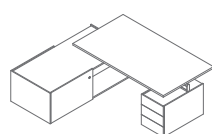

V37LM
2144 / 1800 / 740
192.29 kg

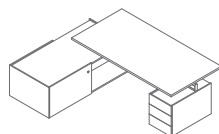

V38LM
2344 / 1800 / 740
196.72 kg

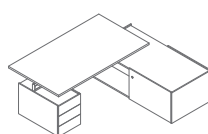

V37PM
2144 / 1800 / 740
192.29 kg

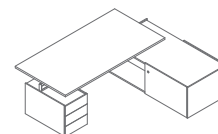

V138PM
2344 / 1800 / 740
196.72 kg

Crédence de direction *

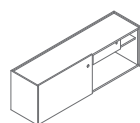

V35M
1602 / 416 / 545
62.5 kg

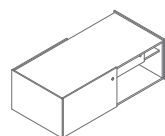

V36M
1602 / 784 / 545
96.5 kg

* Dimensions exprimées en millimètre : Largeur x Profondeur x Hauteur

Armoires et rangements *

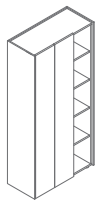

V22M
928 / 424 / 1944
110,5 kg

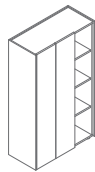

V23M
928 / 424 / 1565
82 kg



V24M
828 / 424 / 807
56 kg

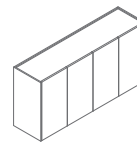

V25M
1628 / 424 / 807
104 kg



V26M
828 / 424 / 807
44 kg

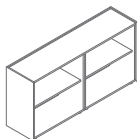

V27M
1628 / 424 / 807
79 kg



V28M
828 / 424 / 807
54 kg

Caissons *

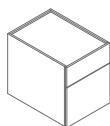

V12KM
438 / 600 / 545
35 kg

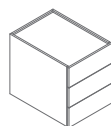

V13KM
438 / 600 / 545
35 kg

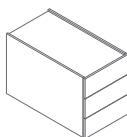

V14KM
438 / 800 / 545
45 kg

Éléments supplémentaires *

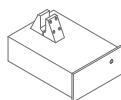

V11M
436 / 600 / 216
16,5 kg

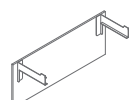

V10BM
1000 / 340 / 400
8 kg

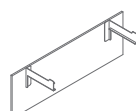

V12BM
1200 / 340 / 400
8,5 kg

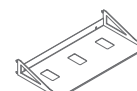

V34
550 / 280 / 85
3 kg

* Dimensions exprimées en millimètre : Largeur x Profondeur x Hauteur

Viga M	Date 30.05.2023	Ces données sont valides à la date d'élaboration. Les évolutions des produits, si elles ne touchent pas les caractéristiques fondamentales, n'impliquent pas une mise à jour systématique de la fiche technique.	page 14/20
			synoptique

Éléments supplémentaires *

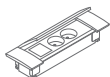

M06

245 / 80 / 50
1 kg

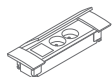

M06H

245 / 80 / 50
1 kg

* Dimensions exprimées en millimètre : Largeur x Profondeur x Hauteur

Viga M	Date 30.05.2023	Ces données sont valides à la date d'élaboration. Les évolutions des produits, si elles ne touchent pas les caractéristiques fondamentales, n'impliquent pas une mise à jour systématique de la fiche technique.	page 15/20
			synoptique

Tables de réunion *



V220SM
2200 / 1100 / 740
65.44 kg



V240SM
2400 / 1100 / 740
123.1270.36

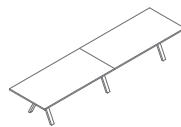

V440SM
4400 / 1100 / 740
130.88 kg

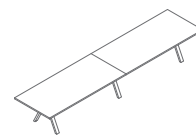

V480SM
4800 / 1100 / 740
245.74 kg

Tables hautes *



V169M
1600 / 800 / 900
73.36 kg



V189M
1800 / 800 / 900
50.29 kg



V209M
2000 / 800 / 900
54.22 kg



V1611M
1600 / 800 / 1100
74.36 kg



V1811M
1800 / 800 / 1100
81.29 kg



V2011M
2000 / 800 / 1100
88.22 kg



V1619M
1600 / 1000 / 900
81.36 kg



V1819M
1800 / 1000 / 900
90.29 kg



V2019M
2000 / 1000 / 900
105.22 kg

* Dimensions exprimées en millimètre : Largeur x Profondeur x Hauteur

Tables hautes *



V16111M
1600 / 1000 / 1100
51.36 kg



V18111M
1800 / 1000 / 1100
56.29 kg

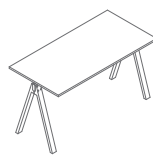

V20111M
2000 / 1000 / 1100
106.22 kg

Éléments a multiplier les postes *



V169LM
1600 / 800 / 900
41.96 kg



V189LM
1800 / 800 / 900
45.89 kg



V209LM
2000 / 800 / 900
82.82 kg



V1611LM
1600 / 800 / 1100
69.66 kg



V1811LM
1800 / 800 / 1100
76.59 kg



V2011LM
2000 / 800 / 1100
83.52 kg



V1619LM
1600 / 1000 / 900
76.96 kg



V1819LM
1800 / 1000 / 900
85.89 kg



V2019LM
2000 / 1000 / 900
100.82 kg

* Dimensions exprimées en millimètre : Largeur x Profondeur x Hauteur

Éléments a multiplier les postes *



V16111LM
1600 / 1000 / 1100
46.66 kg



V18111LM
1800 / 1000 / 1100
51.59 kg



V20111LM
2000 / 1000 / 1100
59.52 kg

Accessoires *

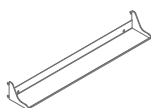

V21
700 / 120 / 85
1.8 kg

* Dimensions exprimées en millimètre : Largeur x Profondeur x Hauteur

Viga M	Date 30.05.2023	Ces données sont valides à la date d'élaboration. Les évolutions des produits, si elles ne touchent pas les caractéristiques fondamentales, n'impliquent pas une mise à jour systématique de la fiche technique.	page 18/20
			synoptique

Bureaux, bureaux de direction, crédence de direction, tables de réunion, tables hautes

Plateau



08 Noir

31 Chêne
canadien

64 Cacao

106 Noyer



167 Chêne gris

168 Chêne naturel

171 Noyer foncé

Pied

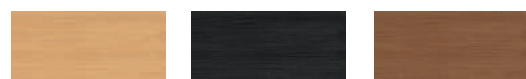

181 Chêne naturel

182 Chêne noir

191 Chêne cuivré

Éléments complémentaires

Mediabox

M115 Noir semi-
mat RAL9005

Bureaux sur meuble retour porteur

Plateau, panneau du haut et arrière, corps intérieur, façade



08 Noir

31 Chêne
canadien

64 Cacao

106 Noyer



167 Chêne gris

168 Chêne naturel

171 Noyer foncé

Côtés du meuble



08 Noir

Pied

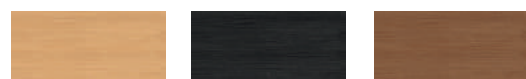

181 Chêne naturel

182 Chêne noir

191 Chêne cuivré

Éléments supplémentaires

Bloc tiroirs suspendu, voile de fond

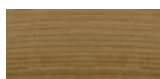

08 Noir

31 Chêne
canadien

64 Cacao

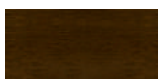

106 Noyer



167 Chêne gris



168 Chêne naturel



171 Noyer foncé

Mediabox

M115 Noir semi-
mat RAL9005

Armoires et rangements

Plateau, Côtés du meuble



08 Noir

Corps extérieur, corps intérieur, façade

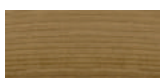

08 Noir

31 Chêne
canadien

64 Cacao



106 Noyer



167 Chêne gris



168 Chêne naturel



171 Noyer foncé

Caissons

Plateau, façade, corps intérieur

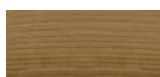

08 Noir

31 Chêne
canadien

64 Cacao



106 Noyer



167 Chêne gris

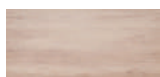

168 Chêne naturel



171 Noyer foncé

Corps extérieur



08 Noir