



STRIPES 2008

The bench, a collective seating furniture by nature, lies at the core of the Stripes sofa concept. From slats to upholstered covers, this piece of furniture embodies with style the archetype. It also offers a unique touch thanks to the back cushion.

Modules can be linear, curvilinear, closed, with adjustable back height, with or without armrest.

They can offer various combinations: face to face, side by side depending on orthogonal and hexagonal stripes. The sofa becomes a work station when adding a shelf on the backrest at the rear. Therefore, the combined augmented modules provide ideal configurations for multimedia collaborative space.

When used independently or combined in a flexible manner, Stripes components allow for multipurpose work environments suitable for all staff to perform their tasks.

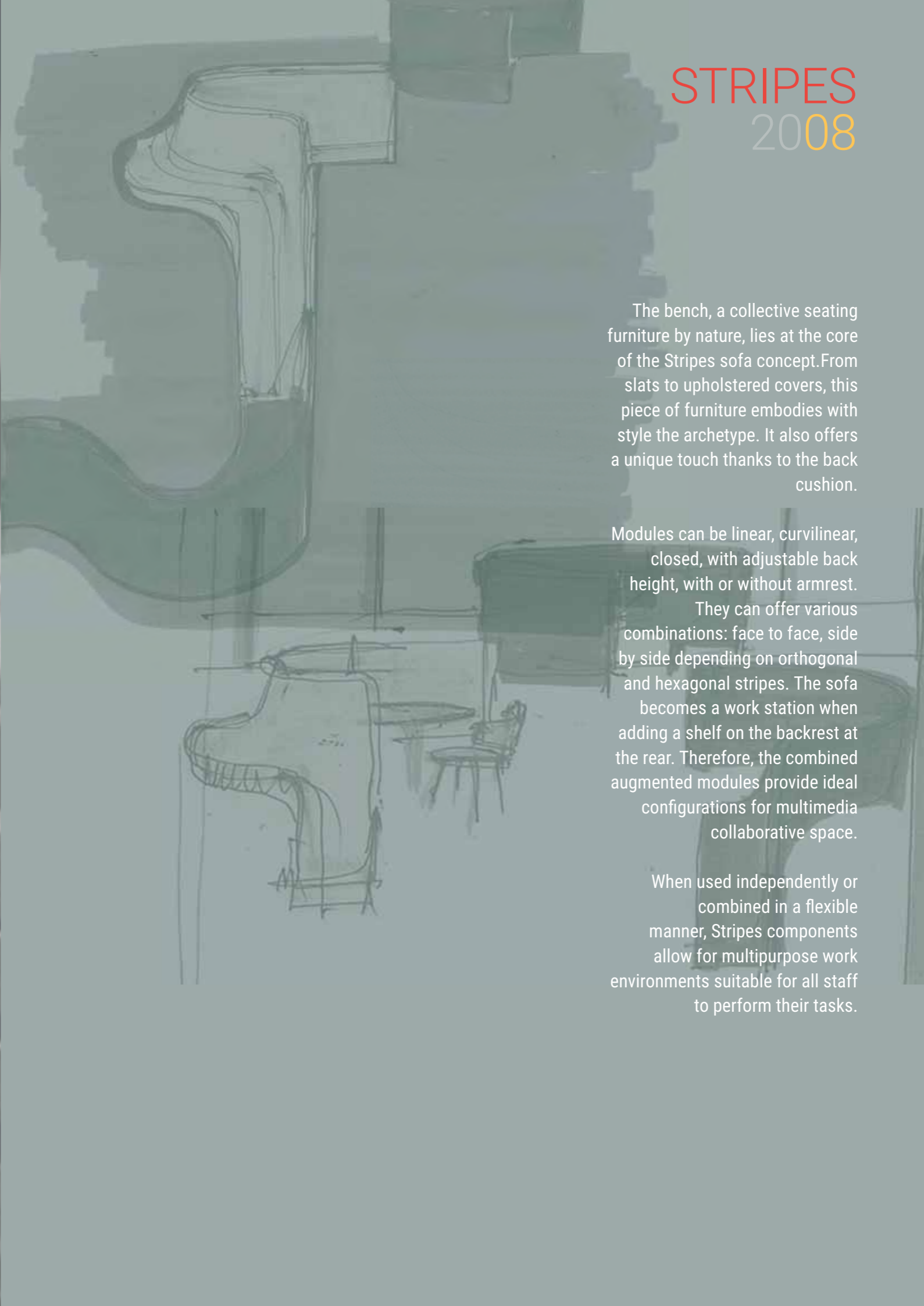

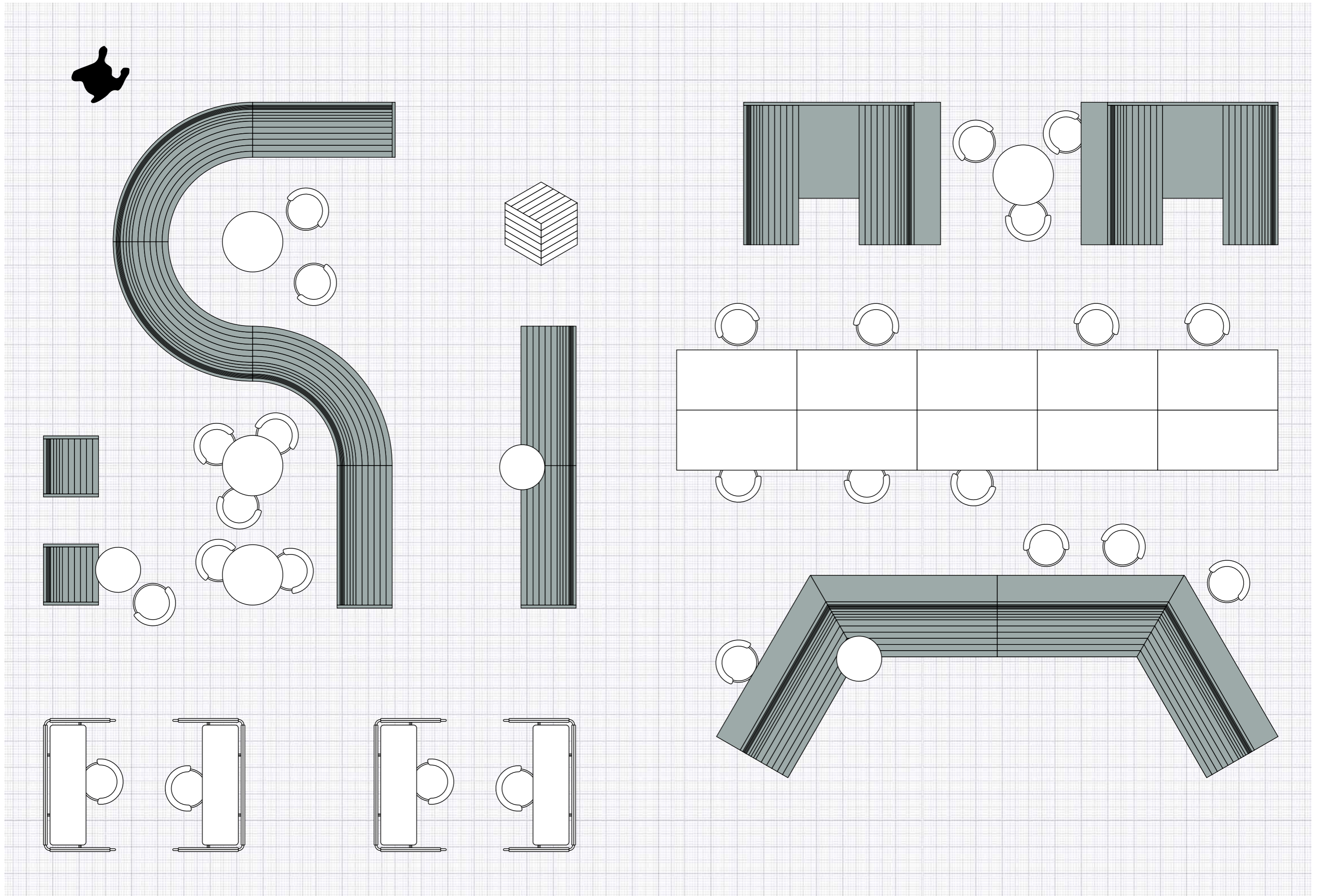









STRIPES sofa
9SS305 cm 145x73x133h
Fabric: cat. B art. Camira Xtreme Plus col. Panama YS079
Metal base: OPM1 shiny chrome metal



STRIPES customized sofa
cm 900x73x133h
Leather: cat. Super art. Dollaro col. 7290
Metal base: RAL 9006 white aluminium painted





STRIPES sofa
9SS208 cm 185x73x133h
Fabric:
External side: cat. E art. Camira Blazer II col. Silverdale CUZ28
Seat: cat. B art. Camira Xtreme Plus col. Diablo YS101
Backrest: cat. B art. Camira Xtreme Plus col. Panama YS079
Metal base: OPM1 shiny chrome metal

STRIPES composition A**9SS614 cm 225/185x73x101h**

Fabric: cat. B art. Gabriel Atlantic col. 64116

Metal base: OPM6 RAL 9017 traffic black painted

9SS809 low shelves

HPL colour 1661

Metal base: OPM6 RAL 9017 traffic black painted

Cushions

9RL112 cm 63x33

Fabric: cat. B art. Gabriel Atlantic col. 62048

9SS805 Belux lamps**9SS802** Schulte Evoline sockets**9SS801** Mobile socket**PIVOT** swivel chair**9PIV101 cm 55.5x54x80h**

Fabric: cat. B art. Gabriel Atlantic col. 64116 red and 62048 green

Oak structure in natural oak OPR4

PIVOT table**7PIV101 ø cm 60x43/61h**

OPR4 natural oak

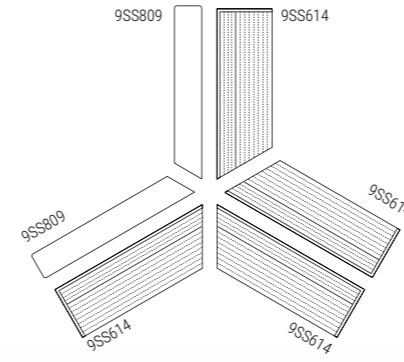



STRIPES composition A
9SS614 cm 225/185x73x101h
 Fabric: cat. B art. Gabriel Atlantic col. 64116
 Metal base: OPM6 RAL 9017 traffic black painted
9SS809 low shelves
 HPL colour 1661
 Metal base: OPM6 RAL 9017 traffic black painted

Cushions
9RL112 cm 63x33
 Fabric: cat. B art. Gabriel Atlantic col. 62048

9SS805 Belux lamps
9SS802 Schulte Evoline sockets
9SS801 Mobile socket

PIVOT swivel chair
9PIV101 cm 55.5x54x80h
 Fabric: cat. B art. Gabriel Atlantic
 col. 64116 red and 62048 green
 Oak structure in natural oak OPR4

PIVOT table
7PIV101 ø cm 60x43/61h
 OPR4 natural oak

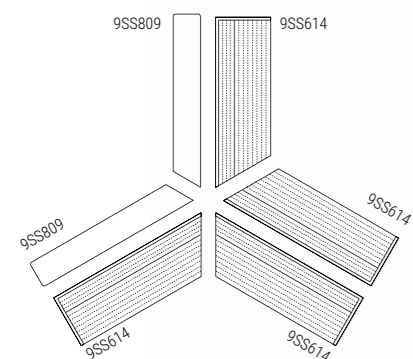

STRIPES curved composition B ø cm 370
9SS908 cm 73x133h
9SS907 cm 73x133h
Fabric: cat. B art. Gabriel Atlantic col. 64116
Metal base: OPM6 RAL 9017 traffic black painted

Cushions
9RL112 cm 63x33
Fabric: cat. B art. Gabriel Atlantic col. 64116 and 61163

PIVOT table
7PIV101 ø cm 60x43/61h
OPR4 natural oak

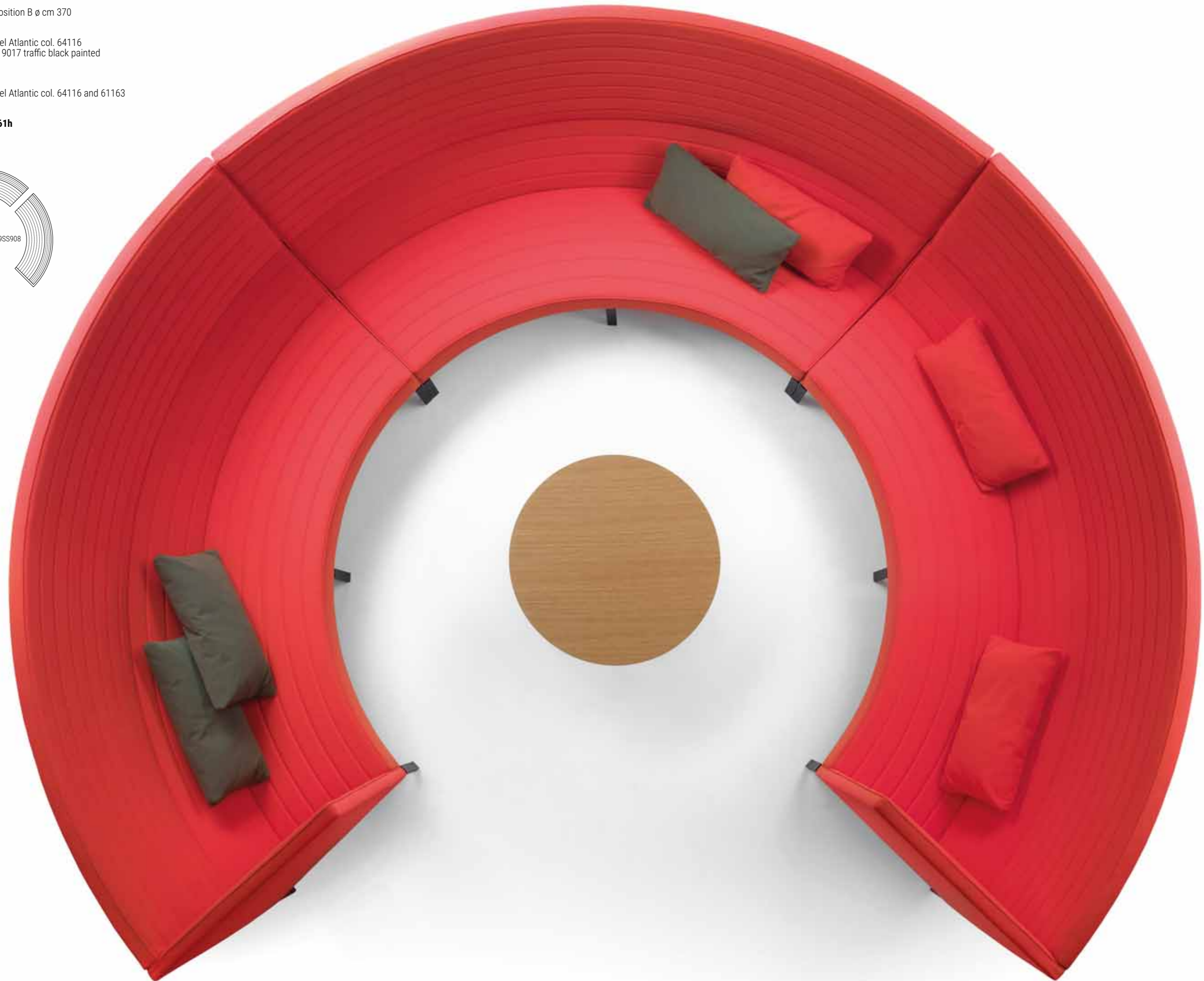
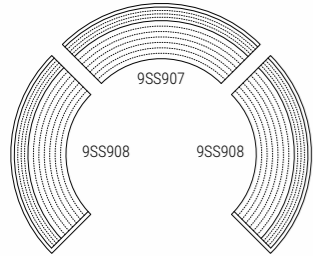

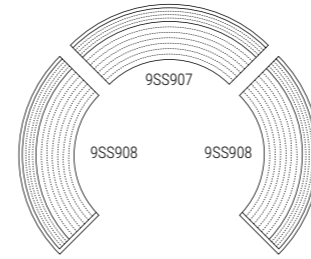

STRIPES curved composition B \varnothing cm 370
9SS908 cm 73x133h
9SS907 cm 73x133h
 Fabric: cat. B art. Gabriel Atlantic col. 64116
 Metal base: OPM6 RAL 9017 traffic black painted

Cushions
9RL112 cm 63x33
 Fabric: cat. B art. Gabriel Atlantic col. 64116 and 61163

PIVOT table
7PIV101 \varnothing cm 60x43/61h
 OPR4 natural oak





STRIPES composition C
9SS208 cm 185x73x133h
 Fabric: cat. B art. Gabriel Atlantic col. 61163
 Metal base: OPM6 RAL 9017 traffic black painted
9SS404X table cm 82x133x133h
9SS808 high shelf
 HPL colour 1661

Cushions
9RL112 cm 63x66
 Fabric: cat. B art. Gabriel Atlantic col. 66086

9SS803 Bachmann Power Frame electric module
9SS804 Mobile lamp
9SS805 Belux lamp
9SS802 Schulte Evoline socket

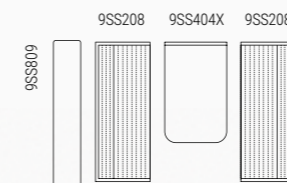
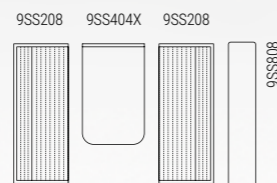

STRIPES composition C
9SS208 cm 185x73x133h
 Fabric: cat. B art. Gabriel Atlantic col. 61078
 Metal base: OPM6 RAL 9017 traffic black painted
9SS404X table cm 82x133x133h
9SS809 low shelf
 HPL colour 1661

Cushions
9RL112 cm 63x66
 Fabric: cat. B art. Gabriel Atlantic col. 66086

9SS803 Bachmann Power Frame electric module
9SS804 Mobile lamp
9SS805 Belux lamp
9SS802 Schulte Evoline socket

PIVOT swivel chair
9PIV101 cm 55.5x54x80h
 Fabric: cat. B art. Gabriel Atlantic col. 66086
 Oak structure in natural oak OPR4

STRIPES composition C
9SS208 cm 185x73x133h
 Fabric: cat. B art. Gabriel Atlantic col. 61078
 Metal base: OPM6 RAL 9017 traffic black painted
9SS809 low shelf
9SS404X table **cm 82x133x133h**
 HPL colour 1661

Cushions
9RL112 cm 63x66
 Fabric: cat. B art. Gabriel Atlantic col. 66086

9SS803 Bachmann Power Frame electric module
9SS804 Mobile lamp
9SS805 Belux lamp
9SS802 Schulte Evoline socket

PIVOT swivel chair
9PIV101 cm 55.5x54x80h
 Fabric: cat. B art. Gabriel Atlantic col. 66086
 Oak structure in natural oak OPR4

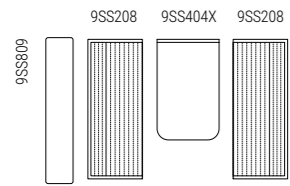

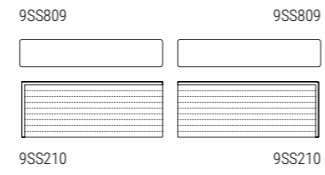

STRIPES composition D
9SS210 cm 185x73x101h
 Fabric: cat. B art. Gabriel Atlantic col. 61078
 Metal base: OPM6 RAL 9017 traffic black painted
9SS809 low shelves
 HPL colour 1661

9SS806 Mobile shelf
9SS805 Belux lamps
9SS801 Mobile socket

PIVOT swivel chair
9PIV101 cm 55.5x54x80h
 Fabric: cat. B art. Gabriel Atlantic
 col. 64116 red and 60063 beige
 Oak structure in natural oak OPR4

PIVOT table
7PIV101 ø cm 60x43/61h
 OPR4 natural oak



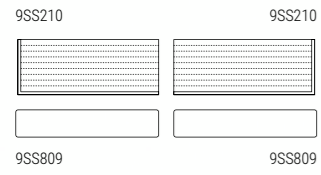

STRIPES composition D
9SS210 cm 185x73x101h
 Fabric: cat. B art. Gabriel Atlantic col. 61078
 Metal base: OPM6 RAL 9017 traffic black painted
9SS809 low shelf
 HPL colour 1661

9SS806 Mobile shelf
9SS805 Belux lamps
9SS801 Mobile socket

PIVOT swivel chair
9PIV101 cm 55.5x54x80h
 Fabric: cat. B art. Gabriel Atlantic
 col. 64116 red, 60063 beige and 61163 brown
 Oak structure in natural oak OPR4

PIVOT table
7PIV101 ø cm 60x43/61h
 OPR4 natural oak

PIVOT table
7PIV102 ø cm 78x43/74h
 OPR4 natural oak



STRIPES composition E**9SS401 cm 73x73x133h**

Fabric: cat. B art. Gabriel Atlantic col. 60063 beige

Metal base: OPM6 RAL 9017 traffic black painted

9SS405X table cm 82x55x133h

HPL colour 1661

STRIPES composition F**9SS610 cm 255x73x133h**

Fabric: cat. B art. Gabriel Atlantic col. 60063 beige

Metal base: OPM6 RAL 9017 traffic black painted

9SS808 high shelf cm 36x104

HPL colour 1661

Cushions **9RL112 cm 63x33**

Fabric: cat. B art. Gabriel Atlantic col. 61163

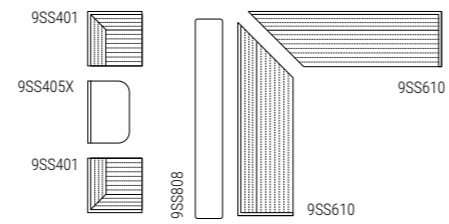
9SS805 Belux lamp**PIVOT** swivel armchairs**9PIV101 cm 55.5x54x80h**

Fabric: cat. B art. Atlantic col. 60063 and 61163

PIVOT tables**7PIV101 ø cm 60x43/61****7PIV102 ø cm 78x43/74h**

OPR4 natural oak





STRIPES sofa with roof
9SS924 cm 185x73x183h
Fabric: cat. B Gabriel Atlantic col. 60063 beige
Metal base: OPM6 RAL 9017 traffic black painted

PIVOT table
7PIV101 ø cm 60x43/61h
OPR4 natural oak





STRIPES sofa
9SS305 cm 145x73x133h
Fabric: cat. E art. Camira Blazer col. Surrey CUZ1E
Metal base: OPM6 RAL 9017 traffic black painted
9SS807 Bachmann Power Frame electric module
9SS810 RAL 9017 traffic black painted mobile writing shelf

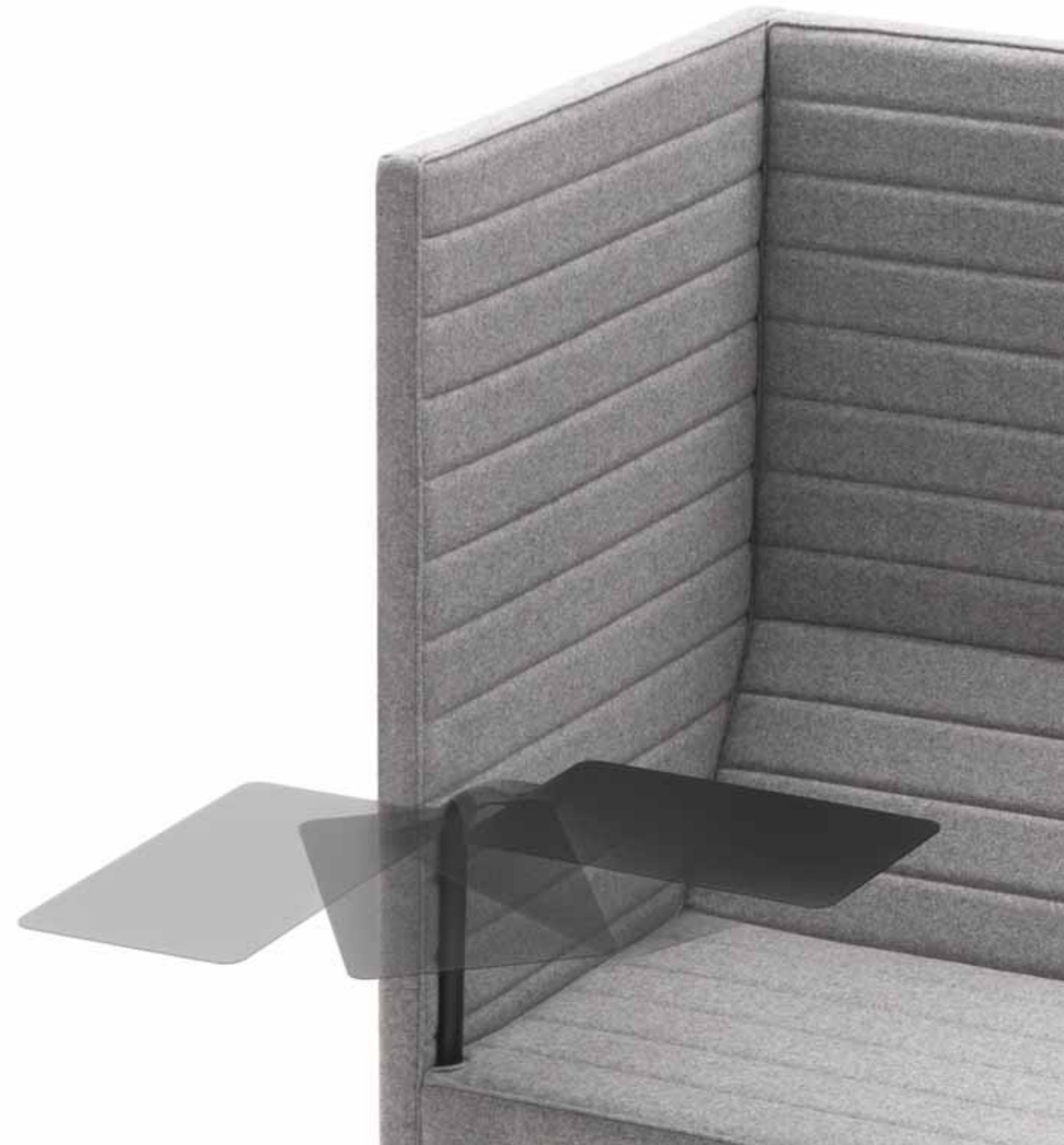



STRIPES composition G
9SS401 cm 73x73x133h
 Fabric: cat. E art. Camira Blazer col. Silcoates CUZ30
 Metal base: RAL 9006 white aluminium painted
9SS403X table cm 73x41x133h
 White melamine

9SS803 Bachmann Power Frame electric module



STRIPES composition H
9SS401 cm 73x73x133h
 Fabric: cat. E Camira Blazer col. Surrey CUZ1E
 Metal base: RAL 9006 white aluminium painted
9SS402X table cm 82x55x133h
 White melamine

9SS803 Bachmann Power Frame electric module

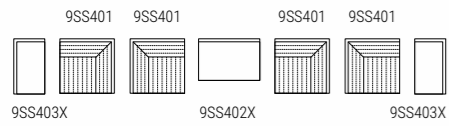

Stripes composition made of 2 compositions "G" and 1 composition "H", as described above.



STRIPES sofa without arms
9SS201 cm 145x73x101h with vertical quilting
9SS101 bench cm 145x73x42,5h with vertical quilting
 Fabric: cat. E art. Camira Blazer col. Edinburgh CUZ1Y
 Metal base: OPM6 RAL 9017 traffic black painted

STRIPES
9SS202 cm 145x73x101h sofa with 1 arm
9SS101 bench cm 145x73x42,5h with vertical quilting
9SS101 bench cm 145x73x42,5h
 Fabric: cat. E art. Camira blazer col. Bryanstom CUZ53
 Metal base: OPM6 RAL 9017 traffic black painted

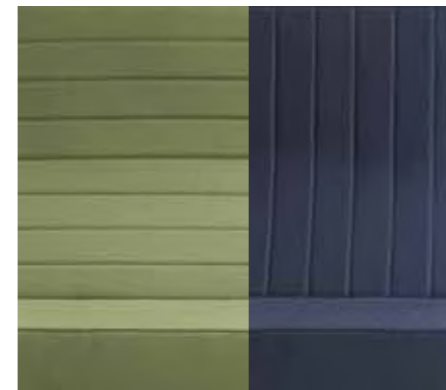

Stripes is available with horizontal and, on demand, with vertical quilting.



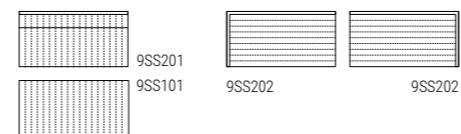

STRIPES sofas without arms
9SS201 cm 145x73x101h with vertical quilting
9SS101 bench cm 145x73x42.5h with vertical quilting
 Fabric: cat. E art. Camira Blazer col. Edinburgh CUZ1Y
 Metal base: OPM6 RAL 9017 traffic black painted

STRIPES sofas with 1 arm
9SS202 cm 145x73x101h
 Fabric: cat. E art. Camira blazer col. Bryanstom CUZ53
 Metal base: OPM6 RAL 9017 traffic black painted





STRIPES sofa
9SS204 cm 145x73x86h
Fabric: cat. E art. Camira blazer col. Bryanstom CUZ53
Metal base: RAL 9006 white aluminium painted

PIVOT swivel chair
9PIV101 cm 55.5x54x80h
Fabric: cat. E art. Camira Blazer col. Silverdale CUZ28
Oak structure in natural oak OPR4

PIVOT table
7PIV101 ø cm 60x43/61h
OPR4 natural oak





STRIPES composition J
9SS614 cm 225x73x101h with an angle of 60°
9SS627 cm 265x73x101h with an angle of 60°
 Fabric: cat. E art. Camira Blazer col. Surrey CUZ1E
 Metal base: OPM6 RAL 9017 traffic black painted
9SS809 low shelves
 HPL colour 1661

PIVOT swivel chair
9PIV101 cm 55.5x54x80h
 Fabric: cat. E art. Camira Blazer col. Surrey CUZ1E
 Oak structure in natural oak OPR4

PIVOT table
7PIV101 ø cm 60x43/61h
 OPR4 natural oak

PIVOT table
7PIV102 ø cm 78x43/74h
 OPR4 natural oak

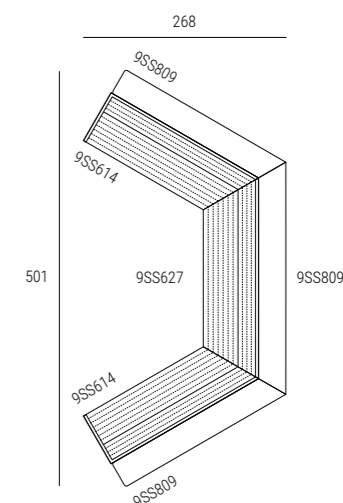

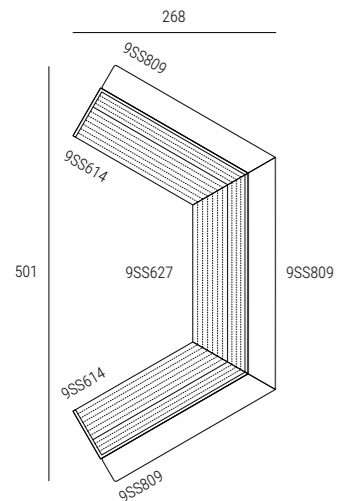

STRIPES composition J
9SS614 cm 225x73x101h with an angle of 60°
9SS627 cm 265x73x101h with an angle of 60°
 Fabric: cat. E art. Camira Blazer col. Surrey CUZ1E
 Metal base: OPM6 RAL 9017 traffic black painted
9SS809 low shelves
 HPL colour 1661

PIVOT swivel chair
9PIV101 cm 55.5x54x80h
 Fabric: cat. E art. Camira Blazer col. Surrey CUZ1E
 Oak structure in natural oak OPR4

PIVOT table
7PIV101 ø cm 60x43/61h
 OPR4 natural oak

PIVOT table
7PIV102 ø cm 78x43/74h
 OPR4 natural oak

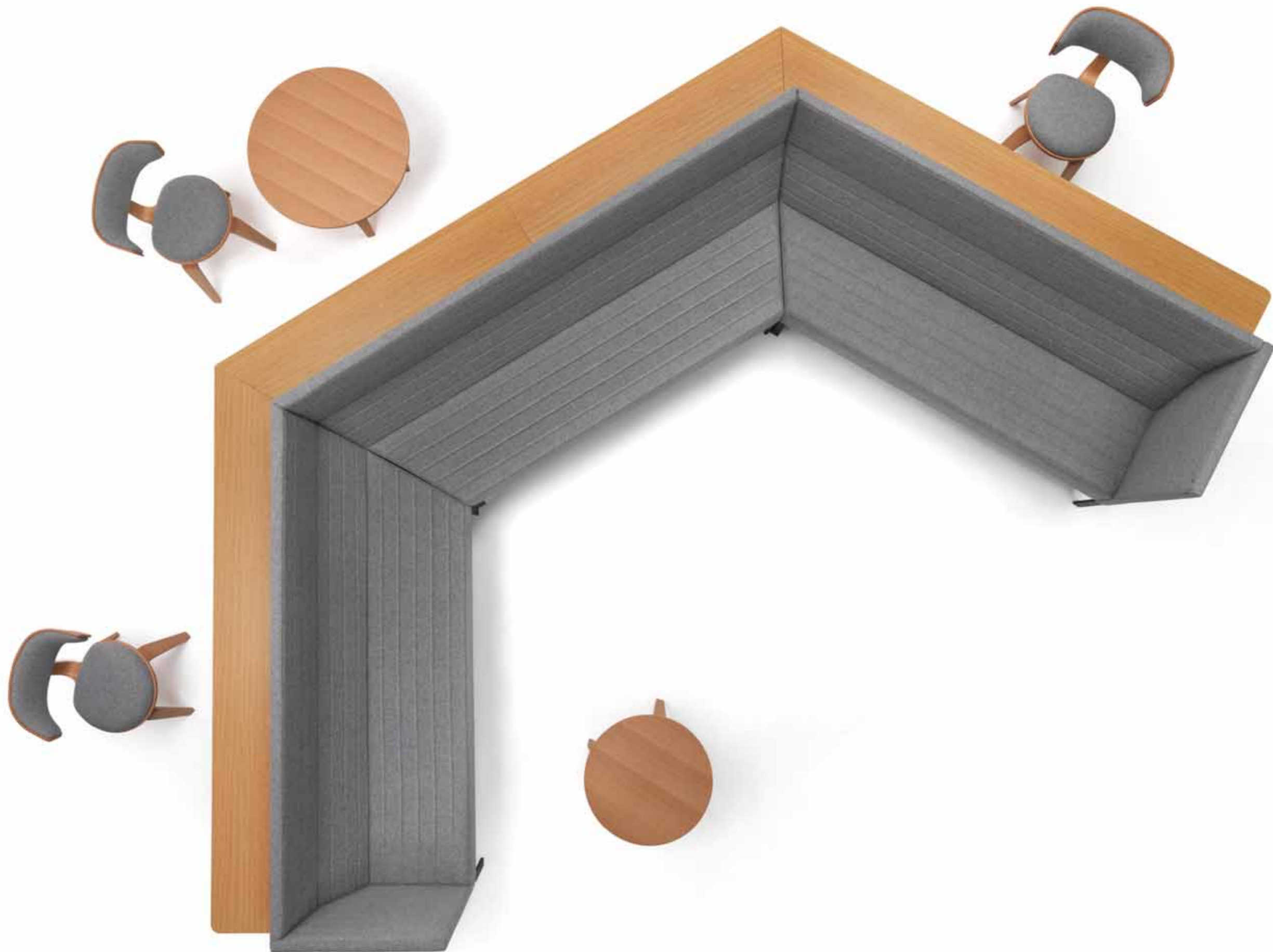

STRIPES composition M cm 161x552
9SS925 cm 73x42,5h
Fabric: cat. B art. Gabriel Atlantic col. 60011 grey
Metal base: OPM6 RAL 9017 traffic black painted

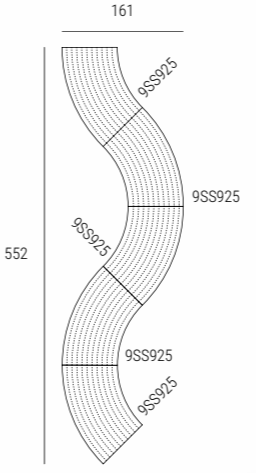



STRIPES composition cm 370x370
9SS925 cm 73x42,5h
9SS505 cm 73x101h
Fabric: cat. B art. Gabriel Atlantic col. 60011 grey and 68054 green
Metal base: OPM6 RAL 9017 traffic black painted

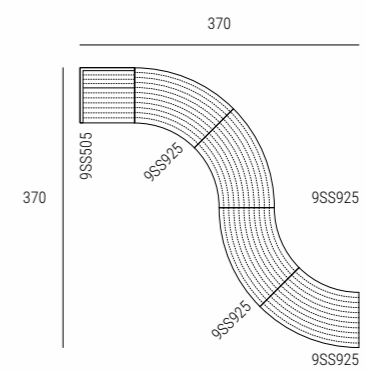

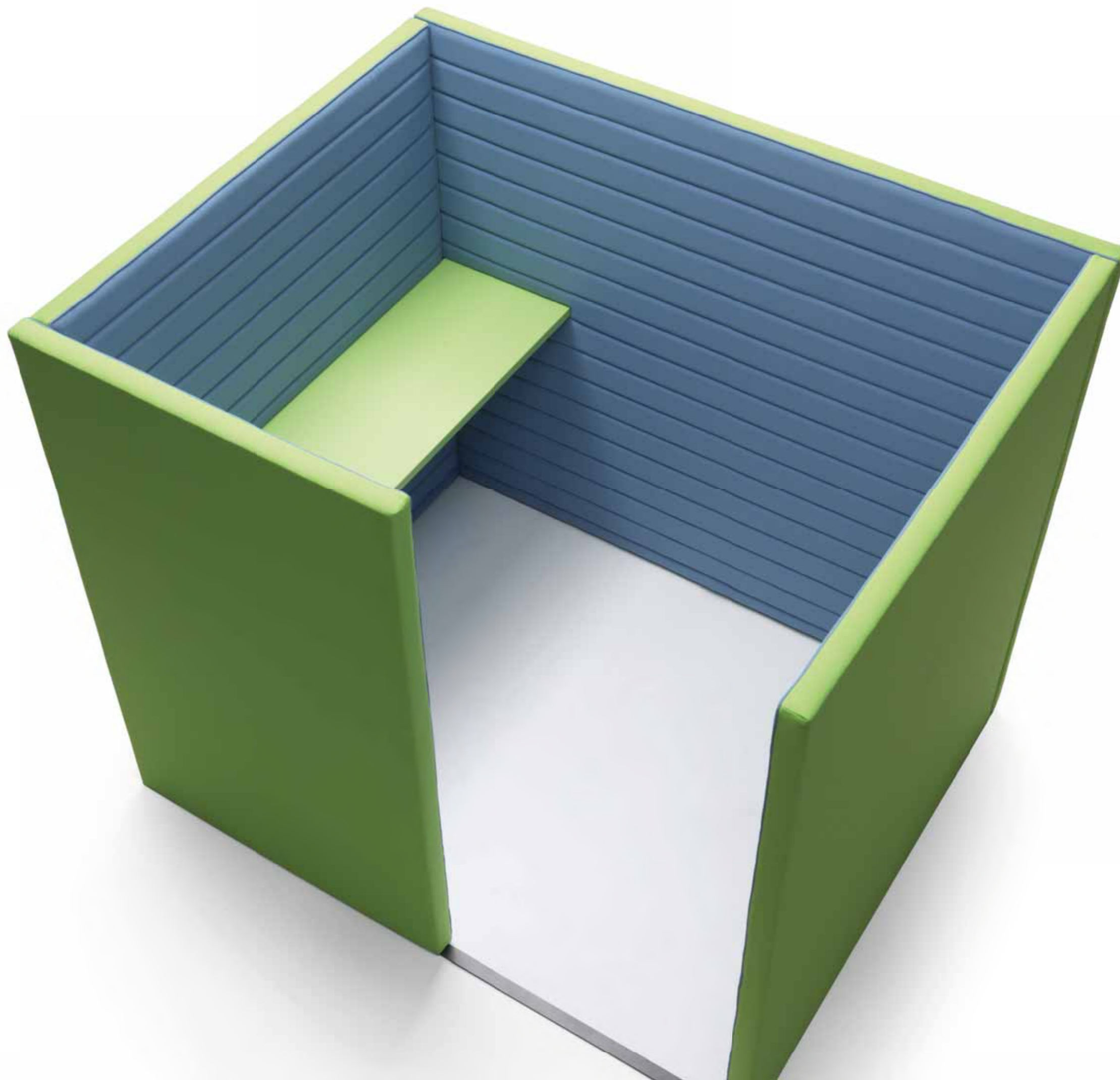

STRIPES composition
95x912 cm 125x156x133h
Fabric: External side: cat. B art. Camira Xtreme Plus col. YS156 Madura
Internal quilted side: cat. B art. Camira Xtreme Plus col. YS095 Steel
Table top: Fundermax HPL, apple green

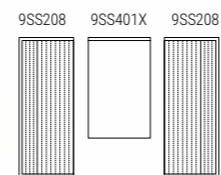
STRIPES**9SS913 cm 100x73x215h**Fabric: External side: cat. B art. Camira Xtreme Plus col. YS156 Madura
Internal quilted side: cat. B art. Camira Xtreme Plus col. YS095 Steel
Table top: Fundermax HPL, apple green**9SS803** Bachmann Power Frame electric module

> **STRIPES** composition L
9SS208 cm 185x73x133h

Fabric:
 External side:
 cat. B art. Camira Xtreme Plus col. YS156 Madura
 Internal quilted side:
 cat. B art. Camira Xtreme Plus col. YS095 Steel
 Metal base:
 OPM6 RAL 9017 traffic black painted metal
9SS401X table **cm 82x133x133h**
 Fundermax HPL, apple green

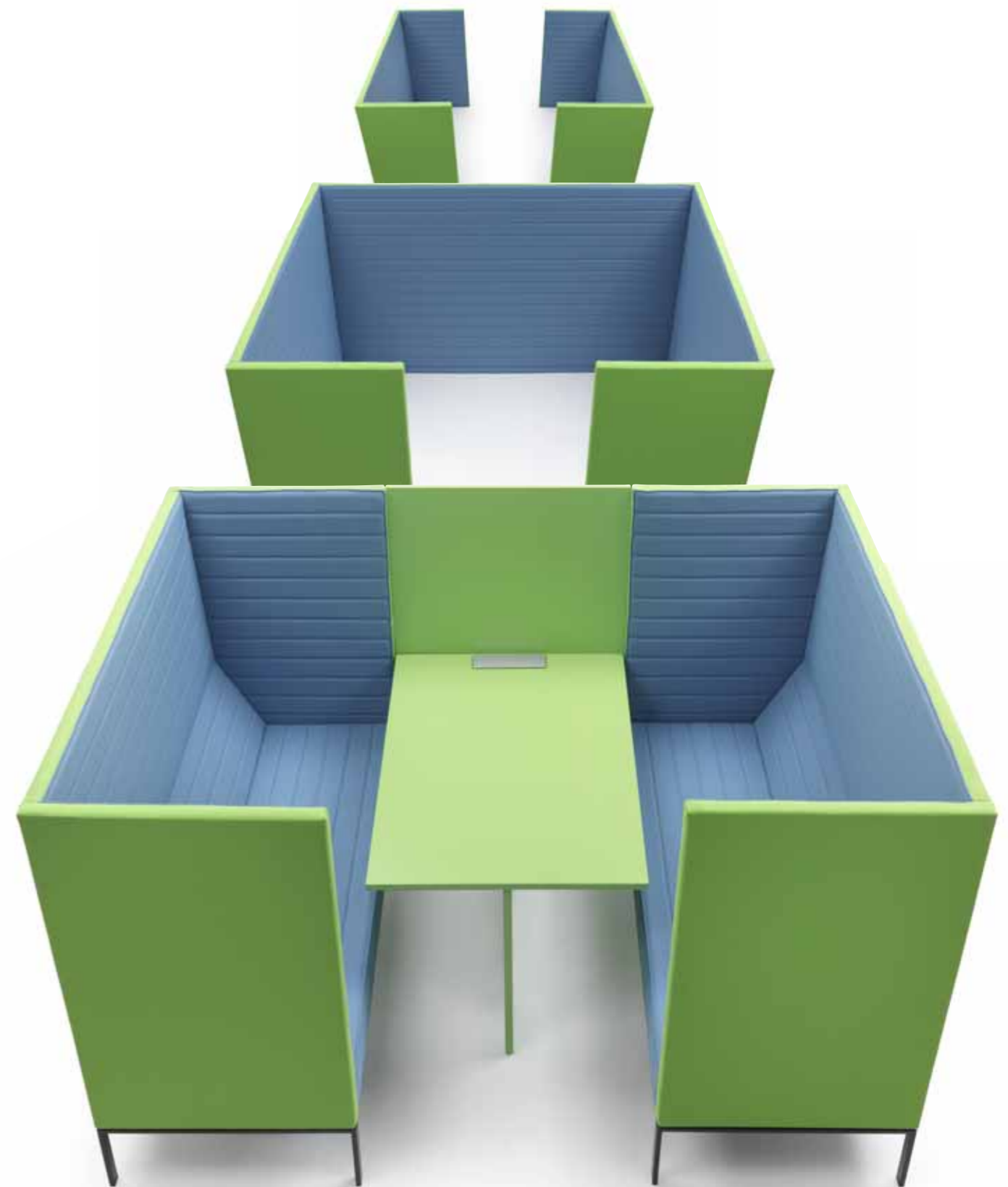
9SS803 Bachmann Power Frame electric module**STRIPES****9SS914 cm 185x73x133h (x2)**Fabric: External side: cat. B art. Camira Xtreme Plus col. YS156 Madura
Internal quilted side: cat. B art. Camira Xtreme Plus col. YS095 Steel**9SS915 cm 228x185x133h**Fabric: External side: cat. B art. Camira Xtreme Plus col. YS156 Madura
Internal quilted side: cat. B art. Camira Xtreme Plus col. YS095 Steel



STRIPES box with led lighting
95S916 cm 228x185x223h
Fabric: cat. B Camira Xtreme Plus col. Tonga YS160
Metal base: OPM7 RAL 9016 white painted metal
Table: white HPL

95S803 Bachmann Power Frame electric module

Cable channel available on demand



<
Detail of STRIPES box with led lighting
9SS916 cm 228x185x223h



STRIPES box
9SS917 cm **228x185x133h**
Fabric: cat. B Camira Xtreme Plus col. Tonga YS160
Metal base: OPM7 RAL 9016 white painted metal
Table: white HPL
9SS803 Bachmann Power Frame electric module



STRIPES box with led lighting
9SS921 cm 228x73x223h
Fabric: cat. F art. Camira Oxygen BA056 Flexor
Metal base: OPM7 RAL 9016 white painted metal
Table: white HPL

9SS803 Bachmann Power Frame electric module

STRIPES composition K cm 185 x 580
9SS207 cm 185x73x133h
9SS909 cm 73x133h
9SS906 cm 73x133h
9SS907 cm 73x133h
 Fabric: cat. H art. Kvadrat Steelcut Trio col. 853
 Metal base: OPM6 RAL 9017 traffic black painted
9SS809 low shelf
 Birch plywood natural oak veneered

9SS805 Belux lamp
9SS802 Schulte Evoline socket

PIVOT swivel chair
9PIV101 cm 55.5x54x80h
 Fabric: cat. B art. Gabriel Atlantic col. 61163
 and cat. H art. Kvadrat Steelcut Trio col. 853
 Oak structure in natural oak OPR4

PIVOT table
7PIV101 ø cm 60x43/61h
 OPR4 natural oak

PIVOT table
7PIV102 ø cm 78x43/74h
 OPR4 natural oak

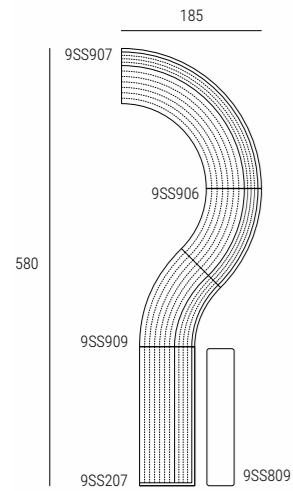

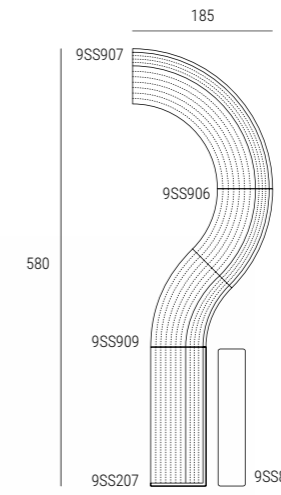

STRIPES composition K cm 185 x 580
9SS207 cm 185x73x133h
9SS909 cm 73x133h
9SS906 cm 73x133h
9SS907 cm 73x133h
 Fabric: cat. H art. Kvadrat Steelcut Trio col. 853
 Metal base: OPM6 RAL 9017 traffic black painted
9SS809 low shelf
 Birch plywood natural oak veneered

9SS805 Belux lamp
9SS802 Schulte Evoline socket

PIVOT swivel chair
9PIV101 cm 55.5x54x80h
 Fabric: cat. B art. Gabriel Atlantic col. 61163
 and cat. H art. Kvadrat Steelcut Trio col. 853
 Oak structure in natural oak OPR4

PIVOT table
7PIV101 ø cm 60x43/61h
 OPR4 natural oak

PIVOT table
7PIV102 ø cm 78x43/74h
 OPR4 natural oak



STRIPES box
9SS920 cm 228x145x133h
Fabric: cat. D art. Camira Main Line Flax col. 29
Table: OPR4 natural oak

9SS803 Bachmann Power Frame electric module



STRIPES sofas with castors
9SS208 cm 185x73x133h
Fabric: cat. B art. Gabriel Atlantic col. 67030
Metal base: OPM6 RAL 9017 traffic black painted with castors 9SS811
9SS102 server cm 60x30x62h

9SS804 Mobile lamp
9SS801 Bachmann Power Frame mobile electric module





STRIPES round composition
9SS907 cm 73x133 (x2)
9SS808 cm 73x133 (x2)
Fabric: cat. B art. Gabriel Atlantic col. 67030
Metal base: OPM7 RAL 9016 traffic white painted

9SS808 high shelves
HPL colour 1661

CHIA swivel armchairs
9CHI103A cm 58x53x77h
Fabric: cat. B art. Gabriel Atlantic col. 67030
Metal base A: OPM6 RAL 9017 traffic black painted



STRIPES armchairs
9SS107 cm 80x73x133h
Fabric: cat. B art. Camira Xtreme Plus col. Havana YS009
Metal base: OPM1 shiny chrome



> **STRIPES** swivel armchair
9SS108 cm 80x73x133h
Fabric: cat. B art. Camira Xtreme Plus
col. Havana YS009
Swivel metal base: OPM1 shiny chrome



STRIPES



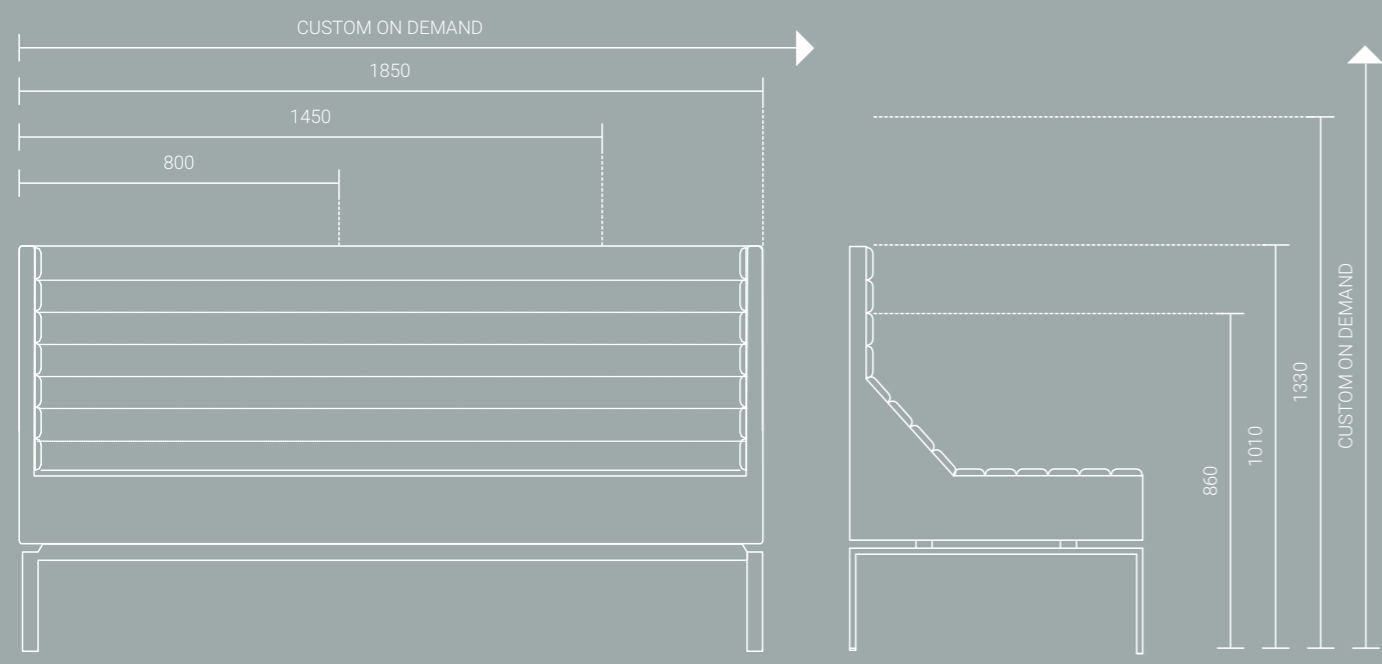

DESIGN JÉRÔME GAUTHIER
2009

Available widths

Available heights

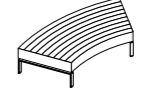

Accessories

- 
9RL112
 L63 H33
 Feather cushion
 without band
- 
9SS101
 L145 P73 H42,5
- 
9SS103
 L185 P73 H42,5
- 
9SS925
 P73 H42,5
 Round bench element
- 
9SS102
 L60 P30 H62
 Horizontally adjustable
 server with metal top
- 
9SS104
 L73 P73 H37
 Small table with
 transparent glass top

STRIPES

DESIGN JÉRÔME GAUTHIER
2009

H101

Sofas

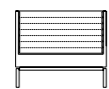
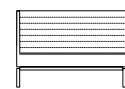
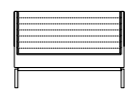
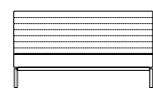
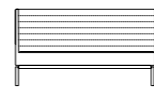
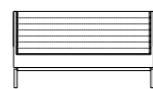
**9SS112**
L80 P73 H101**9SS114**
L120 P73 H101**9SS113**
L80 P73 H101
Swivel armchair**9SS505**
L73 P73 H101
Corner element**9SS201**
L145 P73 H101**9SS202**
L145 P73 H101**9SS204**
L145 P73 H101**9SS209**
L185 P73 H101**9SS210**
L185 P73 H101**9SS212**
L185 P73 H101

H133

Sofas

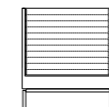
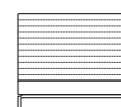
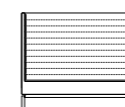
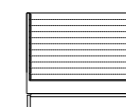
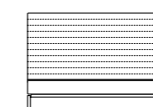
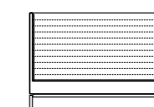
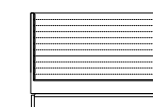
**9SS107**
L80 P73 H133**9SS304**
L120 P73 H133**9SS108**
L80 P73 H133
Swivel armchair**9SS401**
L73 P73 H133
Corner element**9SS301**
L145 P73 H133**9SS303**
L145 P73 H133**9SS305**
L145 P73 H133**9SS205**
L185 P73 H133**9SS207**
L185 P73 H133**9SS208**
L185 P73 H133

STRIPES

DESIGN JÉRÔME GAUTHIER
2009

H101

Sofas

With an angle of 60°

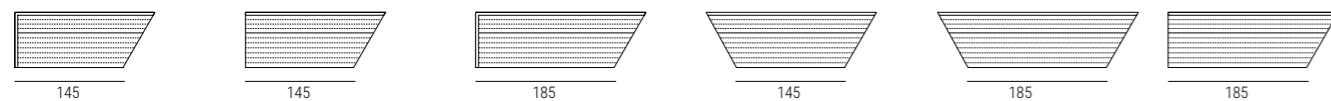
**9SS612**
L185 P73 H101**9SS613**
L185 P73 H101**9SS614**
L225 P73 H101**9SS615**
L225 P73 H101**9SS627**
L265 P73 H101**9SS616**
L225 P73 H101

With an angle of 45°

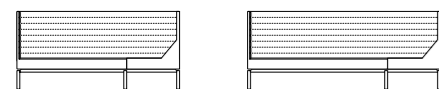
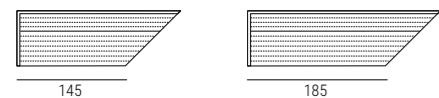
**9SS600**
L215 P73 H101**9SS602**
L255 P73 H101

H133

Sofas

With an angle of 60°

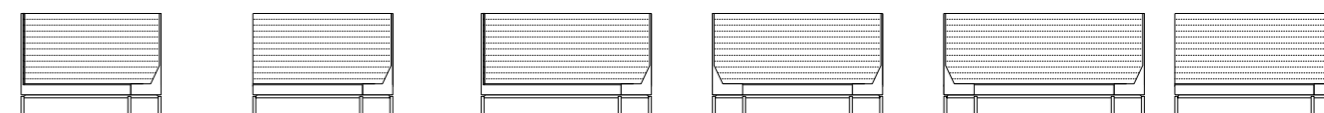
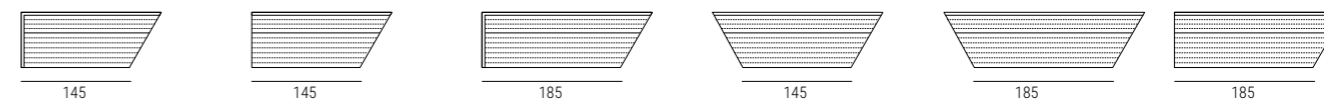
**9SS620**
L185 P73 H133**9SS624**
L185 P73 H133**9SS622**
L225 P73 H133**9SS625**
L225 P73 H133**9SS628**
L265 P73 H133**9SS626**
L225 P73 H133

With an angle of 45°

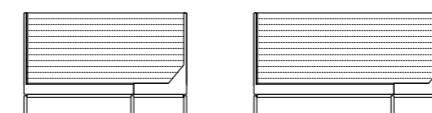
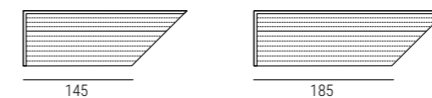
**9SS608**
L215 P73 H133**9SS610**
L255 P73 H133

STRIPES

DESIGN JÉRÔME GAUTHIER
2009

H101

H133

Round elements

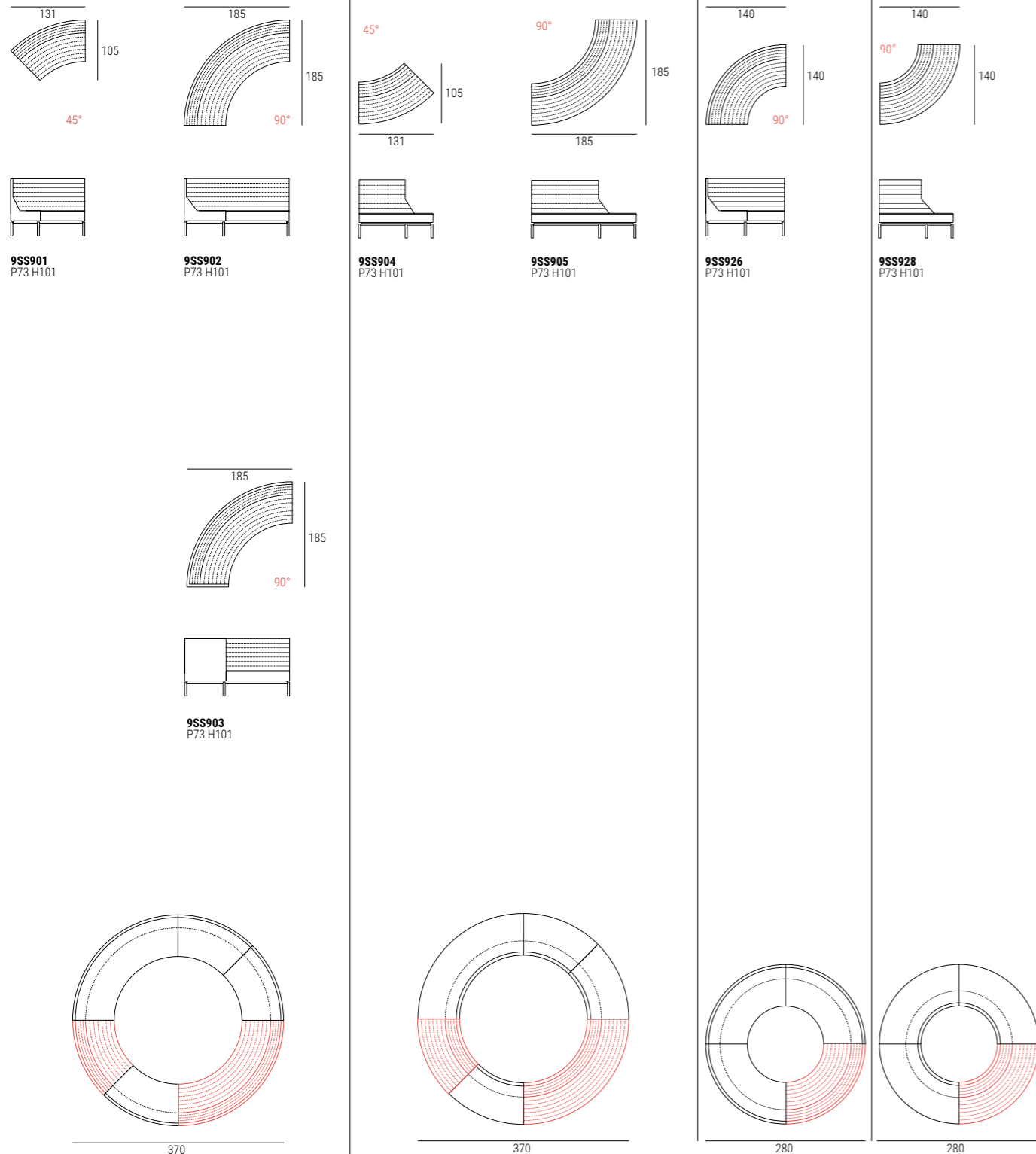

Round elements

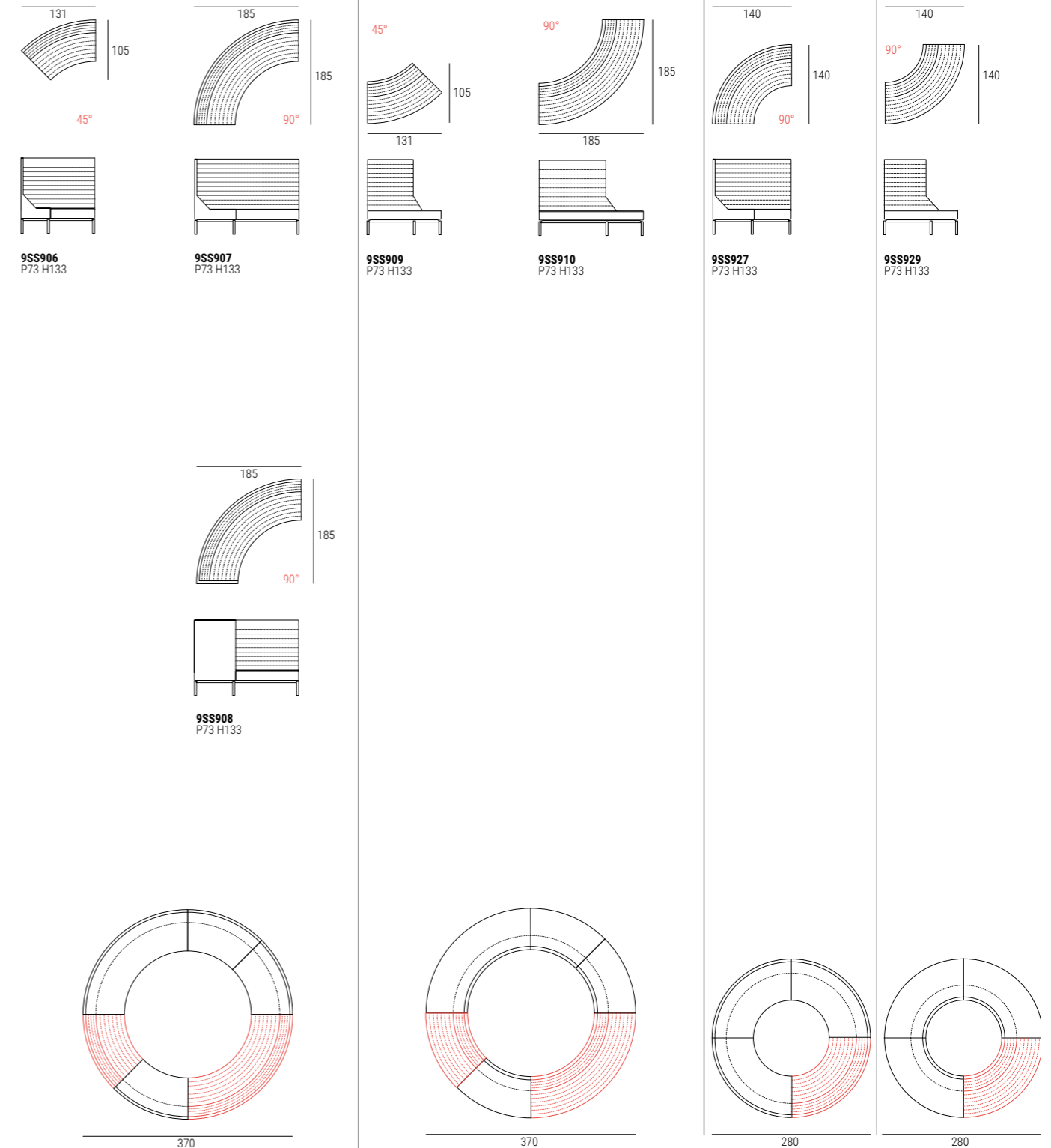

STRIPES

DESIGN JÉRÔME GAUTHIER
2009

H133

Tables
25 mm thick

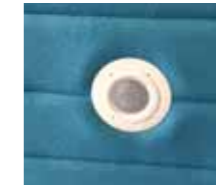

* Activation of led lighting through motion detector (standard version) or, on demand, by means of a switch.

Tables

Box

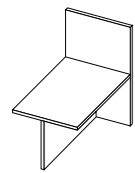

9SS401X
L82 P133 H133
Table

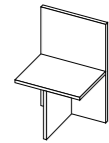

9SS402X
L82 P55 H133
Table

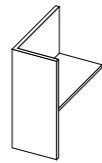

9SS403X
L73 P41 H133
Table

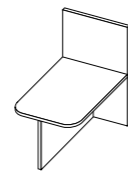

9SS404X
L82 P133 H133
Table

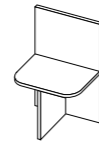

9SS405X
L82 P55 H133
Table

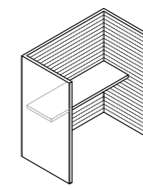

9SS911
L125 P73 H133

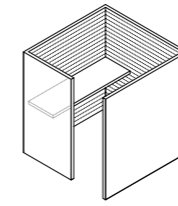

9SS912
L125 P156 H133

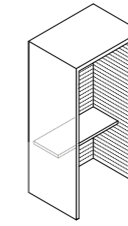

9SS913
L100 P73 H215

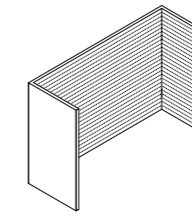

9SS914
L185 P73 H133

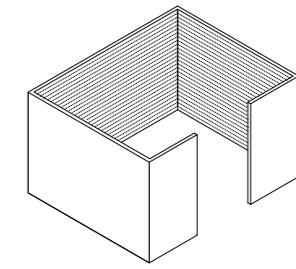

9SS915
L228 P185 H133

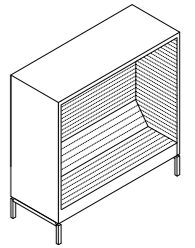

9SS924
L185 P73 H183

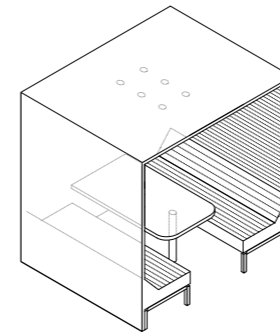

9SS916 *
L228 P185 H223
Table size L82 P133

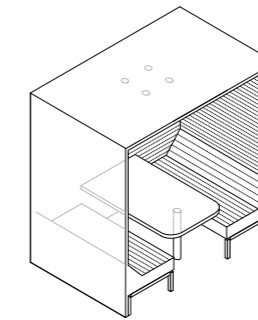

9SS923 *
L228 P145 H223
Table size L82 P133

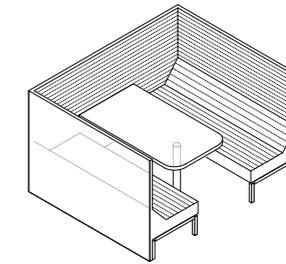

9SS917
L228 P185 H133
Table size L82 P133

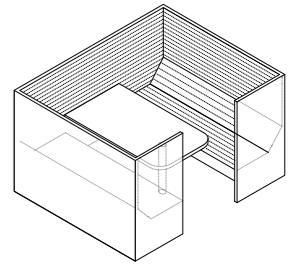

9SS918
L228 P185 H133
Table size L82 P133

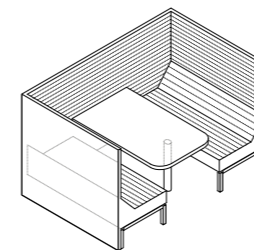

9SS919
L228 P145 H133
Table size L82 P133

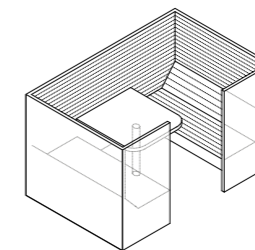

9SS920
L228 P145 H133
Table size L82 P90

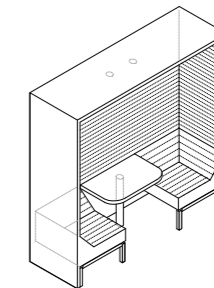

9SS921 *
L228 P73 H223
Table size L82 P55

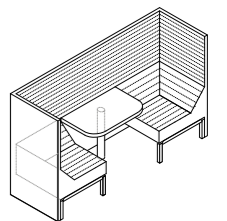

9SS922
L228 P73 H133
Table size L82 P55

STRIPES

DESIGN JÉRÔME GAUTHIER
2009

Optionals



9SS801 *
L11 P5 H31
Bachmann power frame mobile module



9SS802 **
L10 H10
Schulte Evoline



9SS803 *
L26 x H9
Bachmann power frame module



9SS804
L27 P16 H7,5 (totaleH24)
Mobile lamp



9SS805
ø14 H32
Beluxe lamp



9SS806
L42 P20 H24
Mobile shelf

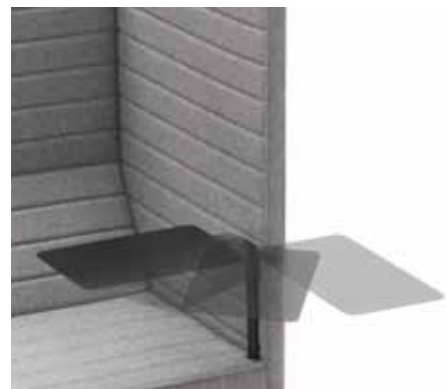

9SS810
L25 P40
Mobile writing shelf



9SS811
Castors

The Bachmann Power Frame electric module is available in the standard version with 2 Schuko and 2 USB sockets, in accordance with the European standards; on demand, it is also available according to the Swiss or British standards or it can be customized with different combinations of internal modules with a price increase.

The standard kit is available with 1 Schuko, 1 USB and 1 RJ45 socket, exclusively according to the European standards.

Optionals



9SS807 *
L24 x H7,5
Bachmann power frame module



9SS808
P36 H104
High shelf for sofas



9SS809
P36 H74
Low shelf for sofas

Finishes

Standard base finishes

Code RAL 9017 traffic black painted metal OPM6	Code RAL 9016 traffic white painted metal OPM7	Code Classic bronze painted metal OPM9	Code Golden beach painted metal OPM10	Code Gold pearl painted metal OPM11	Code RAL 9006 white aluminium painted metal	Code Anodyc. Bronze metal OPM18

Optional base finishes

Code Shiny chrome metal OPM1	Code Brushed matt chrome metal OPM2	Code Brushed matt dark grey metal OPM3	Code Brushed copper metal OPM12	Code Brushed antique brass metal OPM13	Code Shiny black chrome metal OPM14	Code Brushed antique gold metal OPM15	Code Shiny brass chrome metal OPM16	Code Bronze metal OPM17	Code Metal painted in RAL Classic colors OPM8

STRIPES

DESIGN JÉRÔME GAUTHIER
2009

Compositions

COMPOSITION A

9SS614 x4
Sofa
9SS809 x2
Low shelf

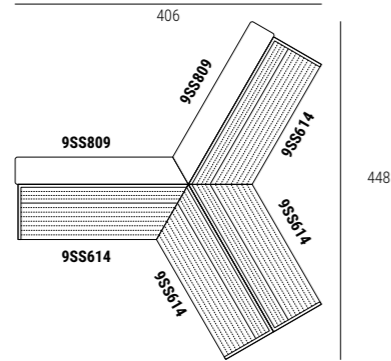

Compositions

COMPOSITION D

9SS210 x2
Sofa
9SS809 x2
Low shelf

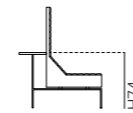
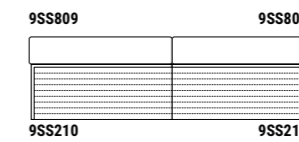

COMPOSITION B

9SS908 x2
Sofa
9SS907
Sofa

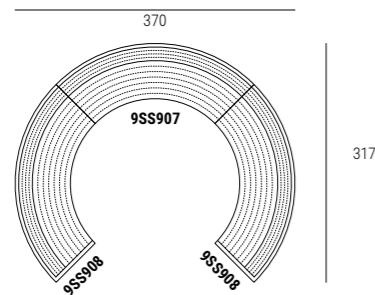

COMPOSITION E

9SS401 x2
Sofa
9SS405X
Table

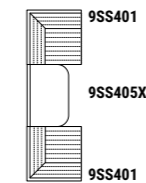

COMPOSITION C with high shelf

9SS208 x2
Sofa
9SS808
High shelf
9SS404X
Table

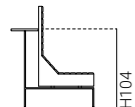
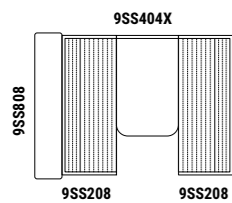

COMPOSITION C with low shelf

9SS208 x2
Sofa
9SS809
Low shelf
9SS404X
Table

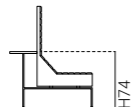
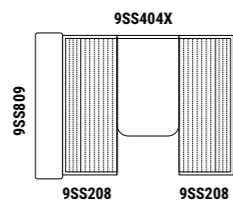

COMPOSITION F

9SS610 x2
Sofa
9SS808
High shelf

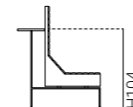
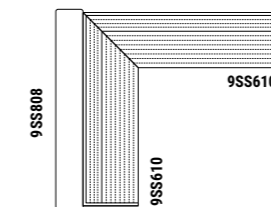

STRIPES

DESIGN JÉRÔME GAUTHIER
2009

Compositions

COMPOSITION G

9SS401
Sofa
9SS403X
Table

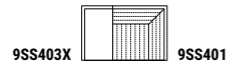

COMPOSITION H

9SS401 x2
Sofa
9SS402X
Table

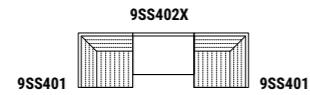

COMPOSITION J

9SS614 x2
Sofa
9SS627 x1
Sofa
9SS809 x3
Low shelf

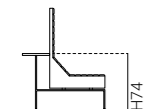
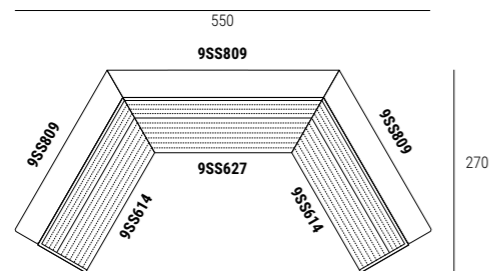

Compositions

COMPOSITION K

9SS907
Sofa
9SS906
Sofa
9SS909
Sofa
9SS207
Sofa
9SS809
Low shelf

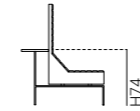
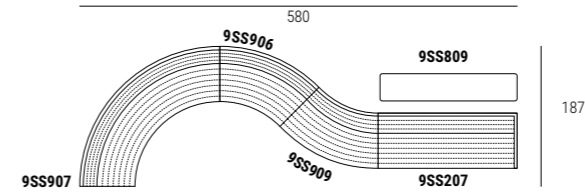

COMPOSITION L

9SS208 x2
Sofa
9SS401X
Table

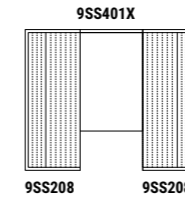

COMPOSITION M

9SS925 x5
Round bench element

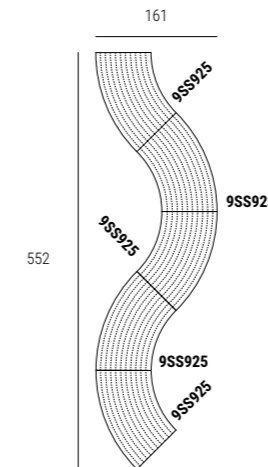

STRIPES

DESIGN JÉRÔME GAUTHIER
2009

La collezione STRIPES, creata dal designer Jérôme Gauthier, è ispirata alle tipiche panchine a doghe in legno orizzontali utilizzate nei parchi pubblici parigini ed è caratterizzata dalla trapuntatura a righe (da cui viene il nome "Stripes").

Stripes è un modello testato fonooassorbente ed è conforme ai test BIFMA statunitensi.

Per favorire l'ergonomia e la comodità del prodotto, lo schienale è dotato di un poggiaerani con un angolo di inclinazione di ca. 22° in modo tale che non sono necessari cuscinetti per garantire il comfort.

Seduta, schienale e braccioli sono composti da un fusto in pannelli di multistrato da 20 e 40 mm di prima scelta. La resistenza del fusto è garantita da una costruzione ad incastri che offre elevate garanzie di tenuta. La seduta, priva di cinghie elastiche intrecciate, è in poliuretano espanso CM 40/P kg/m³ 5,9 kPa e rinforzi con SR75 Kg/m³ 15,5 kPa.

Schienale e poggiaerani sono in poliuretano espanso CM 40 kg/m³ 5,9 kPa.

Il fusto e i braccioli sono rivestiti in poliuretano espanso, con una densità di 40 kg/m³ 5,9 kPa e 75 kg/m³ 15,5 kPa.

Per garantire la durabilità del prodotto nel tempo nei punti maggiormente soggetti a deformazione vengono utilizzati degli aggregati di poliuretano espanso della densità complessiva di 200 kg/m³, sotto cui è montata una piastra di metallo da 40 x 5 mm.

La parte esterna del fusto è inoltre rivestita in fibra termolegata di 250 gr.

I braccioli sono fissati tramite bulloni e baionette.

Il poliuretano espanso è sempre ignifugo CMHR (Combustion Modified High Resilient) e risponde alle norme British Standard (BS), Cal 117, Classe 11M, nonché, su richiesta, ad altri standard (per esempio le norme tedesche DIN o le norme francesi NF).

Le caratteristiche righe ("stripes" in inglese), orizzontali o verticali, sono ottenute tramite una trapuntatura che accoppia non solo il rivestimento (tessuto, finta pelle o pelle) e il dacron, ma anche uno strato di gomma con uno spessore di 1 cm. Ogni riga è alta 8 cm.

Il rivestimento del modello Stripes è sempre fisso, sia in tessuto che in pelle e finta pelle.

The STRIPES collection, created by the designer Jérôme Gauthier, was inspired by the typical wooden horizontal slat benches used in public parks in Paris and is characterized by the stripes quilting, that is where the name "Stripes" comes from.

Stripes is a tested sound absorbing model and complies with the U.S. BIFMA standards.

In order to enhance the ergonomics and the comfort of the product, the backrest is equipped with a low back support with an inclination angle of about 22 degrees, so that no further cushions are needed to ensure the sofa comfort.

Seat, backrest and arms have a frame made of 20 and 40 mm multi-ply wooden panels of the highest quality.

The frame resistance is guaranteed by a joint construction.

The seat, which is not equipped with interwoven elastic belts, is made of polyurethane foam CM 40/P kg/m³ 5,9 kPa, with supports in foam SR75 Kg/m³ 15,5 kPa.

Backrest and low back support are made of polyurethane foam CM 40 kg/m³ 5,9 kPa.

Frame and arms are upholstered with polyurethane foam with a density of 40 kg/m³ 5,9 kPa and 75 kg/m³ 15,5 kPa.

The presence of polyurethane aggregates with an overall density of 200 kg/m³, under which there is a 40 x 5 mm metal plate, ensure the product durability over time in the areas which are more subject to deformation.

The external frame side is also lined with a 250 gr. thermo-bonded fibre.

The arms are fixed by means of bolts and bajonet joints.

The polyurethane foam is always CMHR fire-retardant (Combustion Modified High Resilient) according to the British Standard regulations (BS), CAL 117, Class 11M, or, on demand, according to other regulations (such as the German DIN or the NF French regulations).

The typical stripes, which can be horizontal or vertical, are obtained through a quilting process which couples not only the cover material – fabric, artificial leather or leather, wich dacron, but also a 1 cm thick foam layer. Each stripe is 8 cm high.

Fabric, artificial leather and leather covers are always fixed.

Die Kollektion STRIPES, gezeichnet vom Designer Jérôme Gauthier, lehnt sich an die typischen Fassdaubenbänken in den Pariser Parks und ist durch die Streifenabsteppung – daher der Name «Stripes», gekennzeichnet.

Stripes ist ein schallabsorbierendes, getestetes Modell und besteht die US-BIFMA Tests.

Die Ergonomie und der Sitzkomfort des Produkts werden durch die in der Rückenlehne eingearbeitete Nierenschütze gefördert. Diese hat eine Neigung von ca. 22°, so dass zusätzliche Kissen nicht benötigt werden, um die Bequemlichkeit und den Sitzkomfort dieses Produkts zu gewährleisten.

Sitz, Rückenlehne und Seitenteile bestehen aus einem Gestell aus Schichtholzplatten mit einer Dicke von 20 und 40 mm von höchster Qualität.

Die Haltbarkeit des Gestells wird durch eine Steckkonstruktion gewährleistet.

Die Sitzfläche, ohne geflochtene Gummigurtung, besteht aus Polyurethan-Schaumstoff CM 40/P kg/m³ 5,9 kPa, mit Verstärkung in SR75 Kg/m³ 15,5 kPa.

Rückenlehne und Nierenschütze sind mit Polyurethan-Schaumstoff CM 40 kg/m³ 5,9 kPa gepolstert. Gestell und Seitenteile sind mit Polyurethan-Schaumstoff mit einer Dicke von 40 kg/m³ 5,9 kPa und 75 kg/m³ 15,5 kPa gepolstert.

Die Verwendung von Polyurethan-Schaumstoff-Aggregaten mit einer Gesamtdichte von 200 Kg/m³ in den Punkten, die der Verformung mehr ausgesetzt sind, sichert die Dauerhaftigkeit des Produktes für lange Zeit. Darunter wird zusätzlich eine Metallplatte 40 x 5 mm befestigt.

Die Aussenseiten des Gestells sind zusätzlich mit einer Ummantelung aus thermogebundenen Fasern mit Gewicht 250 Gr. ausgestattet.

Die Seitenteile sind mittels Schrauben und Bajonettverschlüssen befestigt.

Der Polyurethan-Schaumstoff ist immer schwerentflammbar CMHR (Combustion Modified High Resilient), gemäß British Standard (BS), Cal 117, Klasse 11M, oder, auf Anfrage, gemäß anderen Standards, wie beispielsweise den deutschen DIN-Normen oder den französischen NF-Normen.

Die typischen Streifen – Stripes –, die horizontal oder vertikal ausgeführt werden können, erhält man nicht nur durch die Verbindung des Bezugsmaterials – Stoff, Leder oder Kunstleder – mit Dacron, sondern es wird hier auch Schaumstoff mit einer Dicke von 1 cm eingearbeitet. Jeder Streifen ist 8 cm hoch.

Die Modelle der Serie Stripes sind immer festbezogen.

La collection STRIPES, créée par le designer Jérôme Gauthier, est inspirée par les banquettes à lattes de bois horizontales utilisées dans les parcs publics parisiens et est caractérisée par le matelassage à rayures (d'où le nom "Stripes").

Stripes est un modèle testé insonore et est conforme aux tests étasuniens BIFMA.

Pour faciliter l'ergonomie et le confort du produit, le dossier est équipé d'un support lombaire avec un angle d'inclinaison d'environ 22° de telle sorte que des coussins lombaires ne sont pas nécessaires pour assurer le confort.

L'assise, le dossier et les accoudoirs sont composés d'une carcasse en panneaux de multiplis de 20 et 40 mm de premier choix.

La résistance de la carcasse est assurée par une construction avec des joints qui offre des garanties élevées de durée de vie.

L'assise, qui n'a pas de sangles élastiques entrecroisées, est en mousse de polyuréthane CM 40/P kg/m³ 5,9 kPa et renforts avec SR75 kg/m³ 15,5 kPa.

Le dossier et les accoudoirs sont en mousse de polyuréthane CM 40 kg/m³ 5,9 kPa.

La carcasse et les accoudoirs sont revêtus de mousse de polyuréthane avec une densité de 40 kg/m³ 5,9 kPa et 75 kg/m³ 15,5 kPa.

Afin d'assurer la durabilité du produit dans le temps au niveau des points les plus sujets à la déformation, des agrégats de mousse de polyuréthane d'une densité globale de 200 kg/m³ sont utilisés, sous lesquels est montée une plaque métallique de 40 x 5 mm.

En plus, l'extérieur de la carcasse est revêtu de dacron de 250 grammes.

Les accoudoirs sont fixés à l'aide de boulons et baionnettes.

La mousse de polyuréthane est toujours ignifuge CMHR (Combustion Modified High Resilient) et répond aux normes British Standard (BS), Cal 117, Classe 11M, ainsi que, sur demande, à d'autres normes (par exemple les normes allemandes DIN ou les normes françaises NF).

Les rayures ("stripes" en anglais) caractéristiques, horizontales ou verticales, sont obtenues grâce à un matelassage qui couple non seulement le revêtement (tissu, similicuir ou cuir) et le dacron, mais aussi une couche de mousse de polyuréthane avec une épaisseur d'1 cm. Chaque rayure est haute 8 cm.

Le revêtement du modèle Stripes est toujours fixe, aussi bien en tissu qu'en similicuir qu'en cuir.

Ottimale caratteristica della collezione STRIPES è la presenza di una stecca in legno orizzontale utilizzata nei parchi pubblici parigini ed è caratterizzata dalla trapuntatura a righe (da cui viene il nome "Stripes").

Stripes è un modello testato fonooassorbente ed è conforme ai test BIFMA statunitensi. Per favorire l'ergonomia e la comodità del prodotto, lo schienale è dotato di un poggiaerani con un angolo di inclinazione di ca. 22° in modo tale che non sono necessari cuscinetti per garantire il comfort.

Seduta, schienale e braccioli sono composti da un fusto in pannelli di multistrato da 20 e 40 mm di prima scelta. La resistenza del fusto è garantita da una costruzione ad incastri che offre elevate garanzie di tenuta. La seduta, priva di cinghie elastiche intrecciate, è in poliuretano espanso CM 40/P kg/m³ 5,9 kPa e rinforzi con SR75 Kg/m³ 15,5 kPa.

Schienale e poggiaerani sono in poliuretano espanso CM 40 kg/m³ 5,9 kPa. Il fusto e i braccioli sono rivestiti in poliuretano espanso, con una densità di 40 kg/m³ 5,9 kPa e 75 kg/m³ 15,5 kPa.

Per garantire la durabilità del prodotto nel tempo nei punti maggiormente soggetti a deformazione vengono utilizzati degli aggregati di poliuretano espanso della densità complessiva di 200 kg/m³, sotto cui è montata una piastra di metallo da 40 x 5 mm.

La parte esterna del fusto è inoltre rivestita in fibra termolegata di 250 gr.

I braccioli sono fissati tramite bulloni e baionette.

Il poliuretano espanso è sempre ignifugo CMHR (Combustion Modified High Resilient) e risponde alle norme British Standard (BS), Cal 117, Classe 11M, nonché, su richiesta, ad altri standard (per esempio le norme tedesche DIN o le norme francesi NF).

Le caratteristiche righe ("stripes" in inglese), orizzontali o verticali, sono ottenute tramite una trapuntatura che accoppia non solo il rivestimento (tessuto, finta pelle o pelle) e il dacron, ma anche uno strato di gomma con uno spessore di 1 cm. Ogni riga è alta 8 cm.

Il rivestimento del modello Stripes è sempre fisso, sia in tessuto che in pelle e finta pelle.

Per favorire l'ergonomia e la comodità del prodotto, lo schienale è dotato di un poggiaerani con un angolo di inclinazione di ca. 22° in modo tale che non sono necessari cuscinetti per garantire il comfort.

Seduta, schienale e braccioli sono composti da un fusto in pannelli di multistrato da 20 e 40 mm di prima scelta. La resistenza del fusto è garantita da una costruzione ad incastri che offre elevate garanzie di tenuta. La seduta, priva di cinghie elastiche intrecciate, è in poliuretano espanso CM 40/P kg/m³ 5,9 kPa e rinforzi con SR75 Kg/m³ 15,5 kPa.

Schienale e poggiaerani sono in poliuretano espanso CM 40 kg/m³ 5,9 kPa. Il fusto e i braccioli sono rivestiti in poliuretano espanso, con una densità di 40 kg/m³ 5,9 kPa e 75 kg/m³ 15,5 kPa.

Per garantire la durabilità del prodotto nel tempo nei punti maggiormente soggetti a deformazione vengono utilizzati degli aggregati di poliuretano espanso della densità complessiva di 200 kg/m³, sotto cui è montata una piastra di metallo da 40 x 5 mm.

La parte esterna del fusto è inoltre rivestita in fibra termolegata di 250 gr.

I braccioli sono fissati tramite bulloni e baionette.

Il poliuretano espanso è sempre ignifugo CMHR (Combustion Modified High Resilient) e risponde alle norme British Standard (BS), Cal 117, Classe 11M, nonché, su richiesta, ad altri standard (per esempio le norme tedesche DIN o le norme francesi NF).

Le caratteristiche righe ("stripes" in inglese), orizzontali o verticali, sono ottenute tramite una trapuntatura che accoppia non solo il rivestimento (tessuto, finta pelle o pelle) e il dacron, ma anche uno strato di gomma con uno spessore di 1 cm. Ogni riga è alta 8 cm.

Il rivestimento del modello Stripes è sempre fisso, sia in tessuto che in pelle e finta pelle.

Il rivestimento del modello Stripes è sempre fisso, sia in tessuto che in pelle e finta pelle.

Il rivestimento del modello Stripes è sempre fisso, sia in tessuto che in pelle e finta pelle.

Il rivestimento del modello Stripes è sempre fisso, sia in tessuto che in pelle e finta pelle.

Il rivestimento del modello Stripes è sempre fisso, sia in tessuto che in pelle e finta pelle.

Il rivestimento del modello Stripes è sempre fisso, sia in tessuto che in pelle e finta pelle.

Il rivestimento del modello Stripes è sempre fisso, sia in tessuto che in pelle e finta pelle.

Il rivestimento del modello Stripes è sempre fisso, sia in tessuto che in pelle e finta pelle.

Il rivestimento del modello Stripes è sempre fisso, sia in tessuto che in pelle e finta pelle.

Il rivestimento del modello Stripes è sempre fisso, sia in tessuto che in pelle e finta pelle.

Il rivestimento del modello Stripes è sempre fisso, sia in tessuto che in pelle e finta pelle.

Il rivestimento del modello Stripes è sempre fisso, sia in tessuto che in pelle e finta pelle.

Il rivestimento del modello Stripes è sempre fisso, sia in tessuto che in pelle e finta pelle.

Il rivestimento del modello Stripes è sempre fisso, sia in tessuto che in pelle e finta pelle.

Il rivestimento del modello Stripes è sempre fisso, sia in tessuto che in pelle e finta pelle.

Il rivestimento del modello Stripes è sempre fisso, sia in tessuto che in pelle e finta pelle.

Il rivestimento del modello Stripes è sempre fisso, sia in tessuto che in pelle e finta pelle.

Il rivestimento del modello Stripes è sempre fisso, sia in tessuto che in pelle e finta pelle.

Il rivestimento del modello Stripes è sempre fisso, sia in tessuto che in pelle e finta pelle.

Il rivestimento del modello Stripes è sempre fisso, sia in tessuto che in pelle e finta pelle.